

HELP

TRIMBLE® ACCESS™  
SOFTWARE

ROADS

Version 2.21  
Revision A  
June 2013



# Table of Contents

<b>Introduction Roads.....</b>	<b>1</b>
Introduction.....	1
Interacting With Other Applications.....	3
<b>Job Operations.....</b>	<b>5</b>
Jobs.....	5
Properties of Job.....	6
Review Job.....	7
Point Manager.....	11
Map.....	18
Using the Map for Common Tasks.....	21
Select points.....	25
Units.....	26
Cogo Settings.....	27
heading to sort the codes by that column.....	33
Additional Settings.....	33
<b>Define Roads.....</b>	<b>34</b>
Define.....	34
Trimble roads.....	34
Horizontal Alignment.....	36
Entry by Length / Coordinates.....	37
Entry by End station.....	39
Entry by PI.....	42
Transitions.....	43
Vertical Alignment.....	45
Entry by Vertical Points of Intersection (VPI).....	45
Entry by start and end points.....	47
Templates.....	48
Template Positions.....	50
Example Alignment.....	51
Non Tangent Horizontal Alignment Elements.....	53
Superelevation and Widening.....	54
Understanding superelevation rollover.....	55
Station equations.....	55
Additional Points.....	56
LandXML roads.....	56
GENIO roads.....	58
New string.....	59
Exclude Master String at Stakeout.....	61
Exporting GENIO files from 12d Model.....	61
<b>Survey Roads.....</b>	<b>62</b>
Stakeout - Roads.....	62
Staking Trimble Roads.....	66

# Table of Contents

## Survey Roads

Stakeout - Station and offset.....	67
Stakeout - Available Stations.....	70
Position relative to a Trimble or LandXML road.....	71
Nearest offset.....	72
Staking out a Side Slope Relative to an Alignment.....	75
Stakeout position from a file.....	77
Staking Roads from GENIO Files.....	79
Position relative to GENIO road.....	80
Stakeout along a string.....	81
Stakeout station on string.....	84
Staking relative to a secondary road.....	87
String interpolation.....	89
Staking Roads from LandXML Files.....	89
Editing Side Slopes.....	91
Specifying Construction Offsets.....	92
Cross Section View.....	95
Catch Point.....	96
Catch Point Staked Deltas.....	97
Defining a cross slope.....	98
Defining a subgrade.....	98
<b>File Transfer.....</b>	<b>100</b>
Report - Export Custom Format Files.....	100

# Introduction Roads

## Introduction

Welcome to the Roads software version 2.21 Help.

This help system makes it easy to find the information you need to effectively use the full power and capabilities of the Roads software.

For information that extends or updates this Help, refer to the Trimble Access Release Notes. Alternatively, visit the Trimble website ([www.trimble.com](http://www.trimble.com)) or contact your local Trimble dealer.

To use this application with other applications, see [Interacting with other applications](#).

### Contents

From the Trimble Access menu tap Roads to:

- [Manage](#) your jobs
- [Define](#) your road
- [Survey](#) your road
- [Report](#) your surveyed road

When defining, surveying and reporting your road the road file must be in the same folder as the current job.

### Managing jobs

From Roads tap *Jobs* to:

- [Create](#) a new job
- [Open](#) an existing job
- [Review](#) the current job
- Access the [Point manager](#)
- See the [Map](#)
- Review and edit the [Job properties](#)

### Defining a road

From Roads tap *Define* to define a road by one of three supported road formats:

- [Trimble](#) roads
- Roads derived from a [LandXML](#) file
- Roads derived from a [GENIO](#) file

### Trimble roads



Trimble roads can be:

- Defined by keyed-in components
- Uploaded from Trimble RoadLink software (a module of the Trimble Geomatics Office software).
- Uploaded via Trimble Link from a number of third party design packages including Autodesk Land Desktop, Autodesk Civil 3D, Bentley Inroads, and Bentley Geopak.
- Imported as a DC file.

Keyed-in roads are saved to the current project folder as 'road name'.rxl. Trimble roads are available for all jobs saved to the current project folder.

To use a file saved to the current project folder in another project, use Windows Explorer to copy or move the file to the appropriate project folder.

When a job that contains a road is uploaded to the Roads software, the road is removed from the job and a new file is created. This new file defines the road, it is renamed with the name of the road and the job, and has the filename extension ".rxl". The RXL file is saved to the same project folder as the job. If there is a road of the same name in this folder, it is overwritten by the uploaded road file.

When a DC file that contains a road is copied to the Roads software and then converted to a job, a new file that defines the road is created and renamed with the name of the road and the job, and the filename extension RXL. If an RXL file of the same name exists the RXL file has "(1)" added to the name. If the DC file is converted a second time, the resulting RXL file has "(2)" added to the file name, and so on, each time that file is converted.

For more information on defining a Trimble road, see [Trimble roads](#).

## **GENIO files**

GENIO files that define a road can be exported from a number of third party road design software packages, including Bentley MXROAD and [12D Model](#).

The file extension for the GENIO file must be \*.CRD, \*.INP, or \*.MOS. Files with the extension MOS are exported from [12D Model](#).

To use a GENIO file in Roads copy the file to the appropriate project folder on the controller. GENIO files are available for all jobs saved to the current project folder.

To use a file saved to the current project folder in another project, use Windows Explorer to copy or move the file to the appropriate project folder.

A GENIO file consists of a number of strings. When you define a road you select the appropriate strings from the GENIO file. The road name and the names of the selected strings are saved as a comment to the end of the GENIO file.

For more information on defining a road from a GENIO file, see [GENIO roads](#)

## **LandXML files**



LandXML files that define a road can be exported from a number of third-party road design software packages.

To use a LandXML file in Roads copy the file to the appropriate project folder on the controller. LandXML files are available for all jobs saved to the current project folder.

To use a file saved to the current project folder in another project, use Windows Explorer to copy or move the file to the appropriate project folder.

Before stakeout, you can review roads in a LandXML file using all the editing tools available for Trimble roads. If you edit the road definition, the road is saved as an RXL file. The original LandXML file remains in the current project folder.

For more information on reviewing and editing a road from a LandXML file, see [LandXML roads](#).

### **Surveying your road**

From Roads tap *Survey* to stake out a road or measure your position relative to a road.

For more information on surveying a Trimble road, see [Trimble roads](#).

For more information on surveying roads from LandXML files, see [LandXML roads](#).

For more information on surveying a roads from a GENIO file, see [GENIO roads](#).

### **Reporting a road**

From Roads tap *Reports* to generate a report for surveyed road data on the controller while in the field. Use these reports to check data in the field, or to transfer from the field to your client or to the office for further processing with the office software.

For more information on reporting a staked road, see [Reporting Roads](#).

### **Legal Notices**

© 2009 - 2013, Trimble Navigation Limited. All rights reserved. For full trademark and other legal information, refer to the [Trimble Access Help](#).

## **Interacting With Other Applications**

You can run more than one application at a time and easily switch between them. For example, you can switch between functions in *Roads*, *Tunnels*, *Mines*, and *General Survey*.

To run more than one application at a time, use the Trimble button or Trimble icon in the top left corner of the screen to open the Trimble Access menu. From there, you can run the other application.

To switch between applications:

- Tap the Trimble button in the task bar to access the menu of available applications and services currently running, including the Trimble Access menu. Select the application or service to switch to.
- On the TSC2/TSC3 controller, a short press of the Trimble button accesses the menu of available applications and services currently running, including the Trimble Access menu. Select the application or service to switch to.
- On the Trimble GeoXR controller, tap the Trimble button to access the menu of available applications and services currently running, including the Trimble Access menu and the *Windows Start Menu*. Alternatively, press and hold the camera button for two seconds and then select the application or service to switch to.
- Tap *Switch to* and then select the required function from the list. If the *Switch to* button is not on your current screen, press **CTRL W** to open the *Switch to* pop-up list.
- Press **CTRL TAB**. This is the keyboard shortcut to scroll through the current list of *Switch to* functions.
- Tap *Favourites* or press **CTRL A** to select a preconfigured favorite.
- On a TSC2/TSC3 controller, configure the [Left App] button and [Right App] button for the functions you want to run. This method opens an application even if that application is not running.

For more information, see [Trimble Access Buttons](#).

**Tip** - You can use this functionality to return to the main menu of the application you are currently running e.g. if you are running the *Define* option in Trimble Access Roads and you want to view the *Map*, tap the Trimble button and select Trimble Access Roads from the drop down list.

# Job Operations

## Jobs

A job can contain several different surveys. Select a job before you measure any points or make any calculations.

Jobs can be saved in your data folder, or in a [project folder](#) below your data folder.

Jobs that are defined in one Trimble Access application, for example, General Survey can be used in another application, for example, Roads.

To create a new job:

1. From the main menu, tap *Jobs / New job*.
2. Enter a name for the new job.
3. Tap  to create a new folder or select an existing folder.
4. Select a *Template* from the drop down list.
5. Tap the *Coord. sys.* button and choose a [coordinate system](#) for the job. Tap *Next*.
6. Configure the coordinate system settings required for the job and tap *Store*.
7. Tap the *Units* button to specify the units and various other settings for the job. Tap *Accept*.
8. Tap the *Linked files* button to select a linked file(s) for the job. Tap *Accept*.
9. Tap the *Active map* button to select an active map file(s) for the job. Tap *Accept*.
10. Tap the *Feature library* button to associate a feature library with the job. Tap *Accept*.
11. Tap the *Cogo settings* button to set the cogo settings for the job. Tap *Accept*.
12. Tap the *Additional settings* button to set additional settings for the job. Tap *Accept*.
13. Tap the *Media file* button to set the media settings for the job. Tap *Accept*.
14. Optionally, tap the *Page down* button to enter *Reference*, *Description* and *Operator* details, and any *Notes*.
15. Tap *Accept* to save the job.

A new job adopts the system settings from the last used job.

To open a job:

1. From the main menu, tap *Jobs / Open job*.
2. Tap  to expand a folder and display the files within the folder.
3. Tap the job name, or highlight the job name and tap *OK*.  
The job name appears in the title area of the main menu.

To delete a job:

1. From the main menu, tap *Jobs / Open job*.
2. Tap  to expand a folder and display the files within the folder.



If the job you want to delete is not highlighted, use the arrow keys to highlight it, or tap and hold it with the stylus.



**Note** - If you tap with the stylus without holding, the job that you highlight opens automatically.

3. Tap  to delete the file.
4. Tap *Yes* to confirm deletion, or *No* to cancel.

**Note** - When you delete a job, associated files (for example, \*.t02, \*.tsf \*.jpg) are not automatically deleted.

**Tip** - You can also use [Fn+ Del] on the TSC2/TSC3 controller or [Ctrl + Del] on the Trimble CU/Trimble Tablet to delete jobs from the *File / Open* dialog.

To copy a job:

1. From the main menu, tap *Jobs / Open job*.
2. Highlight the name of the job to be copied and tap .
3. Browse and highlight the folder to paste the file into and tap .

**Tip** - You can also use *Windows/File Explorer* to copy, rename, or delete a file.

**Note** - When you copy a job to another folder, associated files (for example, \*.t02, \*.tsf \*.jpg) are not automatically copied.

To create a new job with all the defaults (including Coordinate System settings) from another job:

1. From the main menu, tap *Jobs / Open job*.
2. Tap  to select the folder, if required.
3. Select and open the job that contains the settings to use as the defaults for the new job.

**Note** - To use the settings in the **current** job as defaults for the new job, omit steps 1 and 2. New jobs always use the settings from the previous job as defaults.

4. From the main menu, tap *Jobs / New job*.
5. Enter a name for the new job.
6. Tap the appropriate button to change job settings as required.
7. To save the job, tap *Accept*.

## Properties of Job

Use this menu to configure settings for the current job.

For more information, see:

[Coordinate system](#)

[Linked files](#)

[Active map files](#)

[Feature library](#)

[Cogo settings](#)

[Additional settings](#)

[Media file](#)

Each button displays the current settings. When you create a new job, settings from the previous job are used as the defaults. Tap a button to change the settings.

Tap *Accept* to save any changes.

## Review Job

To see the records stored in the job database:

1. From the main menu, tap *Jobs / Review job*.
2. Use the arrow keys, stylus, or softkeys to navigate the database.

### Tips

- ◆ To move to the end of the database quickly, highlight the first record and press the up arrow key.
  - ◆ To highlight a field without selecting it, tap and hold briefly with the stylus.
3. To see more information about an item, tap the record. Certain fields, for example, *Code* and *Antenna height*, can be edited.
    - ◆ Offset points that are stored as coordinates are not updated when you change an antenna or target height record in the database. In addition, a change in antenna height does not affect any postprocessed points that will be processed using the Trimble Business Center software. Verify the antenna or target height information when you transfer the data to the office computer or transfer postprocessed points directly from the receiver to the office software. When you change an antenna or target height record in the database, stakeout deltas, Cogo points, averaged points, calibrations, resections, and traverse results are not automatically updated. Re-observe staked out points, and re-calculate Cogo points, averaged points, calibrations, resections, and traverses.
    - ◆ To search for a particular item, tap *Search* and select an option.

**Tip** - To review features from the *Map* screen, select the required feature(s), tap and hold on the screen and choose *Review* from the shortcut menu.

To change the coordinate view display in *Review job*:

1. From the main menu, tap *Jobs / Review job*.
2. Use the arrow keys, stylus, or softkeys to navigate the database.
3. Do one of the following:
  - ◆ Tap + to expand the point tree list.

To change the coordinate display, tap one of the ordinates and then select the appropriate coordinate view from the list;  
Grid, Grid (local), WGS84, HA VA SD (raw), As Stored.

- ◆ Tap the point name to view details about the point.

To change the ordinate display:

- a. Tap *Options* and then select the appropriate *Coordinate view* from the list;  
As Stored, Local, Grid, Grid (local), ECEF (WGS84), Station and offset, Az VA SD, HA VA SD (raw), Az HD VD, HA HD VD, delta Grid.

If you selected *Station and offset*, select the entity type (Line, Arc, Alignment, Tunnel or Road) and the name of the entity the points position will be referenced from.

If you selected *Grid (local)*, select the *Transformation for grid (local) display* name. This transformation transforms the grid coordinates to Grid (local) coordinates using the selected transformation.

Unless the transformation selected here is the same as the input transformation, the Grid (local) coordinates shown will not match the original Grid (local) coordinates. To see the original Grid (local) coordinates, set the Coordinate view to *As Stored*.

*Transformation (as stored)* is displayed when reviewing Grid (local) and the *Coordinate view* is set to As Stored.

*Transformation (display)* is displayed when reviewing Grid (local) and the *Coordinate view* is set to Grid (local).

- b. Tap *Accept*.

To view a media file:

1. Highlight a media file record.

**Tip** - To highlight a field without selecting it, tap and hold briefly with the stylus.

2. Tap *Details*. The image appears.

## Inserting notes

To store a note in the database:

1. Highlight a record.
2. Tap *Note*. The *Note* screen that appears displays the date and time that the current record was created.

3. Enter the note and then tap *Accept*. The note is stored with the current record. In *Review job*, the note appears below the record with the note icon.

### **Editing target/antenna records using Review job**

Select *Review job* to edit existing antenna or target height records. These edits change the antenna or target height for all observations using that antenna or target height.

To edit a target/antenna record:

1. Tap the target/antenna record. The current target (conventional survey) or antenna (GNSS survey) details appear.
2. Enter the new details and then tap *Accept*.

The current record is updated with the new details, which apply to all subsequent observations using that record.

A note with a timestamp is attached to the record. This note documents the old details, including when the changes were made.

### **Editing target/antenna records using Point manager**

Use [Point manager](#) to easily change the target or antenna height of a single observation or any number of observations.

### **Editing codes using Review job**

If you have only a single code to edit, you can use *Review job*.

To edit a code:

1. From the main menu, tap *Jobs / Review job*.
2. Tap the observation record that contains the code you want to edit.
3. Change the code and then tap *Accept* to store the changes.

The Note stored with the observation is a record of the old code and the date and time it was modified.

### **Editing codes using Point Manager**

You can use *Point manager* to edit single or multiple codes.

When you edit multiple codes, the *Point manager* is easier to use than *Review job*.

For more information, see [Point manager](#).

### **Editing point names and point coordinates using Point Manager**

You can use [Point manager](#) to edit point names or point coordinates.

You cannot edit point names and point coordinates using *Review job*.

## Deleted points, lines, and arcs



A deleted point, line, or arc is not used in calculations, but it is still in the database. Deleting points, lines, or arcs does not make a job file smaller.

When you transfer a file that contains deleted points, the deleted points are not transferred to the office software. If you transfer a file using the Trimble Data Transfer utility, however, the deleted points are recorded in the Data Collector (.dc) file. They have a classification of Deleted.

Some points, such as continuous offset points and some intersection and offset points, are stored as vectors from a source point. If you delete a source point, any point stored as a vector from that point has null (?) coordinates when you review the database point record.

To delete a point, line, or arc in the General Survey database:

1. From the main menu, tap *Jobs / Review job*.
2. Highlight the point, line, or arc to be deleted and tap *Details*.
3. Tap *Delete*. For points, the search class changes to Deleted (normal), Deleted (control), Deleted (staked), Deleted (backsight), or Deleted (check), depending on the original search classification.
4. Tap *Accept*. The General Survey software records a note with the original point, line, or arc record, showing the time it was deleted.

When you delete a point, line, or arc, the point symbol changes. For example, for a topo point, the  symbol replaces the  symbol.

When you delete an observation that has been recorded during a [Station setup plus](#), a [Resection](#), or [Measure rounds](#) operation, the mean turned angle records and station or round residuals records will not be updated. Deleting an observation that has been used to compute an average does not automatically update the average. Use *COGO / Compute average* to recompute the average.

## Tips

To delete features from the *Map* screen:

You cannot delete points from a linked file.

Use Explorer to delete alignment files, road files, map files, or any other file type stored on the controller.

**Note** - You cannot delete points, lines or arcs from a linked map file (for example, a DXF or SHP file).

To restore a point, line, or arc in the General Survey database:

1. From the main menu, tap *Jobs / Review job*.
2. Tap the point, line, or arc record to be restored.
3. Tap *Undelete*.
4. Tap *Accept*.

# Point Manager

As an alternative to *Review job*, use the *Point manager* to manage your data.

You can easily review:

- Point coordinates
- Observations
- The **best point** and all duplicate points
- Target and antenna heights
- Codes and notes
- Descriptions
- Notes

You can easily edit:

- Target and antenna heights (single or **multiple**)
- **Point names**
- **Point coordinates**
- Codes (single or **multiple**)
- Descriptions (single or multiple)
- Notes

## Using Point manager

To open *Point manager*, select *Jobs / Point manager* from the main menu. The screen that appears shows a tabulated tree structure of all points and observations in the job database and linked files.

## Viewing the data

When there are duplicate points of the same name, the best point always appears first. All occurrences of points of the same name, including the best point, appear in a list below the best point. However, when the data is in the *Target height* view, all observations in the database appear in the order that they occur in the database.

To change the view of the data, select *Display*. For example, to view coordinates, set *Display* to Grid; to view or edit target heights, set *Display* to Target height.

**Note** - In *Point manager*, the *Target height* setting refers to both antenna height and target height.

To sort the data, tap the column heading.

To change the width of the column, or to hide the column, tap and drag the separator between headings.

To shrink an empty column double tap the separator to the right of the column.

Use the scroll bars to scroll horizontally or vertically through the data.

**Tip** - To freeze the Point name column, tap and hold the Point name column heading. To unfreeze the column, tap and hold the heading again.

To filter the displayed information using wildcard matching, tap . The screen that appears contains *Point name*, *Code*, and *Note* fields and, if enabled, two *Description* fields.

To filter the fields appropriately, use \* (for multiple characters) and ? (for a single character). The filters specified for the separate fields are processed together and only points that meet the criteria of all the filters will appear. Use \* in any field that you do not want to filter. Filtering is not case sensitive.

Filter examples:

Point name	Code	Descr. 1	Descr. 2	Note	Example results
*1*	*	*	*	*	1, 10, 2001, 1a
1*	*	*	*	*	1, 10, 1a
1?	*	*	*	*	10, 1a
*1*	Fence	*	*	*	All points with a name that contains a 1 and where code = Fence
*1*	*Fence*	*	*	*	All points with a name that contains a 1 and a code that contains Fence
1???	*	*	*	wrong*	All points with a name that starts with 1 and is 4 characters long and a note that starts with wrong
*	Tree	Aspen	25	*	All points where code = tree and Description 1 = Aspen and Description 2 = 25

To disable the filter, tap *Reset*, or set all fields to \*.

Filter settings are remembered, but are not applied if Point manger is closed. To reactivate the filter, tap  and then tap *Accept*.

**Note** - To see a complete list of the icons and their descriptions used in the General Survey software see the [filter table](#).

To view more information on a point do one of the following:

- To reveal all associated points and observations, tap + to expand the point tree list. Expand the subtree to view individual point information. These records can include the point coordinates, observations, antenna or target details, and quality control records.
- To open the same point form as seen in *Review job*, tap a point, or highlight a point and tap *Details*. This allows you to edit information such as the point code and attributes.

To change the format of the indented coordinates or the observations that appear when you expand the point tree, tap the coordinates or observations displayed, or highlight them and press the space key. In the list that appears, select the new data view.

This allows you to review the raw conventional observations (or WGS-84 observations) and the Grid coordinates at the same time.

### Using Grid (local) in the Point manager

You can use Point manager to view Grid (local) coordinates using the input transformation or a display transformation.

To do this:

1. From the main menu, tap *Jobs / Point manager*.
2. Tap *Display* and then select *Grid (local)*.
3. To select the Grid (local) transformation for coordinate display, or to create a transformation, select *Options*.
4. Do one of the following:
  - ◆ To view the original Grid (local) values, select *Display original grid local* and then tap *Accept*.
  - ◆ To create a new display transformation, select *Create new transformation*, tap *Next* and then complete the [required steps](#).
  - ◆ To select an existing display transformation, select *Select transformation*, select the display transformation from the list and then tap *Accept*.

### Notes

- ◆ The 'input' transformation transforms a point from the original entered Grid (local) coordinates to database grid coordinates.  
The 'display' transformation transforms a point, regardless of how it was stored, from the database grid coordinates to display computed Grid (local) coordinates.
- ◆ When viewing the original Grid (local), points not stored as Grid (local) appear as null North (local), East (local), and Elev (local).
- ◆ When you select a display transformation, all database grid points appear using the current display transformation. If the display transformation is different from the original transformation, the computed Grid (local) coordinates are different from the original entered Grid (local) coordinates.
- ◆ A point entered as a Grid (local) point is stored in its original format to the General Survey job as a Grid (local) point. Typically, the input transformation to transform the point to a database grid point is assigned at the time the point is entered, but the transformation can be created at a later stage and then [assigned](#) to the point(s) using Point manager.

To change the input transformation:

1. From the main menu, tap *Jobs / Point manager*.
2. Tap *Display* and then select *Grid (local)*.
3. Highlight the point(s) stored as Grid (local) whose input transformation you need to change.
4. Tap *Edit* and then select *Transformations*.



5. Select the new transformation and then tap *OK*.

The new transformation is now used to transform the Grid (local) to database grid.

If the current view showed the original Grid (local), changing the input transformation does not change the Grid (local) coordinates displayed.

If the current view showed a different display transformation, changing the input transformation also changes the Grid (local) coordinates displayed.

## Reviewing and editing antenna and target heights

**Note** - In *Point manager*, the *Target height* setting refers to conventional target heights and the GNSS antenna heights.

To change a target height record and update **all** observations using that target height record, edit the target height in [Review job](#).

To change an individual target height, or group of target heights, in *Point manager*:

1. From the main menu, tap *Jobs / Point manager*.
2. Tap *Display* and then select *Target height*. In the screen that appears, the point name, from point, target height, code, and note are listed in the order they exist in the database.

- To change the record order, tap the appropriate column heading.
- To filter the list, tap *Filter*, select the appropriate column and then enter the filter details.

**Tip** - If you enter a filter value of 2 for a point name, the system will show all points with 2 in their name, including 2, 1002, 2099, or 2day. To filter for a point name "2", select the Match whole word check box.

3. To select a target or multiple targets for editing, do one of the following:

- Tap the *Target* field.
- Use the arrow keys to highlight the record to edit and then tap *Edit*.
- To select multiple fields, press and hold *Ctrl* and then tap the required fields. Then tap *Edit*.
- To select a range of fields, tap the first required field, press and hold *Shift* and then tap the last required field. Then tap *Edit*.

4. In the *Target details* form enter the new *Target height* and/or *Prism constant*. To store the changes, tap *OK*.

When measuring to the bottom notch on a [Trimble prism base](#), tap the advanced pop-up arrow (  ) and then select *Bottom notch*.

Point manager now displays the corrected target details. In *Review job*, view the inserted target records with notes that record the old target details.

## Group editing Target heights (conventional) and Antenna heights (GNSS)

You can use the *Point manager* to edit details of antenna heights or target heights for multiple-selected points. This function is available when the *Display* softkey setting in the *Point manager* is set to *Target height*. Use the standard Windows selection methods of *Ctrl-click* and *Shift-click* to choose the points to apply the target or antenna height edits to.

- When you edit antenna heights, you can edit the measured heights and the measurement method.
- When you edit target heights, you can edit the measured target height value, the measurement method (when applicable), and the prism constant.
- When you select points to edit, you can include points with target heights and points with antenna heights. When you tap *Edit*, two dialogs appear - one to edit antenna heights and one to edit target heights.
- You do not need to select contiguous target and/or antenna heights to edit.
- You cannot edit a selection of antenna heights that includes more than one type of antenna. In this case, select and edit the points in separate groups, according to the type of antenna used.
- You can edit a selection of different targets. In such a case, the new target heights are applied to each of the different targets but the target numbers remain unchanged.
- Some conventional measurements use calculated (system) targets, which have a zero height and zero prism constants, for example, Dual-prism offset. You cannot edit the target heights for system targets.
- You can sort *Point manager* columns to help you find and select groups of target or antenna heights to edit. Tap the column heading to sort that column.
- The *Point manager* automatically inserts the appropriate target and antenna equipment records into the job database to ensure that the correct heights and measurement methods are assigned to each point.
- When you edit points, the *Point manager* automatically inserts notes into the job database to record what was edited, the original measurement data, and the time of the edit.

### **Editing Point Coordinates using Point manager**

You can use the *Point manager* to edit the coordinates of imported or keyed in points.

To edit the coordinates of a point:

1. From the main menu, tap *Jobs / Point manager*.
2. To select the record to edit, tap and hold the stylus on the record.
3. Tap *Edit* and then select *Coordinates*.
4. Edit the coordinates and then tap *OK* to save the changes.

You cannot edit the coordinates of:

- raw observations
- points in linked files
- a range of records at one time

A record of the changes made are saved to the *Note* record.

### **Renaming point names using Point manager**

You can use the *Point manager* to edit the names of points and observations.

To rename a point or observation:

1. From the main menu, tap *Jobs / Point manager*.
2. To select the record to edit, tap and hold the stylus on the record.
3. Tap *Edit* and then select *Point names*.
4. Edit the name and then tap *OK* to save the changes.

You cannot edit the name of

- points in linked files
- an observation to the current station if a survey is running
- a backsight observation

A record of the changes made are saved to the *Note* record.

### **Editing point names and point coordinates in a dynamic database**

The General Survey software uses a dynamic database. If you change the name or coordinates of a record, the positions of other records that rely on that record could change or disappear.

The rest of this section describes how changes to a base station position, station setup, or backsight position can affect other positions. In addition to these record types, changes to resections, lines, arcs, compute inverse records, and others may also affect other positions. For more details on specific records that may change, see the table below.

If you rename a point name that is used as a base in a GNSS survey, or as a station setup point in a conventional survey, this does not rename the point name that is referenced in the Base record or Station setup record. You cannot edit the point name referenced in the Base record or Station setup record in any way.

If you rename the base position or station setup position, and another record with the same name **does not** exist, then the positions of all records that are computed from that base position or station setup position cannot be computed, and those records will no longer be displayed in the map.

If you rename the base position or station setup position, and another record with the same name **does** exist, then the positions of all records that are computed from that base position or station setup position may change, as they will now be computed from the next best point with the same name.

If you edit the base position or station setup position, then the positions of all records that are computed from that base position or station setup position will change.

If you edit the azimuth in an a station setup with a keyed-in azimuth to the backsight, then the positions of all records that are computed from that station setup will change.

If you edit or rename the point record that is used as a backsight in a station setup with a computed azimuth to the backsight, then the positions of all records that are computed from that station setup may change.

If you select a range of records and change their name, all the selected records are renamed to the new name that you entered.

If you rename or edit the coordinates of points, all records that contain computed deltas to other points, for example as-staked, check, and backsight observations, are not updated.

In the following table, the \* symbol against a record type shows the dynamic database records that may change if the name or the coordinates of the record that was used to derive their position is modified.

<b>Record</b>	<b>Names</b>	<b>Coordinates</b>
Topo points (GNSS)	*	*
Rapid points	*	*
FastStatic points	*	*
Observed control points	*	*
F1 Topo points (Conv.)	*	*
F2 Topo points (Conv.)	*	*
Mean turned angle	*	*
As-staked points	*	*
Check points	*	*
Continuous points	*	*
Construction points	*	*
Laser points	*	*
Lines	*	*
Arcs	*	*
Compute inverse	*	*
Resection points	-	-
Adjusted points	-	-
Averaged points	-	-
Cogo points (computed) (see note below)	* 1	* 1
Intersection points	-	-
Offset points	-	-
Roads	-	-
Alignments	-	-
Tunnels	-	-
Calibration points	-	-
Compute area	-	-

1 - Cogo points can change if the point they are computed from is modified, but it depends on how the Cogo points were stored. If they were stored as a vector, for example Az HD VD and the base point is moved, then the Cogo point will also move.

## Adding or editing codes using Point manager

To enter a code or change an existing code, tap the *Code* field. Enter the code details, and the attributes, if required. Tap *Accept* to store the changes.

## Group editing codes using Point Manager

You can use the *Point manager* to edit code details for more than one point at a time.

1. Use the standard Windows selection methods; press **Ctrl** or **Shift** and tap the records for which you want to change the code.
2. Tap *Edit* and then select *Codes*.
3. Enter the new code and then tap *Enter*.

If the code has attributes, you are prompted to enter them.

The new codes are updated and displayed in the *Point manager*. A note with the old code value is stored for each modified record.

**Tip** - You can edit Descriptions in the same way.

## Adding or editing notes using Point manager

To enter a note or change an existing note, tap the *Note* field. Enter the note details and then tap *Accept* to store the changes.

# Map

The *Map* screen is a graphical representation of features from multiple sources:

- points, lines, and arcs from the current job database
- points, lines, and arcs from linked jobs and linked CSV files
- points, lines, arcs, polylines, and other map entities from [map files](#) (for example DXF and SHP files)
- alignments defined as .rxl files
- Trimble roads defined as .rxl files
- surfaces (TTM and LandXML files)
- images from georeferenced background image files. The following image file types and associated world files are supported:

**Note** - Only Bitmap, JPEG, and PNG files with an associated world file are available for selection.

### Tips

- ◆ If you have a Survey-Advanced license, you can export JPEG georeferenced image files from Trimble Business Center using [Image / Capture image]. Trimble Business Center enables large files to be reduced in size for improved performance on the controller.

- ◆ More memory is required to load a BMP file than is required to load a DXF file, and JPEG/PNG files are a compressed format file that requires more memory again when they are uncompressed and loaded into memory.

To compare the memory required to load a BMP file to a DXF file, multiple the BMP file size by four; so a 850 KB BMP file uses 3.4 MB of memory.

To compare the memory required to load a JPEG/PNG file to a DXF file, multiple the JPEG/PNG image height by width multiplied by four; for example if a 130 KB image is 1024 pixels wide by 768 pixels high ( $1024 \times 768 \times 4 = 3.14 \text{ MB}$ ), and so would require 3.14 MB of memory to load the file.

**Note** - Rotated images are not supported.

Use the following links to learn more about using the map:

- [Accessing the map](#)
- [Using the map softkeys and options](#)
  - ◆ [Zoom previous and zoom default](#)
  - ◆ [Widescreen mode](#)
  - ◆ [Point type filtering](#)
- [Selecting a feature in the map](#)
- [Deselecting a feature in the map](#)
- [Tap and hold shortcut menu](#)
  - ◆ [Current job](#)
  - ◆ [Linked file or Active map](#)
- [Autopan](#)
- [Linked files \(.csv .txt .job\)](#)
  - ◆ [Transferring linked files](#)
  - ◆ [Stakeout points from a linked file](#)
- [Active map](#)
  - ◆ [Layers and selectability](#)
  - ◆ [Colors in the map](#)
  - ◆ [Transferring and selecting maps](#)
  - ◆ [Notes on active maps, including supported map entity types](#)

**To access the *Map* screen:**

1. Tap *Map*. The current position of the GNSS antenna is displayed as a vertical/horizontal cross. The current orientation of a conventional instrument is shown by a dotted line extending from the instrument to the end of the screen. The location of the prism is shown as a cross when a distance is measured.
2. Tap *Map*. The current position of the GNSS antenna is displayed as a vertical/horizontal cross.
3. Use the [map softkeys](#) to navigate around the map.

If there is a point with the same name as another point in the database, the point with the higher search class is displayed. For more information about how the General Survey software uses search classes, see [Database search rules](#).

**Notes**

- Only grid coordinates are displayed. If you have not defined a projection, only points stored as grid coordinates appear.
- [Grid \(local\) coordinates](#) cannot be displayed if the input transformation was not defined.
- If the *Grid coords* field in the [Cogo settings](#) screen is set to Increase South-West or Increase South-East, the map display is rotated by 180° such that increasing south coordinates are displayed up the screen.





## Map Softkeys

Use the map softkeys to:

- navigate around the map
- change the map display options

Some softkeys can operate in an "active" mode. The effect of tapping on the map depends on the active softkey selected.

The functions are described in the following table:

Softkey	Function
	Tap this softkey to zoom in. Tap and hold the softkey to make it active. Tap the area of the map to zoom in on, or drag to create a box around the area of interest.
	Tap this softkey to zoom out. Tap and hold the softkey to make it active. Tap the area of the map to zoom out from.
	Tap this softkey to shift the center of the map area to another part of the map. Tap the softkey to make it active. Tap an area of the map to center on, or tap and drag the map area to where you want to pan.
	Tap this softkey to show all features on the screen. Tap the softkey to make it active.

Click the up arrow to access more softkey functions. The additional functions are described in the following table.

<i>Filter</i>	Shows a legend for the feature symbols and lets you choose which features are displayed.
<i>Pan to</i>	Displays the <i>Pan to point</i> screen. Enter a point name and scale value.
<i>Options</i>	Controls how name or code labels appear next to points in the map, including the label color.
	Controls the options to display road and alignment station values.
	Controls the option to display elevations in the map.
	Controls the options to display the points symbols and coded features for each point. If the <i>Display coded features</i> check box is selected, General Survey software draws lines between points that have feature codes with the <i>Feature type</i> configured to <i>Line</i> . When you create or edit a feature code, set the <i>Feature type</i> to <i>Line</i> and specify a <i>Line style</i> .
	Controls the option to display points from the stakeout list in the map. To do this, set the

	Display <i>stakeout list</i> points field to Yes.
	Controls the <a href="#">Automatic pan to your current position</a> option.
	Controls the option to automatically start a measurement when you press the measure key.
	Controls the option to hatch polygons in a background file.
	Controls the option to display the map in <a href="#">Widescreen mode</a> .
	Controls the option to display surfaces with a color gradient.
	Controls the option to display surface triangles.
	Enables a vertical offset to be specified that raises or lowers the surface when viewing from the map.
Layers	Controls the display of one or more active map files or layers.
	Controls the selectability of one or more active map files or layers.
	Controls the display and selectability of alignment files.
	Controls the display and selectability of Trimble road files.
	Controls the display and stake-ability of digital terrain models.

To explode polylines into individual line and arc segments, enable the *Explode polylines* check box in *Map / Layers / Options*.

### Zoom previous and Zoom default

In the map view, tap and hold the map softkey to display more navigation options:

- Zoom to the previous view
- Zoom to a default scale and location
- Set a default scale and location

### Widescreen mode

The map appears in widescreen mode across the entire width of the screen.

To access the status bar while the map is in widescreen mode, tap the arrow on the far right of the map. The status bar appears for approximately three seconds, after which time the map returns to widescreen.

To change the widescreen mode, do one of the following:

- Tap and hold in the map window and then select *Widescreen*
- Tap *Options* within the map screen and then select the *Widescreen* setting
- Press the '.' key on the controller

## Using the Map for Common Tasks

To select a feature from the map, do one of the following:



- Tap the required feature(s) from the map area. If there is more than one feature in the highlighted area, a list of features in this area appears. Select the features as required and then tap *OK* to return to the map.

**Tip** - When selecting a line, arc, or polyline to stakeout, tap near the end of the line, arc, or polyline that you want to designate as the start. Arrows are then drawn on the line, arc, or polyline to indicate the direction.

If the direction of the line, arc or polyline is incorrect, tap the line, arc or polyline to deselect it and then tap it at the correct end to reselect the direction required.

The direction of Alignments and Trimble roads is defined when they are created, and cannot be changed.

**Note** - The offset directions are not swapped when the line direction is reversed.

- Drag a box around the features you want to select.

When multiple features are selected in this way they are typically sorted in the order in which they are stored in the database. If the order of the entities in the selection is important, you should select them one by one.

To select a feature from a map file, the map file or layers must be made selectable.

**To deselect a feature from the map, do one of the following:**

- Tap the selected feature to deselect it. If there is more than one feature within the highlighted area, a list of features within this area appears. Deselect the features as required. Tap *OK* to return to the map.
- Tap and hold on the map and select *List selection* from the shortcut menu. A list of the selected features appears. Deselect the features as required.
- To clear the entire selection, double-tap off the selected features. Alternatively, tap and hold on the map and select *Clear selection* from the shortcut menu.

To carry out a task using the selected feature(s), do one of the following:

- Measure
  - ◆ If there are no features selected, tap *Measure* to measure the current position.

**Tip** - To change the code and/or descriptions when using *Measure* from the map, select a point in the map whose settings you want to be the default, tap and hold on the map briefly and then select *Set point details*.

Alternatively, if you want to change defaults values, but do not want to use the default from an existing point, make sure that there are no features selected before you set point details.
- Stakeout
  - ◆ If one or more features are selected, tap *Stakeout* to stake out the selected feature(s).  
If more than one point is selected, the points are added to the *Stake out points* list, from where you can select them for stakeout.

- ◆ If more than one line or arc is selected, the first item selected is the one used for stakeout.
- ◆ Double-tap a feature to stake out.  
If there is more than one feature within the highlighted area, a list of features within this area appears. Select the feature to stake out.

**Tip** - If two points are selected, tap and hold on the map and then select *Stake out line* to stake a line defined by the two selected points.

If the selection contains different feature types (points, lines, arcs), only features of the first type selected can be staked out from the map. To stake out other feature types, clear the selection then reselect the other features.

### Setting default point details

Tap and hold briefly on the map and then select *Set point details* from the menu.

Use *Set point details* to set the *Next point name*, *Code*, and *Description 1 and Description 2* (if enabled) that will be used as the defaults the next time you measure a point.

If you select a single point in the map when you select *Set point details*, the next available point name, and the code and descriptions of the selected point, become the defaults.

### Tap and hold shortcut menu in the map

Tap and hold on the map area to access a shortcut menu. The shortcut menu provides quick access to common tasks. The tasks depend on the number and type of features selected.

In the following table, the \* symbol against a task shows that you can access it through the shortcut menu for the feature at the top of that column.

Tap and hold menu options that are available for features in the current job:

Task	Feature					
	No Features	One point	Two points	Three or more points	Line	Arc
<a href="#">Review</a>	-	*	*	*	*	*
List section	-	*	*	*	*	*
Clear section	-	*	*	*	*	*
<a href="#">Widescreen</a>	*	*	*	*	*	*
Delete	-	*	*	*	*	*
<a href="#">Stake out point</a>	-	*	*	*	-	-
Stake out road	-	-	*	*	*	*
Measure calibration point	-	*	-	-	-	-
<a href="#">Navigate to point</a>	-	*	-	-	-	-
Turn to	*	*	-	-	-	-

Compute inverse	-	-	*	*	-	-
Key in point	*	-	-	-	-	-
Store road	-	-	*	*	*	*
Set point details	*	*	-	-	-	-
Check backsight	*	-	-	-	-	-
Check shot	-	*	-	-	-	-

Tap and hold menu options that are available for features in a linked file or active map file:

Task	Feature							
	One active map or linked file point	Two active map or linked file points	Three or more active map or linked file points	Active map line	Active map arc	Active map polyline	Alignment	Trimble road
Review	*	*	*	*	*	*	*	*
List section	*	*	*	*	*	*	*	*
Clear section	*	*	*	*	*	*	*	*
Widescreen	*	*	*	*	*	*	*	*
Delete	-	-	-	-	-	-	-	-
Stake out point	*	*	*	-	-	-	-	-
Stake out line	-	*	-	*	-	-	-	-
Stake out arc	-	-	-	-	*	-	-	-
Create/Stakeout alignment	-	*	*	*	*	*	*	*
Stake out alignment	-	*	*	*	*	*	*	*
Stake out road	-	*	*	*	*	*	*	*
Measure calibration point	*	-	-	-	-	-	-	-
Navigate to point	*	-	-	-	-	-	-	-
Turn to	*	-	-	-	-	-	-	-
Compute inverse	-	*	*	-	-	-	-	-
Area calculations	-	-	*	*	*	*	-	-
Subdivide a line	-	-	-	-	-	-	-	-
Subdivide an arc	-	-	-	-	-	-	-	-
Key in point	-	-	-	-	-	-	-	-
Key in line	-	*	-	-	-	-	-	-
Key in arc: 3 points	-	-	*	-	-	-	-	-
Key in arc: 2 points	-	-	*	-	-	-	-	-

+ center								
Store road	-	*	*	*	*	*	*	*
Set point details	*	-	-	-	-	-	-	-
Check backsight	*	-	-	-	-	-	-	-
Check shot	-	-	-	-	-	-	-	-

## Notes

- If you select a point with the same name as another point in the database, then select the *Review* or *Delete* option from the shortcut menu, a list of the duplicate points appears. Select the point you want to review or delete.
- Field fill-in. Enter feature names into fields by selecting from the map. Select the feature(s) from the map then select a survey function, such as Cogo or Stakeout. The selected feature(s) are automatically entered into the appropriate fields.
- Map selection list. The *Map selections option* is available on the right side of the feature name field when you have selected features from the map. Tap it to access the list of the selected features. Only features that are specific to the field are shown.
- You cannot use General Survey to delete points from linked files. Points from linked files do not appear in the *Review* screen list of deleteable points.
- Turn to is available in a conventional survey when a station setup has been completed, and no points are selected. When chosen it turns to the position where the stylus tapped on the screen.
- *Check backsight* and *Check shot* options from the map are available only in conventional surveys.

## Select points

From the tap and hold menu in the map, use the *Select* option to select points from the current job as well as points in files linked to the current job.

### Select from

Use the *Select from* menu to specify where to select the points from. Options are from the Current job, Current job and linked files, or Scan files.

Scan files list any scan files (\*.tsf) created in the current job using the Scanning option and the Trimble VX spatial station. You can select multiple scan files.

## Notes

- You can select scan files only when the current job has scan data associated with it.
- Use the *Select* softkey to edit the list of selected scan files; use the *Reset* softkey to deselect all scan files.

To select points from the current job or the current job and linked files, define your selection using any combination of the following fields: Point name or Point range, Code, Description 1, Description 2, Minimum elevation, and Maximum elevation.

## Notes

- Use the advanced pop-up arrow (  ) to toggle between the Point name field and the point range (From point, To point) fields.
- Use wildcards in these fields to make multiple selections. Use \* for multiple characters, and ? for a single character.
- If points are already selected, an *Append to current selection* check box appears on screen. Clear this option if you want to overwrite the current selection.
- Use the *Reset* softkey to clear all selection criteria from the fields.
- Any point selections made in the *Select* screen can be edited in the map view.

## Units

To configure the Units, tap *Jobs / Properties of job / Units* and change the fields as required.

**Tip** - In some fields (for example, *Azimuth*), you can enter a value in units other than the system units. The *Units* softkey appears in these fields. When you tap *Enter* to accept the field, the value is converted to the system units.

Use *Units* to configure the display of the following settings:

This setting	Specifies how the following values are displayed
Distance and grid coords	Distance and Northing/Easting coordinates
Height	Height and elevation
Distance display	The number of decimal places in all distance fields
Coordinate display	The number of decimal places in all Northing/Easting coordinate fields
Angles	Angles
Azimuth format	Azimuths
Lat / Long	Latitude and longitude
Temperature	Temperature
Pressure	Pressure
Coordinate order	Coordinates The order for the displayed grid coordinates can be set to: - North-East-Elev - East-North-Elev - Y-X-Z (equivalent to East-North-Elev - field prompts changed) - X-Y-Z (equivalent to North-East-Elev - field prompts changed) For the Y-X-Z and X-Y-Z options, the convention used defines that the Y axis is the East axis and the X axis is the North axis.
Station display (also known as Chainage in some	Station The station values can be displayed as either: - 1000.0 where the values are displayed as entered

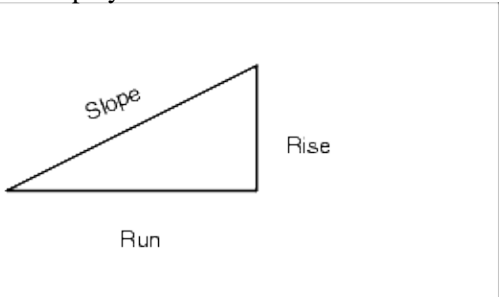
countries) This defines the distance along a line, arc, alignment, road or tunnel.	<ul style="list-style-type: none"> <li>- 10+00.0 where the + separates the hundreds from the remaining values</li> <li>- 1+000.0 where the + separates the thousands from the remaining values</li> <li>- <i>Station index</i></li> </ul> <p>The <i>Station index</i> display type uses an extra <i>Station index increment</i> field value as part of its definition. The station value is displayed as per the 10+00.0 option, but the value before the + is the station value divided by the <i>Station index increment</i>. The remainder is displayed after the +. For example if the <i>Station index increment</i> is set to 20, a station value of 42.0 m is displayed as 2 + 02.0 m. This display option is used in Brazil but may have application in other markets.</p>
Grade	<p>Grade</p> <p>The grade of a slope can be displayed as an angle, percent, or ratio.</p> <p>The ratio can be displayed as <i>Rise:Run</i> or <i>Run:Rise</i>.</p> 
Area	<p>Supported area units include:</p> <ul style="list-style-type: none"> <li>- Square meters</li> <li>- Square miles</li> <li>- Square international feet</li> <li>- Square US survey feet</li> <li>- Acres</li> <li>- Hectares</li> </ul>
Laser VA display	<p>Laser Vertical angles</p> <p>Can be vertical angles measured from the zenith, or inclinations measured from horizontal.</p>
Time format	Time

## Cogo Settings

To configure the Cogo settings, tap *Job / New job / Cogo settings* when creating a new job. For an existing job tap *Job / Properties of job / Cogo settings*.

Use *Cogo settings* to configure:

- [Distance display](#) (grid, ground, or ellipsoid)
- [Sea level \(ellipsoid\) correction](#)
- [Increasing grid coordinate direction](#)
- [South azimuth](#)
- [Neighborhood adjustment and weight exponent](#)
- [Magnetic declination](#)
- [Advanced Geodetic](#)

- [Averaging](#)

## Distance Display

The *Distances* field defines how distances are displayed and which distances are used for calculations in the General Survey software. Select one of the following options:

- Ground (the default setting)
- Ellipsoid
- Grid

The following diagram shows the options between points A and B.

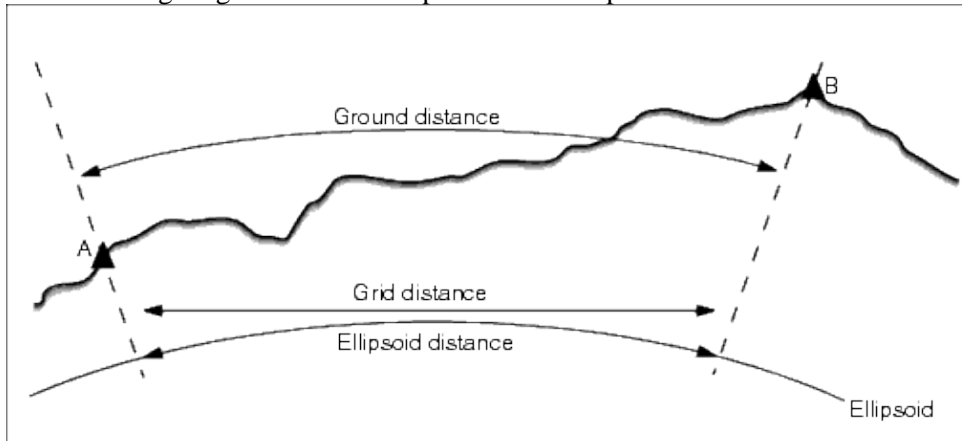

### Ground distance

A ground distance is the horizontal distance calculated between the two points at the mean elevation parallel to the chosen ellipsoid.

If an ellipsoid has been defined in the job and the *Distances* field is set to *Ground*, the distance is calculated parallel to that. If no ellipsoid has been defined, the WGS84 ellipsoid is used.

### Ellipsoid distance

If the *Distances* field is set to *Ellipsoid* then a correction is applied and all distances are calculated as if on the local ellipsoid, which usually approximates to sea level. If no ellipsoid has been specified, the WGS84 ellipsoid is used.

**Note** - If the coordinate system for a job is defined as *Scale factor only*, ellipsoid distances cannot be displayed.

### Grid distance

If the *Distances* field is set to *Grid*, the grid distance between two points is displayed. This is the simple trigonometrically distance between the two sets of two-dimensional coordinates. If the coordinate system for the job is defined as *Scale factor only*, and the *Distances* field is set to *Grid*, the

General Survey software displays ground distances multiplied by the scale factor.

**Note** - A grid distance between two measured GNSS points cannot be displayed unless you have specified a datum transformation and a projection, or performed a site calibration.

When you select *Scale factor only* in a conventional instrument only survey, grid and ground distances can be displayed.

### Curvature Correction

In the General Survey system, all ellipsoid and ground distances are parallel to the ellipsoid.

### Sea level (ellipsoid) correction

The *Sea level (ellipsoid) correction* check box enables you to choose whether or not the horizontal components of distances measured with a conventional total station should be corrected to their equivalent length on the ellipsoid.

In most case, select the *Sea level (ellipsoid) correction* check box to compute the correct geodetic grid coordinates from the total station observations.

However, if the local ellipsoid was inflated to provide computed ground coordinates, but the point heights were not changed to be in terms of the inflated ellipsoid, do not select sea level correction; for example, when using jobs with Minnesota county coordinate systems.

The sea level correction is carried out using the average height (not elevation) of the line above the local ellipsoid. If both ends of the line have null heights, the default height specified for the job is used to compute this correction.

The formula used for the computation is:

$$\text{Ellipsoid horizontal distance} = \text{HzDist} \times \text{Radius} / (\text{Radius} + \text{AvHt})$$

HzDist	Horizontal component of measured distance
Radius	Ellipsoid semi-major axis
AvHt	Average height above local ellipsoid of the measured line

### Notes

- In jobs where the coordinate system is configured to provide ground coordinates, the *Sea level (ellipsoid) correction* is always enabled and cannot be edited. This is because the sea level correction is already applied in the computation of the ground coordinates.
- In a Scale only job, there is no local ellipsoid available because this is not a geodetic projection. In this case, the correction computation defaults to using the semi-major axis of the WGS84 ellipsoid (6378137.0 m) as the radius value. The sea level correction in Scale only jobs also uses the point elevations because there are no ellipsoidal heights available.
- You cannot set a default height for Scale only jobs. This means that if the *Sea level (ellipsoid) correction* is enabled in a Scale only job, you must use 3D points, or null coordinates will be



computed because it is not possible to compute the sea level correction.

## Grid Coordinates

Use the *Grid coords* field to set the grid coordinates to increase in one of the following sets of directions:

- north and east
- south and west
- north and west
- south and east

The following diagram shows the effect of each setting.

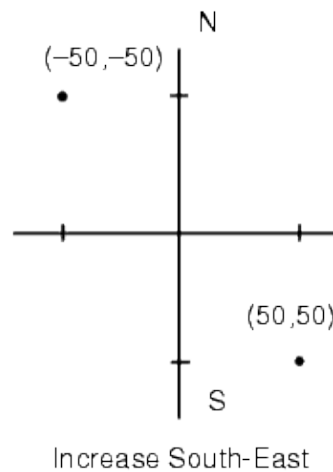
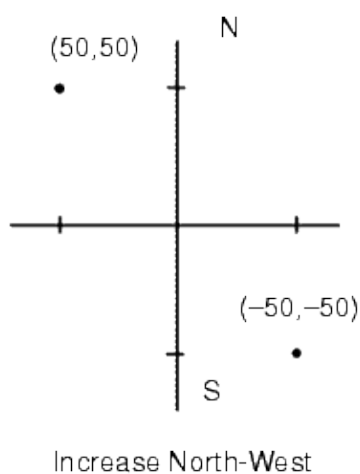
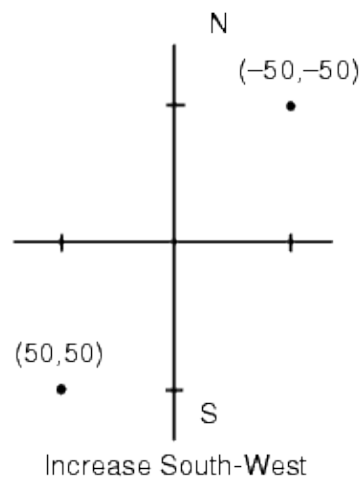
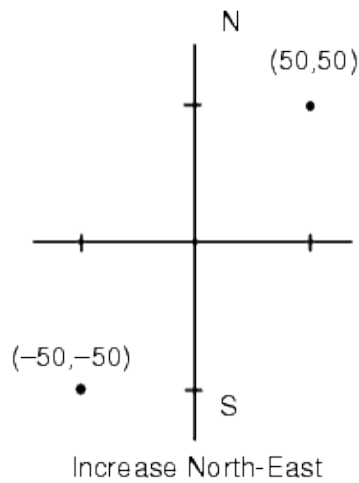

## Azimuth Display

The azimuth displayed and used by the General Survey software depends on the coordinate system that you defined for the current job:

- If you defined both a datum transformation and a projection, or if you selected *Scale factor only*, the grid azimuth is displayed.
- If you defined both a datum transformation and a projection, the grid azimuth is displayed.
- If you defined no datum transformation and/or no projection, the best available azimuth is displayed. A grid azimuth is the first choice, then a local ellipsoidal azimuth, then the WGS84 ellipsoid azimuth.
- If you are using a laser rangefinder, the magnetic azimuth is displayed.

If a south azimuth display is required, set the *South azimuth* field to *Yes*. All azimuths still increase clockwise. The following diagram shows the effect of setting the *South azimuth* fields to No or Yes.

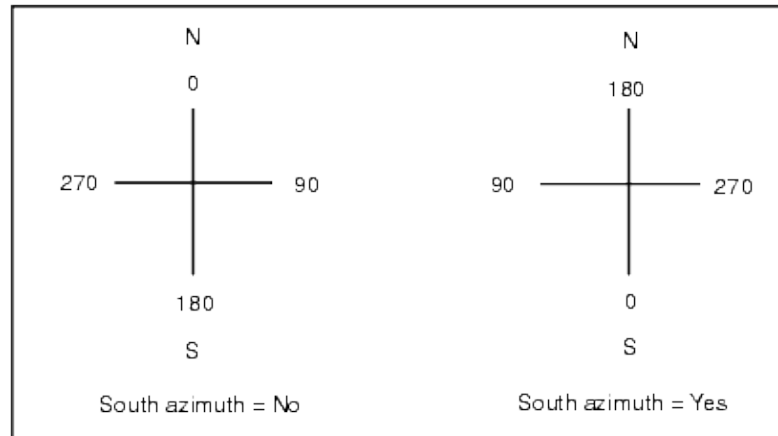

### Neighborhood adjustment

You can apply a *Neighborhood adjustment* to all conventional foresight observations made from a Station setup plus or Resection, and to all GPS observations made in a job that has a valid GPS site calibration. To apply Neighborhood adjustment, select the check box in *Properties of job / Cogo settings*.

Neighborhood adjustment uses the residuals from *Station setup plus*, *Resection* or *GNSS site calibration* to calculate delta grid values to apply to subsequent observations made during the survey. Each observation is adjusted according to its distance from each of the backsight points (for a conventional survey) or calibration points (for a GNSS survey). The following formula is used to calculate the weight to give the residuals of each backsight or calibration point:

$$p = 1/D^n \text{ where:}$$

- p is the weight of the backsight or calibration point
- D is the distance to the backsight or calibration point
- n is the weight exponent

A weighted average is then computed and the resulting delta values are applied to each new observation to get an adjusted grid position.

**Note** - A high value for the weight exponent results in low impact (weight) of distant backsight or calibration points.

For *Neighborhood adjustment* to be applied, the station setup or calibration must have at least 3 known points with 2D grid residuals. That is, if you perform a:

- Station setup plus, you must have HA VA SD observations to at least 2 backsight points, each with known 2D coordinates.
- Resection, you must have HA VA SD observations to at least 3 backsight points, each with known 2D coordinates.
- Calibration, you must have GNSS observations to at least 3 control points, each with known 2D coordinates.

## Notes

- Neighborhood adjustment will use a *GNSS site calibration* only if it has been observed in the current General Survey job. This is because a GNSS calibration that is part of the coordinate system in an uploaded job does not include the GNSS calibration residuals.
- For *Station setup plus*, the known station coordinate is included in the neighborhood adjustment calculation. In the calculation, the station coordinate is given grid residuals of zero.
- Neighborhood adjustment is a 2D-only adjustment. Any vertical residuals from station setup or calibration are not used in the neighborhood adjustment calculations.
- Neighborhood adjustment using GNSS site calibration residuals is applied to all WGS84 points in the job, not just GNSS observations.

**Warning** - Make sure that the backsight or calibration points are around the perimeter of the site. Do not survey outside the area enclosed by the backsight or calibration points (and for Station setup plus, the station point). The neighborhood adjustment is not valid beyond this perimeter.

## Magnetic Declination

Set the magnetic declination for the local area if magnetic bearings are being used in the General Survey software. You can use magnetic bearings if you choose the *Cogo / Compute* point using the Brng-dist from a point method.

The magnetic declination defines the relationship between magnetic north and grid north for the job. Enter a negative value if magnetic north is west of grid north. Enter a positive value if magnetic north is east of grid north. For example, if the compass needle points  $7^\circ$  to the east of grid north, the declination is  $+7^\circ$  or  $7^\circ\text{E}$ .

**Note** - Use the published declination values if available.

**Note** - If grid north in the job has been rotated away from true north due to the coordinate system definition (possibly via a GNSS calibration) then this must be allowed for in the magnetic declination specified.

## Advanced Geodetic

Select *Advanced Geodetic* to enable the following options:

- **Station setup scale factor**
- **Helmert transformation for Resection**
- **Local transformations**

- **SnakeGrid**

### **Averaging**

The *Averaging* field defines how duplicate points are averaged. Select one of the following options:

- Weighted
- Unweighted

**heading to sort the codes by that column.**

### **Additional Settings**

To configure the Additional settings, tap *Job / New job / Additional settings* when creating a new job. For an existing job tap *Job / Properties of job / Additional settings*.

# Define Roads

## Define

Tap *Define* to:

- key in, edit, and review a Trimble road
- to edit and review a LandXML file
- to define a road from a GENIO file

## Trimble roads

Use the *Define* option to:

- Define or edit a road
- Review a road

### Define or edit a road

1. Tap *Define*.
2. Tap *New* and enter a name for the road. (To edit an existing road, highlight the road name and tap *Edit*.)

**Tip** - Use the *Copy* option to copy an existing road definition with all its components into the current road.

3. Choose a component to define:

**Horizontal Alignment**

**Vertical Alignment**

**Templates**

**Template Positions**

**Superelevation and Widening**

**Station Equations**

**Additional Points**

4. Tap *Store* when all components have been defined.

## Tips

- Tap the *Report* softkey to generate a report of the offset, coordinates, elevation, and code for each position in the cross section for the selected stations. The values reported are for the resolved cross sections, that is, they include any superelevation and widening values that may have been applied, and any interpolation between different templates.
- Use *Rename* and *Delete* to rename or delete a road definition.
- Tap *Options* to specify a *Scale factor* for the road. This functionality is a requirement for the Ministry of Transportation Quebec, Canada but may have application elsewhere.

The specified scale factor scales a road horizontal alignment definition but retains the original station values. When defining the road, all values are entered and appear as unadjusted values. The scale factor is applied to the length/radius values defining each element/curve when computing the coordinates for the road definition. When surveying and reporting the road, the station values are not adjusted by the scale factor.

For a road defined by End coordinates or End points, Trimble recommends you do not change the scale factor after initial entry. Otherwise the scale factor rescales the alignment elements, and since the End coordinates / End point coordinates are not changed a change in station values must occur.

For a road defined by PI (Points of Intersection), Trimble recommends you do not change the scale factor after initial entry. Otherwise the scale factor rescales the curve components, and since the PI coordinates are not changed a change in station values must occur.

## Notes

- The Roads software treats all road distances, including station and offset values, as grid distances. The value in the *Distances* field (accessed from the Trimble Access menu by selecting *Settings / Units Cogo / Cogo Settings*) has no effect on the road definition or the way road distances are displayed.
- If a ground coordinate system is defined in the job, the grid coordinates are, in effect, also ground coordinates.
- Keyed in roads are saved to the current project folder as 'road name'.rxl. Roads are available for all jobs in the current project folder.
- To use a file saved to the current project folder in another project, use Windows Explorer to copy or move the file to the appropriate project folder.
- Alignment files are saved as .rxl files - the same format as Trimble roads.
- Alignments can be created or edited using Key in Trimble roads.
- Alignment files created from the map, or during Stakeout Alignment, contain a Horizontal alignment. If elevations exist, the files also contain a Vertical alignment.

## Review a road

1. Tap *Define*.
2. Highlight the road name to review and tap *Edit*.
3. Tap the *Review* softkey. A plan view of the road is displayed.

By default, the centerline for the first station is selected. To select another station or offset, do one of the following:

- ◆ Tap a position displayed on the screen.
- ◆ Tap and briefly hold on the screen to key in a station or offset or to select a station or offset from the list.
- ◆ If appropriate for your controller, press an up or down arrow on the controller keyboard to select another station, or press the left or right arrow to select another offset.

The centerline is shown as a red line. The red circles represent the positions defined by the station interval. The blue lines connect the cross sections. The rules for connection are described in the [example alignment](#). Values defining the selected position are displayed at the top of the screen.

To understand how cross sections are connected when consecutive horizontal elements are non tangential, see [Non tangent Horizontal Alignment Elements](#).

### Tips

- ◆ Tap and hold on a position to browse its northing, easting and elevation.
- ◆ Tap and hold on the pan softkey to make it active and then use the left, right, up, or down arrow keys on the controller to pan around the screen.

**Note** - The position of a side slope is indicative only and is shown by a dashed line.

4. To view the cross sections, tap the icon at the bottom right of the screen or press the **Tab** key.

By default, the last position selected in the plan view is selected. To view the cross section at other stations, do one of the following:

- ◆ Tap and briefly hold on the screen to key in a station or to select a station from the list.
- ◆ Depending on the controller model, do one of the following to select another station:
  - ◇ Press an up or down arrow on the controller keyboard.
  - ◇ Use the scroll bar to the right of the graphics window.

To select another offset, do one of the following:

- ◆ Tap the offset displayed on the screen.
- ◆ Tap and briefly hold on the screen to key in an offset or to select an offset from the list.
- ◆ If appropriate for your controller, press a left or right arrow on the controller keyboard to select another offset.

The centerline is shown as a red cross. The blue circles represent the positions defined by the template. Values defining the selected position are displayed at the top of the screen.

**Tip** - To see values that define a line, tap and hold on the line between two offsets.

## Horizontal Alignment

To add a horizontal alignment to a new road definition, select *Horizontal alignment*. You can enter the

alignment using one of the following methods:

- ◆ **Length / Coordinates**
- ◆ **End station**
- ◆ **PI**

**Tip** - You can also define the horizontal alignment (and vertical alignment if the linework has elevations), from features (points, lines, and arcs) in a file. To do this:

1. From the map, tap the *Layers* softkey, select the file and then make active the appropriate layer(s) that will be used to define the horizontal alignment.
2. Select the features. See *Using the map for common tasks* for further details.
3. From the tap and hold menu, select *Store road*.
4. Enter a name, start station, and station interval.
5. Tap *OK*.

From the *Define* menu, you can view the horizontal (and vertical alignment if applicable) for the resultant road, and add templates, superelevation and widening records, and station equations if required.

## Entry by Length / Coordinates

To add a horizontal alignment to a new road definition by entering the lengths of the elements or the end coordinates, select *Horizontal alignment* and then do the following:

1. Tap *New* to enter the first element that defines the alignment. The *Element* field is set to *Start point*. You cannot change this.
2. Enter the *Start station*.
3. In the *Method* field, choose one of the following options:
  - ◆ *Key in coordinates*
  - ◆ *Select point*

If you choose the *Key in coordinates* method, enter values in the *Start north* and *Start east* fields. If you choose the *Select point* method field, enter a value in the *Point name* field. The *Start north* and *Start east* fields will update with the values for the entered point.

**Tip** - To edit the *Start north* and *Start east* values when they have been derived from a point, change the method to *Key in coordinates*.

4. Enter the *Station interval*. To add the horizontal element, tap *Store*.
5. Tap *Options* to select the *Transition type*.

**Note** - For more information on supported transition types, see *Transitions*.

6. To enter the next horizontal element, tap *New*. In the *Entry Method* field, select *Length/Coordinates* and then tap *OK*.



7. Select the *Element* and *Method*, enter the required information and then tap *Store*. For details on supported elements and entry methods, see the following:

**Line elements**

**Arc elements**

**Entry transition/Exit transition elements**

8. When you have entered the last element, tap *Accept*.

**Tip** - To delete an element, highlight it and tap *Delete*. When you add an element, it appears below the previous element that you added. To insert it at a particular place in the list, highlight the element that you want it to follow. Tap *New* and enter details of the element.

9. Enter the other road components or tap *Store* to store the road definition.

**Line elements**

If you select *Line* in the *Element* field, the *Start station* field displays the start station value for the line that you are defining. You cannot edit this.

The following table shows the available methods and the fields that appear when you select each one.

Method	Procedure
Azimuth and length	In the <i>Azimuth</i> and <i>Length</i> fields, enter values that define the line. The <i>End north</i> and <i>End east</i> fields update with the values entered.
End coordinates	In the <i>End north</i> and <i>End east</i> fields, enter values that define the line. The <i>Azimuth</i> and <i>Length</i> fields update with the values entered.
Select end point	In the <i>Point name</i> field, enter a value. The <i>Azimuth</i> , <i>Length</i> , <i>End north</i> , and <i>End east</i> fields update with the values entered.

**Tip** - For a line defined by *Azimuth and length*, the *Azimuth* field shows the azimuth as calculated from the previous element. To edit the azimuth, select *Edit azimuth* from the pop-up menu in the *Azimuth* field. If the element is non tangential a solid red circle is shown at the start of the element. To reload the original azimuth, select *Restore tangency* from the pop-up menu.

**Arc elements**

If you select *Arc* in the *Element* field, the *Start station* field displays the start station value for the arc that you are defining. You cannot edit this.

The following table shows the available methods and the fields that appear when you select each one.

Method	Procedure
Radius and length	Specify arc direction. In the <i>Radius</i> and <i>Length</i> fields, enter values that define the arc.

Delta angle and radius	Specify arc direction. In the <i>Angle</i> and <i>Radius</i> fields, enter values that define the arc.
Deflection angle and length	Specify arc direction. In the <i>Angle</i> and <i>Length</i> fields, enter values that define the arc.
End coordinates	In the <i>End north</i> and <i>End east</i> fields, enter values that define the arc. The <i>Arc direction</i> , <i>Radius</i> , and <i>Length</i> fields update with the values entered.
Select end point	In the <i>Point name</i> field, enter a value that defines the arc. The <i>Arc direction</i> , <i>Radius</i> , <i>Length</i> , <i>End north</i> , and <i>End east</i> fields update with the values entered.
End coordinates and center point	In the <i>End north</i> , <i>End east</i> , <i>Center point north</i> , and <i>Center point east</i> fields, enter values that define the arc. If required select <i>Large arc</i> . The <i>Azimuth</i> , <i>Arc direction</i> , <i>Radius</i> , and <i>Length</i> fields update with the values entered.
Select end and center points	In the <i>End point name</i> and <i>Center point name</i> fields, enter values that define the arc. If required select <i>Large arc</i> . The <i>Azimuth</i> , <i>Arc direction</i> , <i>Radius</i> , <i>Length</i> , <i>End north</i> and <i>End east</i> fields update with the values entered.

**Tip** - For an arc defined by *Radius and length*, *Delta angle and radius* or *Deflection angle and length*, the *Azimuth* field shows the azimuth as calculated from the previous element. If the element is non tangential a solid red circle is shown at the start of the element. To reload the original azimuth, select *Restore tangency* from the pop-up menu.

### Entry transition/Exit transition elements

If you select *Entry transition/Exit transition* in the *Element* field, the *Start station* field displays the start station value for the entry transition or exit transition that you are defining. You cannot edit this.

Specify the arc direction. In the *Start radius*, *End radius* and *Length* fields, enter values that define the transition.

The *End North* and *End East* fields update to display the coordinates at the end of the element just added.

**Note** - For details on supported transition types see [Transitions](#).

### Tips

- The *Azimuth* field displays the azimuth as calculated from the previous element. To edit the azimuth, select *Edit azimuth* from the pop-up menu in the *Azimuth* field. If the element is non tangential a solid red circle is shown at the start of the element.
- If the transition type is NSW cubic parabola the computed *Transistion Xc* value is displayed. If the transition is between two arcs the *Transistion Xc* displayed is the value computed for the common tangent point with the smaller of the two arcs.

## Entry by End station

To add a horizontal alignment to a new road definition by entering end station values, select *Horizontal alignment* and then do the following:

1. Tap *New* to enter the first element that defines the alignment. The *Element* field is set to *Start point*. You cannot change this.
2. Enter the *Start station*.
3. In the *Method* field, choose one of the following options:
  - ◆ *Key in coordinates*
  - ◆ *Select point*

If you choose the *Key in coordinates* method, enter values in the *Start north* and *Start east* fields. If you choose the *Select point* method field, enter a value in the *Point name* field. The *Start north* and *Start east* fields will update with the values for the entered point.

**Tip** - To edit the *Start north* and *Start east* values when they have been derived from a point, change the method to *Key in coordinates*.

4. Enter the *Station interval*. To add the horizontal element, tap *Store*.
5. To enter the next horizontal element, tap *New*. In the *Entry Method* field select *End station* and then tap *OK*.
6. Tap *Options* to select the *Transition type*.

**Note** - For more information on supported transition types, see [Transitions](#).

7. Select the *Element* and *Method*, enter the required information and then tap *Store*. For details on supported elements and entry methods, see the following:

#### **Line elements**

#### **Arc elements**

#### **Entry transition/Exit transition elements**

8. When you have entered the last element, tap *Accept*.

**Tip** - To delete an element, highlight it and tap *Delete*. When you add an element, it appears below the previous element that you added. To insert it at a particular place in the list, highlight the element that you want it to follow. Tap *New* and enter details of the element.

9. Enter the other road components or tap *Store* to store the road definition.

**Tip** - Tap *Method* to change the entry method to *Length*.

### **Line elements**

If you select *Line* in the *Element* field, the *Start station* field displays the start station value for the line that you are defining. You cannot edit this.

In the *Azimuth* and *End station* fields, enter values that define the line. The *End North* and *End East* fields update to display the coordinates at the end of the element just added.

**Tip** - If this line is not the first line to be defined, the *Azimuth* field displays an azimuth calculated from the previous element. To edit the azimuth, select *Edit azimuth* from the pop-up menu in the *Azimuth* field. The icon preceding the element name is shown red if adjoining elements are non tangential.

### Arc elements

If you select *Arc* in the *Element* field, the *Start station* field displays the start station value for the arc that you are defining. You cannot edit this.

The following table shows the available methods and the fields that appear when you select each one.

Method	Procedure
Radius and end station	Specify arc direction. In the <i>Radius</i> and <i>End station</i> fields, enter values that define the arc.
Deflection angle and end station	Specify arc direction. In the <i>Angle</i> and <i>End station</i> fields, enter values that define the arc.

The *End North* and *End East* fields update to display the coordinates at the end of the element just added.

**Tip** - The *Azimuth* field displays the azimuth as calculated from the previous element. To edit the azimuth, select *Edit azimuth* from the pop-up menu in the *Azimuth* field. The icon preceding the element name is shown red if adjoining elements are non tangential or if adjoining elements defining a curve have different radii.

### Entry transition/Exit transition elements

If you select *Entry transition/Exit transition* in the *Element* field, the *Start station* field displays the start station value for the entry transition or exit transition that you are defining. You cannot edit this.

Specify arc direction. In the *Start radius*, *End radius* and *End station* fields, enter values that define the transition.

The *End North* and *End East* fields update to display the coordinates at the end of the element just added.

**Note** - For details on supported transition types see [Transitions](#).

### Tips

- The *Azimuth* field displays the azimuth as calculated from the previous element. To edit the azimuth, select *Edit azimuth* from the pop-up menu in the *Azimuth* field. The icon preceding the element name is shown red if adjoining elements are non tangential or if adjoining elements defining a curve have different radii.
- If the transition type is NSW cubic parabola the computed *Transistion Xc* value is displayed. If the transition is between two arcs the *Transistion Xc* displayed is the value computed for the common tangent point with the smaller of the two arcs.

## Entry by PI

To add a horizontal alignment to a new road definition by entering the points of intersection (PI), select *Horizontal alignment* and then do the following:

1. Tap *New* to enter the first element that defines the alignment. The *Element* field is set to *Start point*. You cannot change this.
2. Enter the *Start station*.
3. In the *Method* field, choose one of the following options:
  - ◆ *Key in coordinates*
  - ◆ *Select point*

If you choose the *Key in coordinates* method, enter values in the *Start north* and *Start east* fields. If you choose the *Select point* method field, enter a value in the *Point name* field. The *Start north* and *Start east* fields will update with the values for the entered point.

**Tip** - The selected entry method will be the default for subsequent elements. To change the entry method, select the *Method* option.

**Tip** - To edit the *Start north* and *Start east* values when they have been derived from a point, change the method to *Key in coordinates*.

4. Enter the *Station interval*. To add the horizontal element, tap *Store*.
5. To enter the next horizontal element tap *New*. In the *Entry method* field, select *PI* and then tap *OK*.
6. Tap *Options* to select the *Transition type*.

**Note** - For more information on supported transition types, see [Transitions](#).

7. Tap *New* and select the *Curve type*, enter the required information, and then tap *Store*. For details on supported curve types, see the following:

**None**

**Circular**

**Transition|Arc|Transition**

**Transition|Transition**

8. When you have entered the last element, tap *Accept*.

**Tip** - To delete an element, highlight it and tap *Delete*. When you add an element, it appears below the previous element that you added. To insert it at a particular place in the list, highlight the element that you want it to follow. Tap *New* and enter details of the element.

9. Enter the other road components or tap *Store* to store the road definition.

### Curve type: None

Define the PI and then select *None* in the *Curve type* field.

### Curve type: Circular

Define the PI and then select *Circular* in the *Curve type* field. Enter values defining the *Radius* and *Arc length* and then tap *Store* .

### Curve type: Transition|Arc|Transition

Define the PI and then select *Transition|Arc|Transition* in the *Curve type* field. Enter values defining the *Radius*, *Arc length*, *Transition length in*, and *Transition length out* and then tap *Store*.

**Note** - For details on supported transition types see [Transitions](#).

### Curve type: Transition|Transition

Define the PI and then select *Transition|Transition* in the *Curve type* field. Enter values defining the *Radius*, *Transition length in*, and *Transition length out* and then tap *Store*.

**Note** - For details on supported transition types see [Transitions](#).

## Transitions

The Roads software supports the following transition types.

Method	Length	End station	PI
Clothoid spiral	*	*	*
Egg-shaped clothoid spiral	*	*	-
Cubic spiral	*	*	*
Bloss spiral	*	*	*
Korean cubic parabola	*	*	*
NSW cubic parabola	*	*	-

### Clothoid spiral

The clothoid spiral is defined by the length of the spiral and the radius of the adjoining arc. The formulae for the 'x' and 'y' parameters in terms of these two values are as follows:

Parameter 'x':

$$x = l * [1 - \frac{l^4}{40R^2 L^2} + \frac{l^8}{3456R^4 L^4} - \dots]$$

Parameter 'y':

$$y = \frac{l^3}{6RL} \left[ 1 - \frac{l^4}{56R^2L^2} + \frac{l^8}{7040R^4L^4} - \dots \right]$$

### Egg-shaped clothoid spiral

By editing the *Start / End radius* for an *Entry / Exit transition* from *Infinite* to a required radius it is possible to define an egg shaped clothoid. To return to an infinite radius, select *Infinite* from the pop-up menu.

### Cubic spiral

The cubic spiral is defined by the length of the spiral and the radius of the adjoining arc. The formulae for the 'x' and 'y' parameters in terms of these two values are as follows:

Parameter 'x':

$$x = l * \left[ 1 - \frac{l^4}{40R^2L^2} + \frac{l^8}{3456R^4L^4} - \dots \right]$$

Parameter 'y':

$$y = \frac{l^3}{6RL}$$

### Bloss spiral

Parameter 'x':

$$x = l * \left[ 1 - \frac{l^6}{14R^2L^4} + \frac{l^7}{16R^2L^5} - \frac{l^8}{72R^2L^6} + \frac{l^{12}}{312R^4L^8} - \frac{l^{13}}{168R^4L^9} + \frac{l^{14}}{240R^4L^{10}} - \frac{l^{15}}{768R^4L^{11}} + \frac{l^{16}}{6528R^4L^{12}} \right]$$

Parameter 'y':

$$y = \left[ \frac{l^4}{4RL^2} - \frac{l^5}{10RL^3} - \frac{l^{10}}{60R^3L^6} + \frac{l^{11}}{44R^3L^7} - \frac{l^{12}}{96R^3L^8} + \frac{l^{13}}{624R^3L^9} \right]$$

### Korean cubic parabola

This cubic parabola is defined by the length of the parabola and the radius of the adjoining arc. The formulae for the 'x' and 'y' parameters in terms of these two values are as follows:

Parameter 'x':

$$x = l * [ 1 - \frac{l^4}{40R^2 L^2} ]$$

This formula is the same as for the 'x' parameter of the clothoid spiral, reduced to the first term of the series.

Parameter 'y':

$$y = \frac{x^3}{6RX}$$

### NSW cubic parabola

The NSW cubic parabola is a special parabola used for rail projects in New South Wales, Australia. It is defined by the length of the parabola and an 'm' value. Refer to [http://engineering.railcorp.nsw.gov.au/Civil\\_EngineeringStandards.asp](http://engineering.railcorp.nsw.gov.au/Civil_EngineeringStandards.asp) and see *Track Geometry Stability*, Reference number: *ESC 210* for the formulae for the 'x' and 'y' parameters in terms of these two values.

## Vertical Alignment

To add a vertical alignment to a new road definition, select *Vertical alignment*. You can enter the alignment using one of the following methods:

- **Vertical Points of Intersection**
- **Start and end points**

**Note** - The selected entry method applies to all elements defining the vertical alignment.

**Tip** - If you defined the horizontal alignment for your road from linework in a file, and the linework has elevations, these are used to define the vertical alignment as a series of *Point* elements. See [Horizontal alignment](#) for further details. The vertical alignment can be edited if required.

### Entry by Vertical Points of Intersection (VPI)

To add a vertical alignment to a new road definition by entering Vertical Points of Intersection (VPI), select *Vertical alignment* and then follow these steps:

1. To enter the first element that defines the alignment, tap *New*.
2. In the *Station* and *Elevation* fields, key in the values that define the first vertical point of intersection. The *Element* field is set to *Start point*. You cannot change this.
3. Tap *Store* to add the vertical element record.
4. Tap *New*. In the entry method field select *VPI* and then tap *Ok*.
5. Select the *Element*, enter the required information and then tap *Store*. For details on supported elements, see the following:



## Point elements

## Circular arc elements

## Symmetric parabola elements

## Asymmetric parabola elements

6. When you have entered the last element, tap *Accept*.

**Tip** - To delete an element, highlight it and tap *Delete*. When you add an element, it appears below the previous element that you added. To insert it at a particular place in the list, highlight the element that you want it to follow. Tap *New* and enter details of the element.

7. Enter the other road components or tap *Store* to store the road definition.

### Point elements

If you select *Point* in the *Element* field, use the *Station* and *Elevation* fields to key in values that define the VPI. The *Slope in* field updates to display the calculated slope value. The *Slope out* field updates when the next element is added.

**Note** - A vertical alignment defined by VPIs must end with a point.

### Circular arc elements

If you select *Circular arc* in the *Element* field, use the *Station* and *Elevation* fields to key in values that define the VPI. Enter the radius of the circular arc in the *Radius* field. The *Slope in* field updates to display the calculated slope value. The *Length*, *K factor* and *Slope out* fields update when the next element is added.

### Symmetric parabola elements

If you select *Sym parabola* in the *Element* field, use the *Station* and *Elevation* fields to key in values that define the VPI and a length for the parabola. The *Slope in* field updates to display the calculated slope value. The *K factor* and *Slope out* fields update when the next element is added.

### Asymmetric parabola elements

If you select *Asymmetric parabola* in the *Element* field, use the *Station* and *Elevation* fields to key in values that define the VPI. Enter the In and Out lengths of the parabola. The *Slope in* field updates to display the calculated slope value. The *K factor* and *Slope out* fields update when the next element is added.

**Note** - When you edit an element, only the selected element is updated. All adjoining elements remain unchanged.

**Tip** - To confirm the entry, use the *Slope in*, *Slope out*, *K factor* and *Sag / Summit* values.

## Entry by start and end points

To add a vertical alignment to a new road definition by entering Start and end points, select *Vertical alignment* and then follow these steps:

1. To enter the first element that defines the alignment, tap *New*.
2. In the *Station* and *Elevation* fields, key in the values that define the first vertical point of intersection. The *Element* field is set to *Start point*. You cannot change this.
3. Tap *Store* to add the vertical element record.
4. Tap *New*. In the entry method field select *Start and End points* and then tap *Ok*.
5. Select the *Element*, enter the required information and then tap *Store*. For details on supported elements, see the following:

### Point elements

### Circular arc elements

### Symmetric parabola elements

6. When you have entered the last element, tap *Accept*.

**Tip** - To delete an element, highlight it and tap *Delete*. When you add an element, it appears below the previous element that you added. To insert it at a particular place in the list, highlight the element that you want it to follow. Tap *New* and enter details of the element.

7. Enter the other road components or tap *Store* to store the road definition.

### Point elements

If you select *Point* in the *Element* field, use the *Station* and *Elevation* fields to key in values that define the start point. The *Slope in* field updates to display the calculated slope value. The *Slope out* field updates when the next element is added.

### Circular arc elements

If you select *Circular arc* in the *Element* field, use the *Start station*, *Start elevation*, *End station*, *End elevation*, and *Radius* fields to key in values that define the circular arc. The *Length*, *Slope in*, and *Slope out* fields update to display the calculated values.

### Symmetric parabola elements

If you select *Sym parabola* in the *Element* field, use the *Start station*, *Start elevation*, *End station*, *End elevation*, and *K factor* fields to key in values that define the parabola. The *Length*, *Slope in*, and *Slope out* fields update to display the calculated values.

**Note** - When you edit an element, only the selected element is updated. All adjoining elements remain unchanged.

**Tip** - To confirm the entry, use the *Slope in*, *Slope out*, *K factor* and *Sag / Summit* values.

## Templates

To define a template for a new road definition, select *Templates* and then do the following:

1. Tap *New*, enter a template name and then tap *OK*.  
To edit an existing template, highlight the template name, tap *Edit*, select the element to edit from the graphical template view and then tap *Edit* again.

### Tips

- ◆ Use the *Copy from* option to copy an existing template definition, either from the current road or from a previously defined road, into the current template.
  - ◆ To create a template library, define a road that only contains templates.
3. Tap *New* to enter the first element defining the template.
  4. Select an option from the *Element* field and enter the required information. For more information, see the appropriate section below.

### Cross slope and offset

### Delta elevation and offset

### Side slope

5. To add the template element, tap *Store*. The element is added, and appears in the graphical template view. When you add an element, it appears after the previous element that you added. To insert it at a particular place, highlight the element in the graphical view that you want it to follow. Tap *New* and then enter details for the element.

**Tip** - To delete an element, highlight it and tap *Delete*.

6. To enter more elements that define this template, tap *New*.
6. When you have entered the last element, tap *Accept*.
7. To save the template, tap *Accept*.

**Tip** - To rename a template, highlight it and then tap *Rename*. To delete a template, tap *Delete*.

### Cross slope and offset

If you selected *Cross slope and Offset* in the *Element* field:

1. In the *Cross slope* and *Offset* fields, enter the values that define the element.

**Tip** - To change the way a cross slope value is expressed, tap *Options* and change the *Grade* field as

required.

2. Enter a value in the *Code* field (this step is optional).

**Tip** - The annotation entered in the *Code* field is assigned to the end of the element and is displayed during stakeout.

3. Select the *Apply superelevation* and *Apply widening* check boxes as required.

**Note** - When the pivot position is set to *Pivot left* or *Pivot right*, the algebraic difference in cross slope between the first template element with superelevation applied and the superelevation value is used to calculate the superelevation for all other template elements with superelevation applied.

4. Select *Apply super rollover* and then specify a *Max value* to limit shoulder rollover. For more information, see [Understanding superelevation rollover](#).

### Delta elevation and offset

If you selected *Delta elevation and Offset* in the *Element* field:

1. In the *Delta elevation* and *Offset* fields, enter the values that define the element.
2. Enter a value in the *Code* field (this step is optional).

**Tip** - The annotation entered in the *Code* field is assigned to the end of the element and is displayed during stakeout.

3. Select the *Apply superelevation* and *Apply widening* check boxes as required.

**Note** - When the pivot position is set to *Pivot left* or *Pivot right*, the algebraic difference in cross slope between the first template element with superelevation applied and the superelevation value is used to calculate the superelevation for all other template elements with superelevation applied.

4. Select *Apply super rollover* and then specify a *Max value* to limit shoulder rollover. For more information, see [Understanding superelevation rollover](#).

### Side slope

If you selected *Side Slope* in the *Element* field:

1. In the *Cut slope (1)*, *Fill slope (2)*, and *Cut ditch width (3)* fields, enter the values that define the element.

**Note** - Cut and fill slopes are expressed as positive values.

**Tip** - To define a side slope with only a cut or fill slope, leave the other slope value field as '?'.  
  
The following diagram shows the side slope.

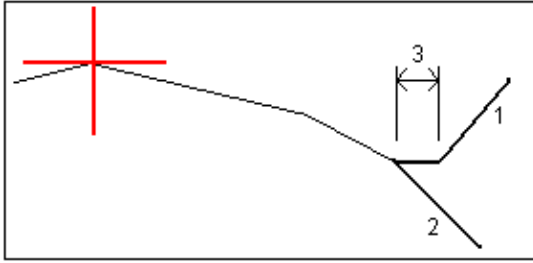

2. Enter a value in the *Code* field (this step is optional).

**Tip** - The annotation entered in the *Code* field is assigned to the end of the element and is displayed during stakeout.

## Template Positions

Define the position of templates in a road definition by specifying the station at which the Roads software starts to apply each template. A template is applied at the start station and template element values are then interpolated linearly (applied on a pro rata basis) from that point to the station where the next template is applied.

To define the template positions:

1. Select *Template positions*.
2. Tap *New*.
3. In the *Start station* field, specify the start station for the template(s).
4. Select the templates to apply. The options in the drop-down list for the *Left template* and *Right template* fields are as follows:
  - ◆ <None> - no template is assigned. Use this option to create a gap in the road definition.
  - ◆ <Interpolate> - the template for this station is interpolated from the previous and next templates in the road definition.
  - ◆ Templates - defined using the *Key in / Templates* option.
6. Tap *Store* to apply the templates.
7. Tap *New* to enter more templates at other positions.
8. When all template positions are entered tap *Accept*.

**Tip** - To delete a highlighted entry, tap *Delete*.

9. Enter the other road components or tap *Store* to store the road definition.

**Note** - To specify the interpolation method used to calculate cross sections between template positions tap the [Options](#) softkey and tap *Elevation* or *Cross slope*.

For more information, see the [example alignment](#) with the associated table. That topic describes how to use the template assignments, including the templates "None" and "Interpolate", to achieve the required road definition.

## Example Alignment

The following discussion explains how positioning of templates and use of system templates can be used to control a Trimble road definition. See the plan in the following figure.

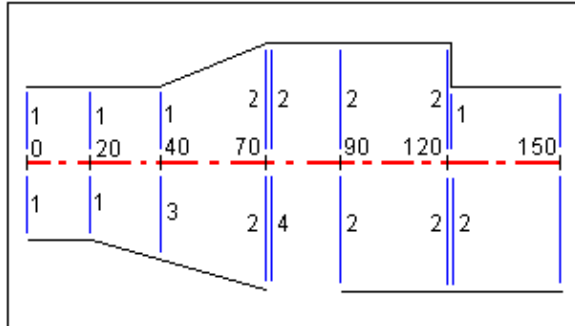

### Right side of the road

On the right side, template 1 is assigned to stations 0 and 20. The road transitions from template 1 at station 20 to template 2 at station 70. Because a template must be assigned at station 40 on the left side, the system template <Interpolate> 3 must be assigned to the right side of the road to maintain correct interpolation. To correctly represent the gap between stations 70 and 90, the system template <None> 4 is assigned at a nominal distance after station 70 (5 mm). To complete the right side of the road, template 2 is assigned to stations 90, 120, and 120.005.

### Left side of the road

On the left side, template 1 is assigned to stations 0, 20, and 40. The road transitions from template 1 at station 40 to template 2 at station 70. To correctly represent the design, template 1 is assigned a nominal distance after station 120 (5 mm).

Assign the templates at the specified start stations as shown in the following table:

Start station	Left templates	Right templates
0.000	Template 1	Template 1
20.000	Template 1	Template 1
40.000	Template 1	<Interpolate> 3
70.000	Template 2	Template 2
70.005	Template 2	<None> 4
90.000	Template 2	Template 2
120.000	Template 2	Template 2
120.005	Template 1	Template 2

### Template Interpolation

The two methods used to calculate cross sections between template positions are:

- by elevation
- by cross slope

### Interpolation by elevation

See the following figure where the template at station 100 includes a first element with an end elevation of 10.0. The next template is assigned at station 400 and has a first element with an end elevation of 7.0. The cross section for stations 200 and 300 are interpolated as shown to provide even grading of elevation from station 100 to 400.

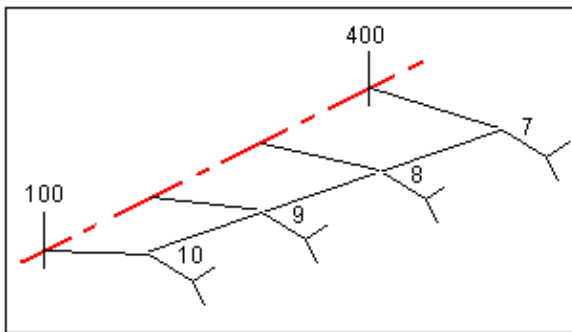

### Interpolation by cross slope

See the following figure where the template at station 100 includes a first element with a crossfall of -2%. The next template is assigned at station 400 and has a first element with a crossfall of -5%. The cross section for stations 200 and 300 are interpolated as shown to provide even grading of cross slope from station 100 to 400.

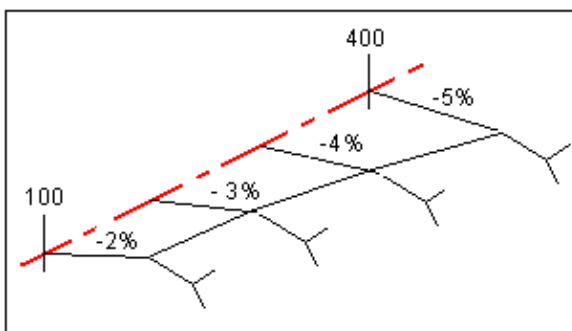

### Interpolating between templates that have a different number of design elements

For templates with an unequal number of design line elements, the template with the least elements has, in effect, zero length elements added before the side slope element. The interpolation is then performed given an equal number of elements exist. See the figure below, where a zero length element 3 has automatically been inserted.

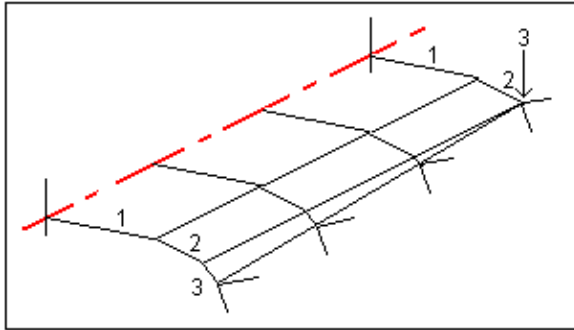

By adding zero length template elements, you can further control the interpolation process to best represent the road design.

### Notes

- If the design requires a gap in its definition use the None templates.
- No interpolation occurs between a null and a valid template.
- Templates are interpolated after superelevation and widening have been applied.

### Interpolation of side slopes

If consecutive templates contain side slopes of differing values intermediate stations have side slopes interpolated based on the slope value as a percentage.

For example, if the side slope value at station 600 is 50% (1:2) and at station 800 it is 16.67% (1:6) the side slope value at station 700 will be  $50\% + 16.7\% / 2 = 33.33\%$  (1:3).

## Non Tangent Horizontal Alignment Elements

The following diagram illustrates how cross sections connect when consecutive horizontal alignment elements are non tangential.

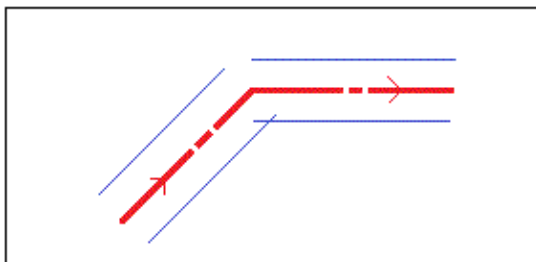

To understand how this affects the reported values when staking by *Position on road* and your current position is near the point of non tangency, see [Position relative to a Trimble or LandXML road](#).



To understand how this affects the reported values when staking by *Nearest offset* and your current position is near the point of non tangency, see [Nearest offset](#).

## Superelevation and Widening

Define where superelevation and widening values are applied in a road definition by specifying the station at which the Roads software starts to apply them. Superelevation and widening values are applied at the start station, and values are then interpolated linearly (applied on a pro rata basis) from that point to the station where the next superelevation and widening values are applied.

To add superelevation and widening values to a new road definition:

1. Select *Superelevation & widening* and tap *New*.
2. In the *Start station* field, specify the station where the superelevation and widening starts.
3. In the *Left super* and *Right super* fields, enter superelevation values for the left and right sides of the horizontal alignment.

**Tip** - To change the way a superelevation value is expressed, tap *Options* and change the *Grade* field as required.

4. In the *Pivot* field, specify the position about which the template rotates. The options are *Pivot left*, *Pivot crown*, and *Pivot right*.

### Notes

- ◆ For *Pivot left* the pivot position is the maximum offset, left of the centerline, of the last template element with superelevation applied.
- ◆ For *Pivot crown* the pivot position is at the centerline.
- ◆ For *Pivot right* the pivot position is the maximum offset, right of the centerline, of the last template element with superelevation applied.
- ◆ When the pivot position is set to *Pivot left* or *Pivot right*, the algebraic difference in cross slope between the first template element with superelevation applied and the superelevation value is used to calculate the superelevation for all other template elements with superelevation applied.

5. In the *Left widening* field, enter the widening value to be applied.

This value is applied to each element in the template that has the *Widening* check box selected.

6. Do the same for the *Right widening* field. Tap *Store* to add these superelevation and widening values to the road definition.

**Note** - Widening is expressed as a positive value.

7. To enter more superelevation and widening records tap *New*.
8. After entering the last superelevation and widening record, tap *Accept*.

**Tip** - To delete an entry, highlight it and tap *Delete*.

9. Enter the other road components, or tap *Store* to store the road definition.

## Understanding superelevation rollover

Superelevation rollover is explained below.

### Outside of curve (high side)

As shown below, the superelevation rollover value is the maximum algebraic difference in cross slope (3) between a template element (1) where that element (typically, the carriageway or travel lane) is adjusted by superelevation and the next template element (2) where that element is not adjusted by superelevation (typically, the shoulder). If the station being staked includes superelevation that results in the difference in cross slope exceeding the specified maximum, the slope of the shoulder is adjusted so that the algebraic difference in slope is not exceeded.

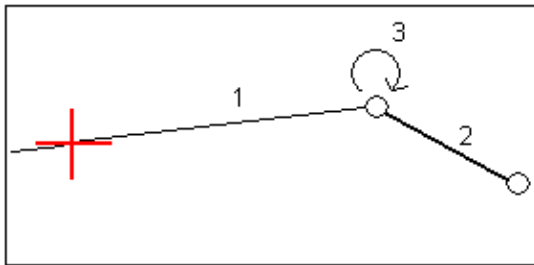

### Inside of curve (low side)

For the inside of a superelevated curve, the shoulder (2) uses its design value unless that value is less than the slope value of the superelevated carriageway (1). In that case, the superelevated value for the carriageway is used for the shoulder. This behavior happens only if you specified a maximum superelevation rollover value.

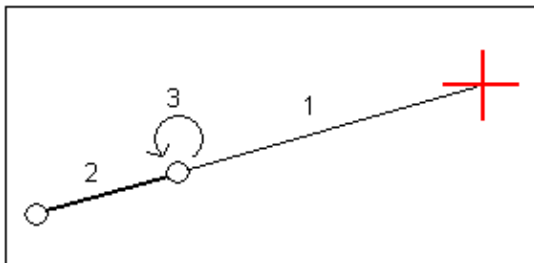

## Station equations

Use *Station equations* to define the station values for an alignment.

To define an equation:

1. Select *Station equations*.
2. Tap *New*.
3. In the *Back station* field, enter a station value.
4. In the *Ahead station* field, enter a station value. The *True station* value will be calculated.
5. Tap *Store*.

The values entered in the *Back station* and *Ahead station* fields are shown: The zone is indicated by a number after the colon in each field. The calculated *Progression*, indicating whether the station value increases or decreases after the station equation, is also shown.

**Note** - The zone up to the first station equation is zone 1.

**Tip** - To change the progression for the last station equation, tap *Edit*.

6. To add further equations, tap *New*. To delete an equation, tap *Delete*. To accept the entered equations, tap *Accept*.

## Additional Points

Use *Additional points* to define design features like key positions for a drainage system or road cross sections. The points are defined relative to a horizontal alignment, and optionally a vertical alignment. The points can be keyed in or imported.

To key in a new point, tap *New* and fill out the fields as required. Each additional point must include a *Station* and an *Offset* value. The *Elevation* and *Code* fields are optional.

To import points, tap *Import*. You can import points from a file only if you have not already keyed in additional points.

**Note** - Each position in the file must be defined by a station and offset and, optionally, an elevation and code, in that order. See the following:

1+000.000, 0.250, 25.345, ,  
1+000.000, 2.000, 25.345, Median  
1+000.000, 3.000, , Lane  
1+000.000, 7.000, 25.294, Shoulder

## LandXML roads

To review and edit a LandXML road:

1. Tap *Define*.
2. Highlight the LandXML file and then tap *Edit*.
3. Select the *Road name* and *Surface* to edit and then tap *Edit*.

## Tips

- ◆ Side slopes for roads in a LandXML file are not supported. However, if the last element in a template represents a side slope, select the *Set last template element as side slope* option to convert this element to a side slope. The slope value and direction of the element will be used to define the side slope.
- ◆ If the elevations defining the cross sections are absolute, select the *Absolute design cross-section elevations* option to ensure the templates are resolved correctly.
- ◆ When selecting a LandXML file from 12d Model where the transition type is *cubic* you will be prompted to select the applicable cubic type. This is because the cubic type is not identifiable in the file. Choose from:
  - ◇ Cubic spiral
  - ◇ NSW cubic parabola

4. Choose one of the following component to edit:

**Horizontal alignment**

**Vertical alignment**

**Templates**

**Template Positions**

**Superelevation and Widening**

**Station Equations**

5. If you edit the road definition, tap *Store* to save the edited road as a Trimble road (road name.rxl).
6. Tap the *Review* softkey to see plan and cross section views of the road.  
Tap the *Report* softkey to generate a report of the road.

For more information about reviewing and reporting, see [Trimble roads](#).

## Notes

- The Roads software treats all road distances, including station and offset values, as grid distances. The value in the *Distances* field (accessed from the Trimble Access menu *Settings / Units Cogo / Cogo Settings*) has no effect on the road definition or the way road distances are displayed.
- If a ground coordinate system is defined in the job, the grid coordinates are, in effect, also ground coordinates.
- When you review a road in a LandXML file, the road is temporarily converted to a Trimble road providing all the review options available for a Trimble road.
- When you edit a road in a LandXML file, the road is temporarily converted to a Trimble road, providing all the editing options available for a Trimble road. When you save the edits, the road is stored as a Trimble road (road name.rxl). The original LandXML file remains in the current project folder.

- The Roads software supports LandXML roads where the horizontal alignment is defined by elements or Points of Intersection (PI's). However LandXML files with curves defined by spiral-arc-connectingSpiral-arc-spiral are not supported.

**Tip** - Trimble recommends that large LandXML files are saved as a Trimble road to improve performance at stakeout.

## GENIO roads

To define a new road from a GENIO file:

1. Tap *Define*.
2. Select a GENIO file from the list. Tap *Edit*.
3. Tap *New*, and enter a road name and then tap *OK*.

(To edit or review an existing road, highlight the road name and then tap *Edit*.)

4. Tap strings to select them. Alternatively, drag a box outline to select multiple strings. Selected master strings are shown as solid red circles. Selected sub strings are shown as solid blue circles. Tap a selected string to deselect it.
5. To clear your current selection or to undo your last selection, tap and hold on the screen and then select the appropriate option from the pop-up menu.
6. To select strings from a list of string names, tap and hold on the screen and then select *List selection* from the pop-up menu. Tap the string names you want to select. Selected strings appear in the list with a check mark next to them. To clear your current selection, tap *Clear*.

### Tips

- ◆ Tap the up arrow to access the *map softkeys* to navigate around the graphical view.
  - ◆ Tap and hold on the pan softkey to make it active and then use the left, right, up, or down arrow keys on the controller to pan around the screen.
7. To confirm your selection, tap the icon at the bottom right of the screen to view the first cross section. To view the cross section at other stations, do one of the following:
    - ◆ Press an up or down arrow on the controller keyboard.
    - ◆ Tap and briefly hold on the screen and then key in a station or select a station from the list.
  8. By default, the master string is selected. To select other strings, do one of the following:
    - ◆ Tap the string displayed on the screen.
    - ◆ Press a left or right arrow on the controller keyboard.
    - ◆ Tap and briefly hold on the screen and then key in a string name or select a string from the list.

The current station, string name, and its offset and elevation appear at the top of the screen.

**Tip** - To see the values that define a line, tap and briefly hold on the line between two strings.

9. Tap *Accept* to save your selection.
10. Tap *Accept* to store the road.

## Notes

- A road can include only one master string (6D). If the GENIO file does not include a 6D string but does include a 12D string, then the Roads software will generate a 6D string with the same geometry as the 12D string and positions every 5 meters / feet.
- Because the station values for 3D and 5D strings are defined relative to the selected 6D string, select strings that obviously define a road.
- Where available, Trimble recommends that you include the 12D string that is coincident with the selected master string in the road. 12D strings include the geometry for the vertical alignment that enables the Roads software to correctly interpolate elevations between positions along the master string.
- If a road includes a 12D string or if there is a 12D string in the GENIO file that is related to the 6D string in the road the station values in the 12D string that define the horizontal alignment are suffixed with their appropriate acronyms. For example, PC for the start of a curve.
- Unselected master and geometry strings appear as open red circles. Unselected sub strings (3D and 5D) appear as open dark gray circles.
- Tap and hold on a string to browse the string name. For a master (6D) string the station range is also displayed.
- To define a new 3D string, tap and hold on the screen and then select *New string* from the pop-up menu. This option is not available until you have selected a master (6D) string.
- To exclude the master string, tap and hold on the screen in the plan or cross section view and select *Exclude master at stakeout* from the pop-up menu.
- A GENIO file consists of a number of strings. When you define a road you select the appropriate strings from the GENIO file. The road name and the names of the selected strings are saved as a comment to the end of the GENIO file.

## New string

Use this function to [define](#) a new string, [edit](#) a string you have defined, or [delete](#) a string.

### Defining a new string

1. Select a GENIO file and define a new road or edit an existing road.
2. Tap and hold in the graphics screen and then select *New string* from the pop-up menu.
3. Enter a string name.
4. Select the string that the new string will be derived from.
5. Select a string derivation method and then enter values that define the new string.

The following figure illustrates the *Offset and calculated slope* method where the *Derived from* string (1), the *Offset* value (2) and the *Calculated from* string (3) define a new string (4) on the slope between the *Derived from* and *Calculated from* strings.

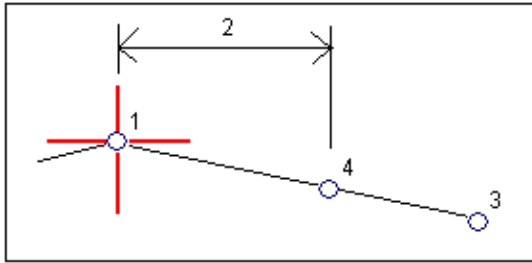

6. Tap *Accept*.

## Notes

- When you define a new road, you must select a master (6D) string before the *New string* menu option is available.
- New strings are created as 3D strings.
- You cannot define a new string relative to a 5D string.
- When you define a new string by the *Offset and calculated slope* method, the new string is defined only where the station values for the *Derived from* and *Calculated from* strings match.
- New strings are colored teal.

## Editing a new string

1. Select a GENIO file and then select the road containing the string to edit.
2. Tap and hold in the graphics screen and select *Edit string* from the pop-up menu.
3. Select the string to edit. You can edit only those strings that were defined using the *New* string function and that are derived from a string that belongs to the current road.
4. Edit the details as required.
5. Tap *Accept*.

## Deleting a string

1. Select a GENIO file and then select the road containing the string to delete.
2. Tap and hold in the graphics screen and then select *Delete string* from the pop-up menu.
3. Select the string to delete. You can only delete strings that have been defined using the *New* string function.
4. Tap *OK*.

## Tips

- ◆ Tap the up arrow to access the *map softkeys* to navigate around the graphical view.
- ◆ Tap and hold on the pan softkey to make it active and then use the left, right, up, or down arrow keys on the controller to pan around the screen.

## Exclude Master String at Stakeout

If the Master string (6D) has a vertical geometry that is unrelated to the road design, you can exclude this string.

To do this:

- When defining a GENIO road, tap and hold on the screen and from the pop-up menu select *Exclude master at stakeout*.

The master string will still be part of the road and will be used to calculate the station values at stakeout.

At stakeout, the master string will appear greyed out in the plan graphical selection screens and does not appear in the cross section view. The master string will also be unavailable from the string selection list.

**Tip** - To ensure that the master string is available at stakeout, clear *Exclude master at stakeout*.

## Exporting GENIO files from 12d Model

To export a road as a GENIO file from 12d Model:

1. Start 12d Model and select a project.
2. Select *File I/O / Data output - GENIO*.
3. From the *Write GENIO File for* dialog, select the alignment string as the data to write.
4. Enter a file name.
5. Set the *Alignment dimension* field to 6D.
6. Select the *77 Format* check box.
7. Write the file but do not select *Finish*.
8. Select the remaining strings that define the road as the data to write.
9. Retain the file name used to write the alignment string.
10. Set the *Alignment dimension* field to 3D.
11. Write the file and then select *Yes* to append to the end of the existing file.
12. Select *Finish*.

**Tip** - Use the filter option to aid string selection.



# Survey Roads

## Stakeout - Roads

Tap *Survey* to stakeout and measure:

[Trimble roads](#)

[LandXML roads](#)

[GENIO roads](#)

See also:

- [Survey Settings](#)
- [Precise Elevation](#)
- [Roads stakeout details](#)
- [Stakeout relative to a DTM](#)
- [Using the graphical display](#)

### Survey Settings

When you start a survey, you are prompted to select a survey style. To learn more about survey styles and related connection settings, tap *Settings* from the Trimble Access menu and then tap:

- *Survey styles* to edit or define a survey style. Survey Styles define the parameters for configuring and communicating with your instruments, and for measuring and storing points.
- *Connect / GNSS contacts* to create or configure a cellular modem dial profile.
- *Connect / Auto connect* to configure your auto connect options.
- *Connect / Radio settings* to configure the Radio channel and Network ID on a Trimble VX Spatial Station or Trimble S Series total station. These settings are used with a conventional instrument in robotic mode.
- *Connect / Bluetooth* to establish a connection to other devices using Bluetooth wireless technology.

### Road Stakeout Precise Elevation

Precise elevation enables you to combine the elevation from a robotic total station with the horizontal position from a GNSS survey. Typically, the robotic total station is set up in a remote location with good visibility and safe from machinery. The elevation is determined by one or more *Station elevation* measurements to point(s) with a known elevation. You can set up the robotic total station on a known control point, but this is not required.

Precise elevation is available for staking out Trimble, GENIO, and LandXML roads during an integrated survey.

To configure an integrated survey style:

1. From the Trimble Access menu, tap *Settings / Survey styles* and then tap *New*.
2. Enter the *Style name*, set the *Style type* to *Integrated Surveying* and then tap *Accept*.
3. Select the *Conventional* and *GNSS* styles you want to reference for the integrated style and then tap *Accept*.
4. Enter the *Prism to antenna offset*.
5. To stake a road using Precise elevation, where the GNSS horizontal position is combined with the elevation from a conventional setup, enable *Precise elevation*.
6. Tap *Accept* and then tap *Store* to save the changes.

**Note** - When the *IS rover* option is enabled, the only way to change the GNSS antenna height in an integrated survey is to use Target 1 and enter the height to the **prism**. The GNSS antenna height is computed automatically using the *Prism to antenna offset* configured in the IS style.

### To perform a Station elevation setup, and then start the RTK survey:

1. From Roads, select *Survey / <integrated style name> / Station elevation*.
2. Set the **corrections** associated with the instrument.

If the *Corrections* form does not appear, tap *Options* from the *Station setup* screen to set the corrections.

To make the *Corrections* form appear on startup, select the *Show corrections on startup* option.

3. Tap *Accept*.
4. If required, enter the Instrument point name, Code, and Instrument height. If you are set up in an arbitrary location, accept the default point name and 0.000 instrument height.
5. Tap *Accept*.
6. Enter the point name, code, and target details for the point with the known elevation. Tap *Measure*. Once the measurement is stored, the *Point residuals* appear.

**Tip** - You can use the pop-up arrow to select a point from a list, or key in a point. The point needs only a name and an elevation - horizontal coordinates are not required.

6. From the *Point residuals* screen, tap one of the following softkeys:
  - ◆ + *Point*, to observe additional known points
  - ◆ *Details*, to view or edit point details
  - ◆ *Use*, to enable or disable a point
7. To view the station elevation result, tap *Results* in the *Point residuals* screen. To accept the result, tap *Store*.

The RTK survey starts. Once the RTK survey has initialized, you can begin to stake out using Precise elevation.

During a Precise elevation road stakeout survey, the horizontal navigation is provided by the RTK survey, and the elevation is provided by the robotic survey. When a measurement is initiated, both a GNSS measurement and a conventional measurement are started at the same time. Separate GNSS and conventional measurements are stored in the job database, along with a grid coordinate that combines the results.

**Note** - If the robotic total station cannot measure to the target, the cut\fill and vertical distance values appear as "?".

### Road stakeout details that apply to all three road formats

The Roads software treats all road distances, including station and offset values, as grid distances. The value in the *Distances* field of *Jobs / Properties of job / Units* has no effect on the road definition or the way road distances are displayed.

If a ground coordinate system is defined in either the Trimble Geomatics or Roads software, then the grid coordinates are, in effect, also ground coordinates.

### Stakeout relative to a DTM

You can stake a road relative to a DTM. When you do this the horizontal navigation is relative to the road but the displayed cut/fill delta value is to a selected DTM.

Staking relative to a DTM is available for Trimble, GENIO, and LandXML roads.

To stake relative to a DTM:

1. From Roads, select *Survey* and then select the road to stake.
2. Tap the *Options* softkey and from the *Display* group box select the DTM and then select the *Display cut/fill to DTM* option. Optionally specify a *V.Offset to the DTM*.

### Notes

- If the road includes templates the displayed cut/fill delta will be to the selected DTM, not the templates.
- The heading for the displayed cut/fill value will change to *V.dist DTM*.
- When staking relative to a DTM you cannot view the cross sections.

### Using the Graphical Display

The graphical display helps you to navigate to a position on the road. The display orientation assumes you are moving forwards at all times. The display varies depending on whether you are performing a [Conventional](#) or [GNSS](#) survey.

**Tip** - If navigating with TSC3 or Trimble Slate Controller you can use the internal compass to aid navigation. See [Compass](#) for further details.

### Conventional

To use the graphical display in a conventional survey:

If you are using the *Direction and distance* mode:

1. Hold the display screen in front of you as you walk forwards in the direction that the arrow is pointing. The arrow points in the direction of the point.

2. When you get to within 3 meters (10 feet) of the point, the arrow disappears, and the in/out and left/right directions appear, with the instrument as a reference point. Follow the instructions below to navigate in this mode.

If you are using the *In/out and left/right* mode:

1. The first display shows which way the instrument should be turned, the angle that the instrument should display and the distance from the last point staked to the point currently being staked.
2. Turn the instrument (two outline arrows will appear when it is on line), and direct the rod person on line.

If you are using a servo instrument, and the *Servo auto turn* field in the survey style is set to *HA & VA*, or *HA only* the instrument automatically turns to the point.

If you are working robotically, or when the *Servo auto turn* field in the survey style is set to *Off*, the instrument does not turn automatically. To turn the instrument to the angle indicated on the screen, tap *Turn*.

3. If the instrument is not in *TRK* mode, tap *Measure* to take a distance measurement.
4. The display shows how far the person holding the rod should move towards or away from the instrument.
5. Direct the person holding the rod, and take another distance measurement.
6. Repeat steps 2 - 5 until the point has been located (when four outline arrows are displayed), then mark the point.
7. If a measurement to the target is within the angular and distance tolerances, tap *Store* at any time to accept the current measurement.

If the instrument is in *TRK* mode and you require a higher precision distance measurement, tap *Measure* to take an *STD* measurement and then tap *Store* to accept that measurement.

To discard the *STD* measurement and return the instrument to *TRK* mode, tap *Esc*.

If you are operating a robotic instrument remotely from the target:

- ◆ the instrument automatically tracks the prism as it moves
- ◆ the instrument continuously updates the graphical display
- ◆ the graphical display is reversed and the arrows are shown from the target (prism) to the instrument

## GNSS

When you use the graphical display in a GNSS survey to navigate to a position on the road, the screen first shows a large navigation arrow when you are some distance away from the point and then automatically changes to a bull's-eye target as you move in closer.

- The arrow assumes that you are moving forward at all times.
- The bull's eye target does not assume that you are moving forward.

To use the graphical display in a GNSS survey:

1. Hold the display screen in front of you as you walk forwards in the direction that the arrow is pointing. The arrow points in the direction of the point that you intend to measure.
2. When you get to within 10 feet (3 meters) of the point, the arrow disappears and a bull's-eye target appears.

When the bull's-eye target is displayed, do not change your orientation. Keep facing in the same direction and only move forwards, backwards, left or right.

3. Continue moving forwards until the cross, representing your current position, covers the bull's-eye target, representing the point. Mark the point.

### Stakeout display orientation

Select the display orientation when defining your survey style or, when in a survey, from the *Options* softkey. The options are:

- Direction of travel - the screen will orientate so that the top of the screen points in the direction of travel.
- North - the screen will orientate so that the north arrow points up the screen.
- Reference azimuth - the screen will orientate to the azimuth of the road.

### Go Forward/Go Backward directions

As shown in the diagram below, the values in the *Go Forward/Go Backward* (1) and *Go Right/Go Left* (2) fields in the graphical display are relative to the cross-section of the point that you are staking out. They are **not** relative to the current direction of travel, or to the current station value. The direction of increasing station values is shown by (3).

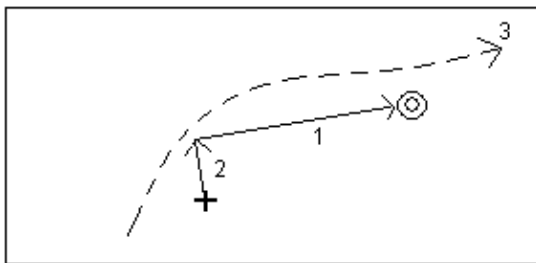

## Staking Trimble Roads

To stake out a Trimble road:

1. Tap *Survey*, select a survey style and start a survey.
2. Select a Trimble road and tap *OK*.

### Tips

- ◆ To add files from another folder to the list, tap *Add*, navigate to the required folder and then select the file(s) to add.
- ◆ If you are warned that the road is incomplete or invalid return to *Define* and select the road. Open each component defining the road and tap *Accept*. This will validate the component and report any errors in the definition. Use the editing functionality to resolve the error.

The Roads software enables you to stake out a Trimble road by the following methods:

**Station and offset**

**Position on road**

**Nearest offset**

**Side slope from alignment**

**Position from file**

**Note** - You must specify a coordinate system before you can stake out roads with the Roads software.

**Warning** - Do not stake out points and then change the coordinate system or perform a calibration. If you do, these points will be inconsistent with the new coordinate system and any points computed or staked out after the change.

**Tip** - During a conventional survey, you can use the tap and hold menu in the map to quickly measure a check point. If there are no points selected, *Check backsight* is available; if one point is selected *Check shot* is available.

Alternatively, to measure a check shot from any screen, press [CTRL + K] on the controller.

## Stakeout - Station and offset

To stake out a Trimble road or a road from a LandXML file by station and offset:

1. In the *Stake* field, select *Station and offset*.
2. Enter a value in the *Antenna/Target height* field and make sure that the *Measured to* field is set correctly.
3. To select the point to be staked out, enter values in the *Station* and *Offset* fields.

The *Code* field displays the code of the offset to be staked out. The Roads software uses the code from the template definition for the selected offset. When the offset is 0.000 m, the code defaults to CL.

4. Enter the *Station interval* or accept the default value set when the road was defined.
5. To edit the design elevation, tap the arrow. To reload an edited elevation, select *Reload original elevation* from the pop-up menu in the *Design elevation* field.

**Note** - If the position that you select for stakeout has no elevation, the *Design elevation* field becomes available. Enter an elevation into this field.

6. If required, enter values in the *Construction offsets* fields.
7. Tap *Stakeout* and then use either the plan or *cross section* graphical display to navigate to the point.

The graphical display shows the:

- ◆ Station
- ◆ Code / offset
- ◆ Elevation of your current position (shown in blue)
- ◆ Design elevation of the selected position (shown in red if edited)
- ◆ Center line (shown as a red line)
- ◆ Other linework (shown as blue lines)
- ◆ Positions that have not been staked (shown as open circles)
- ◆ Positions that have been staked (shown as solid circles)

The base of the screen displays the navigation deltas.

### Tips

- ◆ To select the delta display, tap the arrow to the left of the navigation deltas.
- ◆ Tap *Options* for further delta display options.
- ◆ To view the *cross section* of your current position, tap the icon at the bottom right of the graphics window. Alternatively, press the [Tab] key on the controller to switch between the plan view and the cross section view.
- ◆ To define a cross slope, see *Cross slope*.
- ◆ To access the status bar while the graphics window is in widescreen mode, tap the arrow on the far right of the screen. The status bar appears for approximately three seconds, after which time the window returns to widescreen.
- ◆ To change the widescreen mode tap and hold in the graphics window and then select *Widescreen*.

8. When the point is within tolerance, measure the point.

### Tips

- ◆ When using a GNSS receiver with an in-built tilt sensor, you can:
  - ◇ tap *eBubble* to display an electronic bubble
  - ◇ configure the survey style to prompt a warning when the pole is outside a specified *Tilt tolerance*
- ◆ Tap *Options* to configure the quality control, precision, and *tilt settings*.

### Notes

- If you are staking to a *catch point* with construction offsets, navigate to the catch point and then tap *Apply* to add the construction offsets. You are prompted to apply the offsets from your current position. If you are not on the catch position, select *No*, navigate to the catch position and then tap *Apply* again.

If you want to store the catch position and the construction offset, see [Construction offsets](#).

- To edit the side slope value or to select a new hinge offset, tap and hold in the graphics window and then select *Edit Side Slope*. See [Editing Side Slopes](#) for further details.
- A side slope is shown in red if edited.
- If a road consists of a horizontal alignment only, you can stake it out in only two dimensions.
- The horizontal and vertical alignments of a road may not start and end at the same station values. When they start and end at different station values, you can only stake out points in three dimensions if their stations lie within the horizontal alignment.

See also:

### [Catch point](#)

### [Catch point staked deltas](#)

### Selecting a station

You can select a station by one of the following methods:

- Select from the list in the *Station* field pop-up menu.
- Key in a value.
- Tap *Sta+* or *Sta-* to select the next/previous station.

The stations in the list are controlled by the [Station interval](#) and by the [Available stations](#) option in the Stakeout options dialog. The following table lists the abbreviations that the Roads software uses.

Abbrev.	Meaning	Abbrev.	Meaning
CS	Curve to transition	SS	Transition to transition
PC	Point of curvature (Tangent to curve)	ST	Transition to tangent
PI	Point of intersection	TS	Tangent to transition
PT	Point of tangent (Curve to tangent)	VCE	Vertical curve end
RE	Road end	VCS	Vertical curve start
RS	Road start	VPI	Vertical point of intersection
SC	Transition to curve	XS	Regular sections
Hi	Vertical curve high point	Lo	Vertical curve low point
SES	Superelevation start	SEM	Superelevation maximum
SEE	Superelevation end	WS	Widening start
WM	Widening maximum	WE	Widening end
T	Template assignment	STEQ	Station equation

### Selecting an offset

You can select an offset by one of the following methods:



- In the *Offset* field, select *List* from the pop-up menu and then select from the list.
- Key in a value.

Enter a negative value for an offset to the left of the centerline; enter a positive value for an offset to the right. If you enter a value greater than the maximum offset in the template, a message appears to warn you that the offset is outside the range. The software asks if you want to use the left side slope, or right side slope, depending on the value entered. If you tap *No*, another message appears to warn you that point positions will be in two dimensions, and asks whether you want to continue. This option is useful if you need to stake out the 2D position of a feature not defined in the template (for example, the position of a lamppost).

- To select the next left/next right template element or the rightmost/leftmost element, tap *Offs>>*.

### Tips

- ◆ If you select an offset from the list, for all subsequent station values, the offset value is updated to reflect any widening or interpolation.
- ◆ If you enter an offset value, that value is maintained for all subsequent station values, even when the entered value corresponds to a value in the list.

Consider the following diagram. If you **select** offset 5 m at station 0 m, the offset value is updated to follow the solid line for subsequent stations. The value changes from offset 5 m to offset 8 m.

If you **enter** offset 5 m for the offset, the offset follows the dashed line. The offset of 5 m is maintained for subsequent stations.

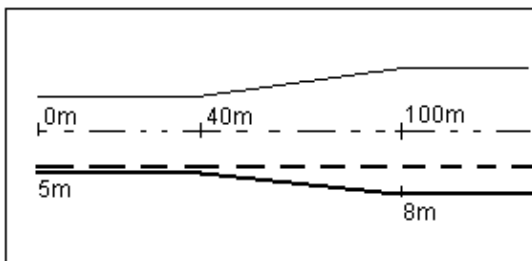

## Stakeout - Available Stations

When using Trimble or LandXML roads, to configure the stations available for the *Stations* field, select the appropriate check boxes in *Available Stations*, which you can access from the *Options* softkey in the *Stake out road* screen.

**Note** - This function is not available for roads derived from a GENIO file.

Select one of the following check boxes to make the appropriate stations available:

1. *Regular Sections* (stations defined by the station interval)
2. *Horiz. Curve* (key stations defined by the horizontal alignment)
3. *Vert. Curve* (key stations defined by the vertical alignment)
4. *Template* (stations where templates have been assigned)

5. *Super/Widen* (stations where superelevation and widening has been assigned)

## Position relative to a Trimble or LandXML road

To determine your current position relative to a Trimble or LandXML road:

1. In the *Stake* field, select *Position on road*.
2. Enter a value in the *Antenna/Target height* field and make sure that the *Measured to* field is set correctly.
3. If required, enter values in the *Construction offsets* fields.

**Note** - The *Vertical Offset* value specified here is not applied to a DTM surface.

4. Tap *Stakeout*.

The graphical display shows the:

- ◆ Road name
- ◆ Elevation of your current position (shown in blue)
- ◆ Design elevation of the road at your current position
- ◆ Center line (shown as a red line)
- ◆ Other linework (shown as blue lines)
- ◆ Positions that have not been staked (shown as open circles)
- ◆ Positions that have been staked (shown as solid circles)

The base of the screen reports your current position relative to the road in terms of:

- ◆ Station
- ◆ Offset to the centerline
- ◆ Vertical distance to the road surface

### Tips

- ◆ To view the Northing and Easting values for your current position, tap the arrow to the left of the navigation deltas.
- ◆ To view the [cross section](#) of your current position, tap the icon at the bottom right of the graphics window. Alternatively, press the [Tab] key on the controller to switch between the plan view and the cross section view.
- ◆ To access the status bar while the graphics window is in widescreen mode, tap the arrow on the far right of the screen. The status bar appears for approximately three seconds, after which time the window returns to widescreen.
- ◆ To change the widescreen mode tap and hold in the graphics window and then select *Widescreen*.

5. When the point is within tolerance, measure the point.

### Tips

- ◆ When using a GNSS receiver with an in-built tilt sensor, you can:
  - ◇ tap *eBubble* to display an electronic bubble
  - ◇ configure the survey style to prompt a warning when the pole is outside a specified *Tilt tolerance*
- ◆ Tap *Options* to configure the quality control, precision, and *tilt settings*.

## Notes

- If you are using a conventional instrument, the road values only appear after you take a distance measurement.
- If your current position is more than 30 meters from the road centerline, the graphical display navigates you to a position on the road centerline. This is calculated by projecting your current position at right angles to the centerline.
- If the road consists of only a horizontal and vertical alignment the *V.Dist* value will report the vertical distance to the centerline.
- The displayed road name is replaced with *Off road* if your current position is before the start of the road or beyond the end of the road.
- The displayed road name is replaced with *Undefined* when consecutive horizontal alignment elements are non tangential and your current position is beyond the end tangent point of the incoming element but before the start tangent point of the next element and you are on the outside of the road. See position 1 in the diagram below.
- When consecutive horizontal alignment elements are non tangential and your current position is before the end tangent point of the incoming element but after the start tangent point of the next element and you are on the inside of the road, the station and offset is reported relative to the closest horizontal element. See position 2 in the diagram below.

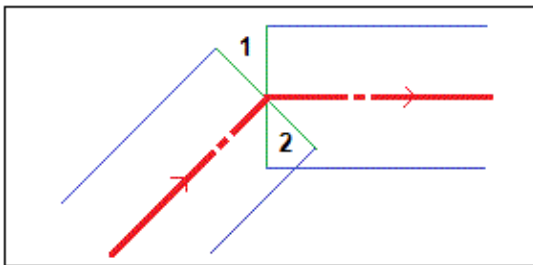

## Nearest offset

To stake relative to an offset for a Trimble or LandXML road:

1. In the *Stake* field, select *Nearest offset*.
2. Enter a value in the *Antenna/Target height* field and make sure that the *Measured to* field is set correctly.
3. Select an offset to stakeout. The *Nearest offset* stake option supports three stake out modes depending on how the offset is defined.
  - ◆ If you key in an offset value, that value is maintained for all subsequent station values. See *Understanding keyed in and selected offset behaviour* for further details.

Enter a negative value for an offset to the left of the centerline.  
Enter a positive value for an offset to the right of the centerline.

- ◆ If you select an offset from the list, the offset value updates to reflect any changes in geometry due to template changes or widening for all subsequent station values. See [Understanding keyed in and selected offset behaviour](#) for further details.

**Note** - The offsets available in the list is determined by the templates assigned at your current position relative to the road.

The *Code* field displays the code of the offset to be staked out. Roads uses the code from the template definition for the selected offset. When the offset is 0.000 m, the code defaults to CL.

- ◆ If you select *List* from the pop-up menu and select *Nearest offset* you will be navigated to the offset as defined by the template that is nearest to your current position.

4. If required, enter values in the [Construction offsets](#) fields.

**Tip** - Where an offset other than *Nearest* is selected, you can define a horizontal [construction offset](#) by your current position.

5. Tap *Stakeout* and then use either the plan or [cross section](#) graphical display to navigate along the offset.

The graphical display shows the:

- ◆ Code
- ◆ Elevation of your current position (shown in blue)
- ◆ Design elevation of the road at your current position
- ◆ Center line (shown as a red line)
- ◆ Other linework (shown as blue lines)
- ◆ Positions that have not been staked (shown as open circles)
- ◆ Positions that have been staked (shown as solid circles)

The base of the screen reports your current position relative to the string in terms of:

- ◆ Station
- ◆ Offset to the string
- ◆ Vertical distance to the string

### Tips

- ◆ To view the Northing and Easting values for your current position, tap the arrow to the left of the navigation deltas.
- ◆ To view the [cross section](#) of your current position, tap the icon at the bottom right of the graphics window. Alternatively, press the [Tab] key on the controller to switch between the plan view and the cross section view.
- ◆ To define a cross slope, see [Cross slope](#).

- ◆ To access the status bar while the graphics window is in widescreen mode, tap the arrow on the far right of the screen. The status bar appears for approximately three seconds, after which time the window returns to widescreen.
- ◆ To change the widescreen mode tap and hold in the graphics window and then select *Widescreen*.

6. When the point is within tolerance, measure the point.

### Tips

- ◆ When using a GNSS receiver with an in-built tilt sensor, you can:
  - ◇ tap *eBubble* to display an electronic bubble
  - ◇ configure the survey style to prompt a warning when the pole is outside a specified *Tilt tolerance*
- ◆ Tap *Options* to configure the quality control, precision, and *tilt settings*.

### Notes

- If you are using a conventional instrument, the road values only appear after you take a distance measurement.
- If you are staking to a [catch point](#) with construction offsets, navigate to the catch point first and then tap *Apply* to add the construction offsets. You are prompted to apply the offsets from your current position. If you are not on the catch position, select *No*, navigate to the catch position and then tap *Apply* again.

If you want to store the catch position and the construction offset, see [Construction offsets](#).

- To edit the side slope value or to select a new hinge offset, tap and hold in the graphics window and then select *Edit Side Slope*. See [Editing Side Slopes](#) for further details.
- A side slope is shown in red if edited.
- The displayed road name is replaced with *Off road* if your current position is before the start of the road or beyond the end of the road.
- The displayed road name is replaced with *Undefined* when consecutive horizontal alignment elements are non tangential and your current position is beyond the end tangent point of the incoming element but before the start tangent point of the next element and you are on the outside of the road. See position 1 in the diagram below.
- When consecutive horizontal alignment elements are non tangential and your current position is before the end tangent point of the incoming element but after the start tangent point of the next element and you are on the inside of the road, the station and offset is reported relative to the closest horizontal element. See position 2 in the diagram below.

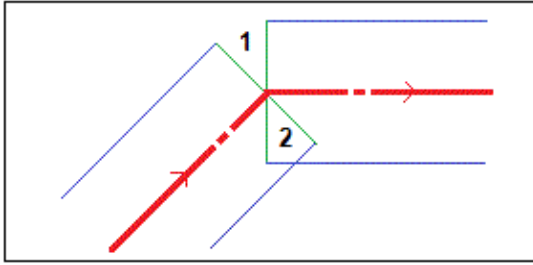

See also:

### Catch point

### Catch point staked deltas

### Understanding keyed in and selected offset behaviour

The behaviour at stake out differs depending on whether the offset was keyed in or selected. Consider the following diagram.

- If you **key in** 5m for the offset, the offset follows the dashed line. That is, the offset of 5m is maintained for subsequent stations.
- If you **select** offset 5m from the list, the offset value updates to follow the solid line for subsequent stations. That is, the offset updates to reflect any subsequent changes in geometry due to template changes or widening. In this example the offset changes from 5m to 8m between stations 40m and 100m and then is maintained at 8m for subsequent stations.

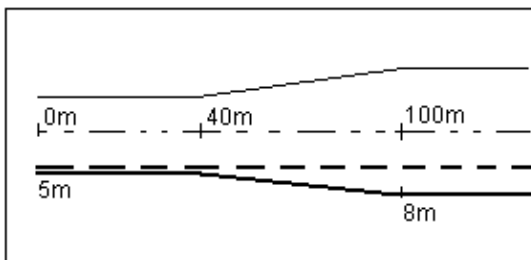

## Staking out a Side Slope Relative to an Alignment

To define and stake a side slope for a Trimble or LandXML road:

1. In the *Stake* field, select *Side slope from alignment*.
2. Enter a value in the *Antenna/Target height* field and make sure that the *Measured to* field is set correctly.
3. Enter the *Station interval* or accept the default value set when the road was defined.
4. Entering a value in the *Station* field. For more information, see the section [Selecting a station](#).
5. Select a *Hinge derivation* method and complete the appropriate fields. The following diagram explains the three hinge derivation methods:

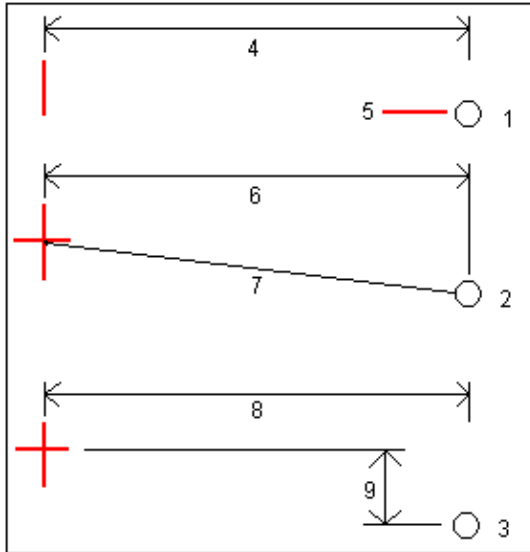

Key to the above diagram:

- 1 - Offset and elevation. Enter an offset (4) from the horizontal alignment, and the elevation (5) of the hinge position.
- 2 - Offset and slope. Enter an offset (6) from the horizontal alignment, and the slope value (7) from the intersection of the horizontal and vertical alignments to the hinge position.
- 3 - Offset and vertical distance. Enter an offset (8) from the horizontal alignment, and the vertical difference (9) from the intersection of the horizontal and vertical alignments to the hinge position.

**Note** - If the road definition consists of only a horizontal alignment, the only hinge derivation method available is Offset and elevation.

6. Complete the appropriate fields to define the [Side slope](#).
7. If required, enter values in the [Construction offsets](#) fields.
8. Tap *Stakeout* and then use either the plan or [cross section](#) graphical display to navigate to the point.

The graphical display shows the:

- ◆ Station value
- ◆ Code
- ◆ Side slope value defined by your current position (shown in blue)
- ◆ Design side slope value
- ◆ Elevation of your current position (shown in blue)

The base of the screen displays the navigation deltas.

When you are within 3m of the target the graphical display in the plan view shows your current position along with the target. Also displayed is a dashed line that connects the side slope catch position, (the point where the side slope intersects with the ground), to the side slope hinge position.

### Tips

- ◆ To select the delta display, tap the arrow to the left of the navigation deltas.
- ◆ Tap *Options* for further delta display options.
- ◆ To view the [cross section](#) of your current position, tap the icon at the bottom right of the graphics window. Alternatively, press the [Tab] key on the controller to switch between the plan view and the cross section view.
- ◆ To access the status bar while the graphics window is in widescreen mode, tap the arrow on the far right of the screen. The status bar appears for approximately three seconds, after which time the window returns to widescreen.
- ◆ To change the widescreen mode tap and hold in the graphics window and then select *Widescreen*.
- ◆ When you are within 3m of the target the graphical display in the plan view shows your current position along with the target. Also displayed is a dashed line that connects the side slope catch position, (the point where the side slope intersects with the ground), to the side slope hinge position.

9. When the point is within tolerance, measure the point.

### Tips

- ◆ When using a GNSS receiver with an in-built tilt sensor, you can:
  - ◇ tap *eBubble* to display an electronic bubble
  - ◇ configure the survey style to prompt a warning when the pole is outside a specified *Tilt tolerance*
- ◆ Tap *Options* to configure the quality control, precision, and *tilt settings*.

### Notes

- If you are staking to a [catch point](#) with construction offsets, navigate to the catch point and then tap *Apply* to add the construction offsets. You are prompted to apply the offsets from your current position. If you are not on the catch position, select *No*, navigate to the catch position and then tap *Apply* again.

If you want to store the catch position and the construction offset, see [Construction offsets](#).

- To also stake the appropriate hinge position, tap *Select>>* and select either the *Hinge point (Cut)* or *Hinge point (Fill)* option.

## Stakeout position from a file

To stake out a position from a CSV file relative to a Trimble or LandXML road, do this:

1. In the *Stake* field, select *Position from file*.
2. Enter a value in the *Antenna/Target height* field and make sure that the *Measured to* field is set correctly.
3. Select the position to stake.



The *Code* field shows the code, if available.

**Tip** - Use the *Next* and *Prev* softkeys to select the next or previous position in the file.

4. To edit the design elevation, tap the arrow. To reload an edited elevation, select *Reload original elevation* from the pop-up menu in the *Design elevation* field.

**Note** - If the position that you select for stakeout has no elevation, the *Design elevation* field becomes available. Enter an elevation into this field.

5. If required, enter values in the *Construction offsets* fields.
6. Tap *Start* and then use either the plan or [cross section](#) graphical display to navigate to the position.

The graphical display shows the:

- ◆ Station
- ◆ Code
- ◆ Elevation of your current position (shown in blue)
- ◆ Design elevation of the selected position (shown in red if edited)
- ◆ Center line (shown as a red line)
- ◆ Other linework (shown as blue lines)
- ◆ Positions that have not been staked (shown as open circles)
- ◆ Positions that have been staked (shown as solid circles)

The base of the screen displays the navigation deltas.

### Tips

- ◆ To select the delta display, tap the arrow to the left of the navigation deltas.
- ◆ Tap *Options* for further delta display options.
- ◆ To view the [cross section](#) of your current position, tap the icon at the bottom right of the graphics window. Alternatively, press the [Tab] key on the controller to switch between the plan view and the cross section view.
- ◆ To access the status bar while the graphics window is in widescreen mode, tap the arrow on the far right of the screen. The status bar appears for approximately three seconds, after which time the window returns to widescreen.
- ◆ To change the widescreen mode tap and hold in the graphics window and then select *Widescreen*.

7. When the point is within tolerance, measure the point.

### Tips

- ◆ When using a GNSS receiver with an in-built tilt sensor, you can:
  - ◇ tap *eBubble* to display an electronic bubble
  - ◇ configure the survey style to prompt a warning when the pole is outside a specified *Tilt tolerance*
- ◆ Tap *Options* to configure the quality control, precision, and *tilt settings*.

# Staking Roads from GENIO Files

The Roads software enables you to stake out a GENIO road by the following methods:

**Position on road**

**Along a string**

**Station on string**

The following tips help you to understand how to graphically activate the three methods of staking out a GENIO road:

- By default, the Roads software is in the *Position on road* method until you select a string to stake or a position to stake.
- To select a string to stake, tap the linework that represents a string in the plan view.
- To select a string and station to stake, tap the circle that represents the position in the plan view. Once you activate the string and station method, the **cross section** view is available. You can also graphically select positions from that view.
- To return to the *Position on road* method, tap in a clear space to clear the current selection, or reselect the current selection.
- To graphically activate a method, you must be in the plan view selection screen that appears immediately after you select the GENIO file and road, and tap *Start*.

**Tip** - If the master string has been excluded (the master string appears greyed out in the plan view and does not appear in the cross section view) and you want to stake it out, return to *Define*, tap and hold in the graphics view and then select *Exclude master at stakeout* from the pop-up menu.

**Note** - You must specify a coordinate system before you can stake out roads with the Roads software.

**Warning** - Do not stake out points and then change the coordinate system or perform a calibration. If you do, these points will be inconsistent with the new coordinate system and any points computed or staked out after the change.

## Tips

- During a conventional survey, you can use the tap and hold menu in the map to quickly measure a check point. If there are no points selected, *Check backsight* is available; if one point is selected *Check shot* is available.  
Alternatively, to measure a check shot from any screen, press [CTRL + K] on the controller.
- To improve performance when loading large GENIO files increase the available memory. The following is an indication of loading times for GENIO files:
  - ◆ For a 1 MB GENIO file the load time is approximately 20 seconds
  - ◆ For a 3 MB GENIO file the load time is approximately 1 minute

## Position relative to GENIO road

To determine your current position relative to a GENIO road:

1. Tap *Survey*, select a survey style and start a survey.

From the Trimble Access menu, tap *Settings / Survey styles* to edit an existing style or to define a new style.

2. Select a GENIO file and tap *OK*.

**Tip** - To add files from another folder to the list, tap *Add*, navigate to the required folder and then select the file(s) to add.

3. Select a road to stake and tap *Stakeout*.
4. Enter a value in the *Antenna/Target height* field.
5. Tap *Start*. The graphical point selection screen appears displaying the road. Because you want to know your position relative to the road, do not select a position to stake.

### Tips -

- ◆ Previously staked points are shown as solid circles.
- ◆ When you select *Start*, the software calculates the station values for all 3D strings relative to the 6D string for the road. The time taken to calculate the station values varies with the number of strings in the road and the length of the road. To improve performance when staking large GENIO files, Trimble recommends that you limit the number of strings in a road.

6. To define construction offsets, tap and hold in the graphics window and then select *Define construction offsets*.

**Note** - The *Vertical Offset* value specified here is not applied to a DTM surface.

**Tip** - To activate the pop-up menu if the touch screen has been disabled, press the space bar.

7. Tap *Stakeout*.

The graphical display shows the:

- ◆ Road name
- ◆ Elevation of your current position (shown in blue)
- ◆ Design elevation of the road at your current position
- ◆ Center line (shown as a red line)
- ◆ Other linework (shown as blue lines)
- ◆ Positions that have not been staked (shown as open circles)
- ◆ Positions that have been staked (shown as solid circles)

The base of the screen reports your current position relative to the road in terms of:

- ◆ Station value
- ◆ Offset to the centerline
- ◆ Vertical distance to the road surface

### Tips

- ◆ To view the Northing and Easting values for your current position, tap the arrow to the left of the navigation deltas.
- ◆ To view the [cross section](#) of your current position, tap the icon at the bottom right of the graphics window. Alternatively, press the [Tab] key on the controller to switch between the plan view and the cross section view.
- ◆ To access the status bar while the graphics window is in widescreen mode, tap the arrow on the far right of the screen. The status bar appears for approximately three seconds, after which time the window returns to widescreen.
- ◆ To change the widescreen mode tap and hold in the graphics window and then select *Widescreen*.

8. When the point is within tolerance, measure the point.

### Tips

- ◆ When using a GNSS receiver with an in-built tilt sensor, you can:
  - ◇ tap *eBubble* to display an electronic bubble
  - ◇ configure the survey style to prompt a warning when the pole is outside a specified *Tilt tolerance*
- ◆ Tap *Options* to configure the quality control, precision, and *tilt settings*.

### Notes

- To understand how your position is calculated between strings, see [String interpolation](#).
- If you are using a conventional instrument, the road values only appear after you take a distance measurement.
- If your current position is more than 30 meters from the road centerline, the graphical display navigates you to a position on the road centerline. This is calculated by projecting your current position at right angles to the centerline.
- The displayed road name is replaced with *Off road* if your current position is before the start of the road or beyond the end of the road.
- If the road consists of only a master string (6D), the *V.Distance* value will report the vertical distance to this string.

## Stakeout along a string

To stake out a GENIO road along a string:

1. Tap *Survey*, select a survey style and start a survey.

From the Trimble Access menu, tap *Settings / Survey styles* to edit an existing style or to define a new style.

2. Select a GENIO file and tap *OK*.

**Tip** - To add files from another folder to the list, tap *Add*, navigate to the required folder and then select the file(s) to add.

3. Select a road to stake and tap *Stakeout*.

4. Enter a value in the *Antenna/Target height* field.

5. Tap *Start*. The graphical selection screen appears displaying the road.

**Tips -**

- ◆ Previously staked points are shown as solid circles.
  - ◆ When you select *Start*, the Roads software calculates the station values for all 3D strings relative to the 6D string for the road. The time taken to calculate the station values varies with the number of strings in the road and the length of the road. To improve performance when staking large GENIO files, Trimble recommends that you limit the number of strings in a road.
6. To select a string from the plan view, do one of the following:
- ◆ Tap the linework that defines the string.
  - ◆ Tap and hold in the graphics window and then select a string from the list.
  - ◆ Tap and hold in the graphics window and then key in a string name.
  - ◆ If appropriate for your controller, tap any string and then press an left or right arrow key on the Trimble controller to navigate to the string.

The graphical display shows the name of the selected string.

**Tip** - To activate the pop-up menu if the touch screen has been disabled, press the space bar.

Once you select a string, tap the icon in the bottom right corner of the graphics window to view the cross section. To select a different string do one of the following:

- ◆ Tap the position that defines the string.
- ◆ Tap and hold in the graphics window and then select a string from the list.
- ◆ Tap and hold in the graphics window and then key in a string name.
- ◆ If appropriate for your controller, press an left or right arrow on the controller keyboard to select another string.

To return to the plan view, tap the icon again. Alternatively, press the [Tab] key on the controller to switch between the plan view and the cross section view.

To define a cross slope, see [Cross slope](#).

To define a subgrade, see [Subgrade](#).

**Note** - If the road includes multiple side slopes that define benched side slopes, only the 5D / Interface string that is furthest from the centerline will be converted to a side slope.

**Tip** - You can edit the design elevation of the string. To do this, tap and hold in the graphical window and then select *Edit elevation*. This will set the elevation for all positions along the string to the edited value. To reload an edited elevation, select *Reload original elevation* from the pop-up menu in the *Design elevation* field. This restores the elevation of all positions along the string to their design values. The edited elevation is shown in red.

8. To define construction offsets, tap and hold in the graphics window and then select *Define construction offsets*.

**Tip** - To activate the pop-up menu if the touch screen has been disabled, press the space bar.

9. Tap *Stakeout* and then use either the plan or *cross section* graphical display to navigate along the string.

The graphical display shows the:

- ◆ String name
- ◆ Elevation of your current position (shown in blue)
- ◆ Design elevation of the string at your current position (shown in red if edited)
- ◆ Center line (shown as a red line)
- ◆ Other linework (shown as blue lines)
- ◆ Positions that have not been staked (shown as open circles)
- ◆ Positions that have been staked (shown as solid circles)

The base of the screen reports your current position relative to the string in terms of:

- ◆ Station value
- ◆ Offset to the string
- ◆ Vertical distance to the string

### Tips

- ◆ To view the Northing and Easting values for your current position, tap the arrow to the left of the navigation deltas.
- ◆ To view the *cross section* of your current position, tap the icon at the bottom right of the graphics window. Alternatively, press the [Tab] key on the controller to switch between the plan view and the cross section view.
- ◆ To access the status bar while the graphics window is in widescreen mode, tap the arrow on the far right of the screen. The status bar appears for approximately three seconds, after which time the window returns to widescreen.
- ◆ To change the widescreen mode tap and hold in the graphics window and then select *Widescreen*.

10. When the point is within tolerance, measure the point.

### Tips

- ◆ When using a GNSS receiver with an in-built tilt sensor, you can:
  - ◇ tap *eBubble* to display an electronic bubble
  - ◇ configure the survey style to prompt a warning when the pole is outside a specified *Tilt tolerance*
- ◆ Tap *Options* to configure the quality control, precision, and *tilt settings*.

## Notes

- The Roads software interpolates elevation values along the string. For more information, see [String interpolation](#).
- For 5D / Interface strings, the target may not coincide with the design position because the target is calculated relative to your current position.
- If you are staking a [catch point](#) (5D / Interface string) with construction offsets, navigate to the catch point and then tap *Apply* to add the construction offsets. You are prompted to apply the offsets from your current position. If you are not on the catch position, select *No*, navigate to the catch position and then tap *Apply* again.

If you want to store the catch position and the construction offset, see [Construction offsets](#).

- If the string selected to stake is a 5D string Roads converts this string to a side slope. The calculated slope value is defined by the slope between the 5D string and the adjacent 3D string.

**Tip** - To configure the software to treat a 5D string as a 3D string, tap *Options* and then clear the *Auto side slope* option.

- For GENIO files defined from 12D Model, Roads treats all strings with a name that includes the letters INT as a 5D string and converts the string to a side slope. The calculated slope value is defined by the slope between the interface string and the adjacent 3D string.
- To edit the side slope value of a selected 5D / Interface string or to select a new hinge string, tap and hold in the graphics window and then select *Edit Side Slope*. See [Editing Side Slopes](#) for further details.
- A side slope is shown in red if edited.

## Stakeout station on string

To stake out a GENIO road by the string and station method:

1. Tap *Survey*, select a survey style and start a survey.

From the Trimble Access menu, tap *Settings / Survey styles* to edit an existing style or to define a new style.

2. Select a GENIO file and tap *OK*.

**Tip** - To add files from another folder to the list, tap *Add*, navigate to the required folder and then select the file(s) to add.

3. Select a road to stake and tap *Stakeout*.
4. Enter a value in the *Antenna/Target height* field.
5. Tap *Start*. The graphical selection screen appears displaying the road.

**Tips -**

- ◆ Previously staked points are shown as solid circles.
  - ◆ When you select *Start*, the Roads software calculates the station values for all 3D strings relative to the 6D string for the road. The time taken to calculate the station values varies with the number of strings in the road and the length of the road. To improve performance when staking large GENIO files, Trimble recommends that you limit the number of strings in a road.
6. To select a position from the plan view, do one of the following:
    - ◆ Tap the position.
    - ◆ Tap and hold in the graphics window and then select a string and station value from the list.
    - ◆ Tap and hold in the graphics window and then key in a string name and station value.
    - ◆ If appropriate for your controller, tap any position and then use the arrow keys on the Trimble controller to navigate to the position.

The graphical display shows the:

- ◆ Station
- ◆ String name
- ◆ Elevation of your current position (shown in blue)
- ◆ Design elevation of the selected position (shown in red if edited)
- ◆ Center line (shown as a red line)
- ◆ Other linework (shown as blue lines)
- ◆ Positions that have not been staked (shown as open circles)
- ◆ Positions that have been staked (shown as solid circles)

**Tip -** To activate the pop-up menu if the touch screen has been disabled, press the space bar.

The Roads software also supports staking nominal offset and station values. To do this, tap and hold in the graphics window, select the string to stake and then key in a numeric value that represents the offset. Similarly, from the *Station to stake* field, key in a nominal station value. For more information, see [String interpolation](#).

Once you select a position, tap the icon in the bottom right corner of the graphics window to view the cross section. To select a different position do one of the following:

- ◆ Tap the position.
- ◆ Tap and hold in the graphics window and then select a string and station value from the list.
- ◆ Tap and hold in the graphics window and then key in a string name and station value.
- ◆ Depending on the controller model, do one of the following:
  - ◇ Press an up or down arrow on the controller keyboard to select another station or the left or right arrow to select another string.



- ◇ Use the scroll bar to the right of the graphics window to select another station and then tap a position displayed on the screen to select another string.

To return to the plan view, tap the icon again. Alternatively, press the [Tab] key on the controller to switch between the plan view and the cross section view.

In the plan and cross section views, the bull's-eye icon (double circle) indicates the selected position. In the plan view, a selected string is shown with solid circles. To browse the string name, tap and hold on a string.

To define a cross slope, see [Cross slope](#).

To define a subgrade, see [Subgrade](#).

To stake relative to a secondary road, see [Secondary road](#).

**Note** - If the road includes multiple side slopes that define benched side slopes, only the 5D / Interface string that is furthest from the centerline will be converted to a side slope.

7. To edit the design elevation, tap and hold in the graphical window and then select *Edit elevation*. To reload an edited elevation, select *Reload original elevation* from the pop-up menu in the *Design elevation* field.

**Note** - An elevation is shown in red if edited.

8. To define a construction offsets, tap and hold in the graphics window and then select *Define construction offsets*.

**Tip** - To activate the pop-up menu if the touch screen has been disabled, press the space bar.

9. Tap *Stakeout* and then use either the plan or [cross section](#) graphical display to navigate to the position.

The graphical display shows the:

- ◆ Station value
- ◆ String name
- ◆ Elevation of your current position (shown in blue)
- ◆ Design elevation of the selected position (shown in red if edited)

The base of the screen displays the navigation deltas.

### Tips

- ◆ To select the delta display, tap the arrow to the left of the navigation deltas.
- ◆ Tap *Options* for further delta display options.
- ◆ To view the [cross section](#) of your current position, tap the icon at the bottom right of the graphics window. Alternatively, press the [Tab] key on the controller to switch between the plan view and the cross section view.
- ◆ To access the status bar while the graphics window is in widescreen mode, tap the arrow on the far right of the screen. The status bar appears for approximately three seconds, after which

time the window returns to widescreen.

- ◆ To change the widescreen mode tap and hold in the graphics window and then select *Widescreen*.

10. When the point is within tolerance, measure the point.

### Tips

- ◆ When using a GNSS receiver with an in-built tilt sensor, you can:
  - ◇ tap *eBubble* to display an electronic bubble
  - ◇ configure the survey style to prompt a warning when the pole is outside a specified *Tilt tolerance*
- ◆ Tap *Options* to configure the quality control, precision, and *tilt settings*.

### Notes

- For 5D / Interface strings, the target may not coincide with the design position because the target is calculated relative to your current position.
- If you are staking a *catch point* (5D / Interface string) with construction offsets, navigate to the catch point and then tap *Apply* to add the construction offsets. You are prompted to apply the offsets from your current position. If you are not on the catch position, select *No*, navigate to the catch position and then tap *Apply* again.

If you want to store the catch position and the construction offset, see [Construction offsets](#).

- If the string selected to stake is a 5D string Roads converts this string to a side slope. The calculated slope value is defined by the slope between the 5D string and the adjacent 3D string.

**Tip** - To configure the software to treat a 5D string as a 3D string, tap *Options* and then clear the *Auto side slope* option.

- For GENIO files defined from 12D Model, Roads treats all strings with a name that includes the letters INT as a 5D string and converts the string to a side slope. The calculated slope value is defined by the slope between the interface string and the adjacent 3D string.
- To edit the side slope value of a selected 5D / Interface string or to select a new hinge string, tap and hold in the graphics window and then select *Edit Side Slope*. See [Editing Side Slopes](#) for further details.
- A side slope is shown in red if edited.

## Staking relative to a secondary road

This function enables stakeout details from a secondary road to be referenced to a position being staked on a primary (current) road. See the following diagram:

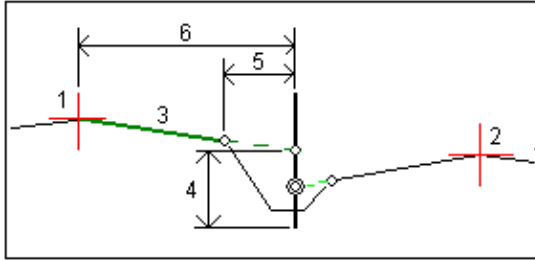

To do this:

1. Tap *Survey*, select a survey style and start a survey.

From the Trimble Access menu, tap *Settings / Survey styles* to edit an existing style or to define a new style.

2. Select a GENIO file and tap *OK*.

**Tip** - To add files from another folder to the list, tap *Add*, navigate to the required folder and then select the file(s) to add.

3. Select a road to stake and tap *Stakeout*.
4. Enter a value in the *Antenna/Target height* field.
5. Tap *Start*. The primary road is displayed. Select the position to stake.
6. From either the plan or cross section view, tap and hold in the graphics window and then select *Select secondary road* from the menu. From the list of roads, select the road representing the secondary road. The secondary road appears as unavailable in the plan view. From the plan view, you cannot select positions to stake on a secondary road.
7. From either the plan or cross section view, tap and hold in the graphics window and then select *View secondary cross section* from the menu. From the displayed cross section for the secondary road (1), tap the line (3) preceding the position you want to stake. A green line is projected to the stake position on the primary road (2).

**Note** - Stake details for the secondary road reported in the *As staked deltas* include:

- ◆ V.Distance to road (4)
  - ◆ Horizontal construction offset (calc'd) (5)
  - ◆ Distance to centerline (6)
8. Tap *Accept* to confirm your selection.
  9. Tap *Stakeout* to begin navigating using either the plan or **cross section** graphical display to navigate to the point.
  10. When the point is within tolerance, measure the point.

### Tips

- ◆ When using a GNSS receiver with an in-built tilt sensor, you can:
  - ◇ tap *eBubble* to display an electronic bubble

- ◇ configure the survey style to prompt a warning when the pole is outside a specified *Tilt tolerance*
- ◆ Tap *Options* to configure the quality control, precision, and *tilt settings*.

## String interpolation

The following rules apply to keyed-in station values:

- For a 6D string, the coordinates for keyed-in station positions are computed respecting the geometry of the string. Elevation values are computed by linear interpolation. However, if there is a 12D string coincident with the 6D string, the software uses the vertical alignment data available in the 12D string to compute the elevation values.
- For a 3D string, the coordinates for keyed in station values respect the horizontal geometry of the associated 6D string. Elevation values are computed by linear interpolation. However, if the deflection angle of the 3D string compared to that of the associated 6D string is greater than 30 minutes, the geometry of the associated 6D string will be ignored and the coordinates will be computed by linear interpolation instead. This is to avoid unexpected behavior when there is an acute change in direction in the 3D string for features such as slip lanes, bus bays, and so on.
- Interpolation between points along a transition is calculated using a clothoid spiral for 12D and 6D strings and approximated for 3D strings.

When measuring your position relative to a GENIO road or where your station and offset are nominal values your position is computed by linear interpolation from the nearest positions on adjacent strings.

In all situations where your position is interpolated, closer station intervals give greater accuracy.

## Staking Roads from LandXML Files

To stake out a LandXML road:

1. Tap *Survey*, select a survey style and start a survey.

From the Trimble Access menu, tap *Settings / Survey styles* to edit an existing style or to define a new style.

2. Select a LandXML file and tap *OK*.

**Tip** - To add files to the list from another folder, tap *Add*, navigate to another folder and then select the file to add.

3. If the file contains multiple roads select the road to be staked. To view a list of available roads, tap the arrow and then select *List*.
4. If the road contains multiple surfaces, select the surface to be staked out. To view the available surfaces, tap the arrow and then select *List*.

## Tips

- ◆ The LandXML format does not support side slopes. However, if the last element in the template(s) represents a side slope, select the *Set last template element as side slope* option to convert this element to a side slope. The slope value and direction of the element is then used to define the side slope. To edit the side slope (if required), use the **Select** softkey.
- ◆ If the elevations defining the cross sections are absolute, select the *Absolute design cross-section elevations* option to ensure the templates are resolved correctly.
- ◆ When selecting a LandXML file from 12d Model where the transition type is *cubic* you will be prompted to select the applicable cubic type. This is because the cubic type is not identifiable in the file. Choose from:
  - ◇ Cubic spiral
  - ◇ NSW cubic parabola

### 5. Select *Stakeout*.

When you stake a road in a LandXML file, the road is temporarily converted to a Trimble road, providing all the stakeout options available for a Trimble road. Choose from the following:

**Station and offset**

**Position on road**

**Nearest offset**

**Side slope from alignment**

**Position from file**

## Notes

- The Roads software does not provide stakeout for station values between template positions where the templates have a different number of elements.
- You must specify a coordinate system before you can stake out roads with the Roads software.
- The Roads software supports LandXML roads where the horizontal alignment is defined by elements or Points of Intersection (PI's). However LandXML files with curves defined by spiral-arc-connectingSpiral-arc-spiral are not supported.

**Warning** - Do not stake out points and then change the coordinate system or perform a calibration. If you do, these points will be inconsistent with the new coordinate system and any points computed or staked out after the change.

**Tip** - During a conventional survey, you can use the tap and hold menu in the map to quickly measure a check point. If there are no points selected, *Check backsight* is available; if one point is selected *Check shot* is available.

Alternatively, to measure a check shot from any screen, press [CTRL + K] on the controller.

# Editing Side Slopes

In some situations, you may need to edit the side slope. You can:

- Edit the *side slope value*
- Select a new *hinge position*

## Editing side slope values

1. Tap and hold in the either the plan or cross section graphics window and select *Edit Side Slope*.
2. Edit the as-designed cut and fill slope values for the selected station as required.

If there are no values at the top of the navigation screen for the design or calculated side slope, this means that ground conditions require the opposing slope value to be staked. You can edit the null (?) value.

3. In some situations, it may be preferable to adjust the cut or fill slope value to that of the next or previous template element. In either the *Cut slope* field or the *Fill slope* field, select *Next element slope* or *Previous element slope*. The *Slope* field updates with the appropriate slope value.

## Notes

- ◆ The next or previous element slope options are available only if the next or previous elements exist.
- ◆ In the *Cut slope* field, the options are available only if the next or previous slope values are positive, that is, if they define a cut slope.
- ◆ In the *Fill slope* field, the options are available only if the next or previous slope values are negative, that is, if they define a fill slope.
- ◆ A side slope is shown in red if edited.
- ◆ All edits are discarded after a position is measured or when you exit the stakeout screen.

The [diagram](#) belows shows a typical example of where you might use these options.

## Selecting a new hinge position

**Note** - Select *Hinge offset* (Trimble roads), or *Hinge string* (Genio roads).

1. Tap and hold in the either the plan or cross section graphics window and select *Edit Side Slope*.
2. From the *Hinge offset / Hinge string* field tap the arrow and then select a new position by one of these methods:
  - ◆ Tap a new position on the screen
  - ◆ Use the left/right arrow keys
  - ◆ Tap and hold on the screen and select the new position from the list

## Notes

- ◆ The current hinge position is shown as a solid blue circle.

- ◆ All edits are discarded after a position is measured or when you exit the stakeout screen.

The [diagram](#) belows shows a typical example of where you might select a new hinge position.

### Side slope editing diagram

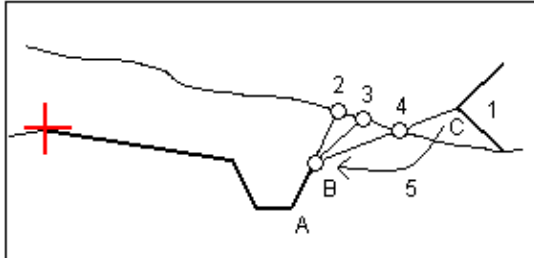

Key to the above diagram.

- 1 - Design side slope
- 2 - New catch position defined by the slope of the previous element (A - B)
- 3 - New catch position defined by the design cut slope value
- 4 - New catch position defined by the slope of the next element (B - C)
- 5 - Hinge position is moved from C to B to avoid an unwanted fill zone

## Specifying Construction Offsets

A point to be staked can be offset by a:

- [Horizontal offset](#)
- [Vertical offset](#)
- [Station offset](#) (available for roads from a GENIO file only)

A construction offset is indicated in the graphical display by a green line, with the double circle indicating the selected position adjusted for the specified construction offset(s).

### Tips

- Construction offsets are job-specific. That is, a construction offset specified for a road is not used for the same road when it is accessed from a different job.
- Construction offsets are format-specific. That is, a construction offset specified for a road is not used for roads of the other two road formats.
- Construction offsets are not road-specific. That is, a construction offset specified for a road is used for all roads of the same format in the same job.
- Construction offsets are not survey session-specific. That is, a construction offset specified for a road is used for subsequent survey sessions.

### Horizontal construction offsets

You can offset a point horizontally where:

- A negative value offsets the point towards the centerline (in).
- A positive value offsets the point away from the centerline (out).

Use the advanced pop-up arrow (  ) to specify if the offset is to be applied:

- Horizontal
- At the slope of the previous element in the cross section
- At the slope of the next element in the cross section

The following diagram shows a *Horizontal offset(1)* , *Slope previous offset(2)* and *Slope next offset(3)* applied to a position. For the *Slope previous* option, the slope of the offset is defined by the slope of the element (4) before the position (5) selected to stake. For the *Slope next* option, the slope of the offset is defined by the slope of the element (4) after the position (6) selected to stake. The *Vertical offset* value in the diagram is 0.000.

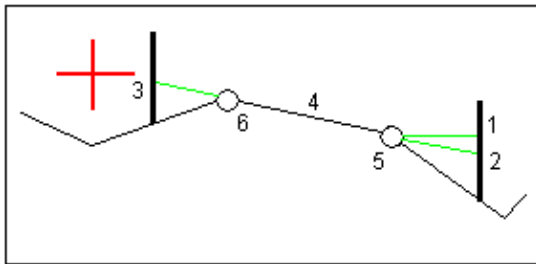

**Note** - For points with zero offset, you cannot apply construction horizontal offsets at the slope value of the previous template element.

Use the advanced pop-up arrow (  ) to specify if the offset is to be applied:

- Perpendicular to the master string for the sub string being staked
- Perpendicular to the sub string being staked

The following diagram shows a *Horizontal offset(1)* applied perpendicular to the master string(2) and a *Horizontal offset(3)* applied perpendicular to the sub string(4).

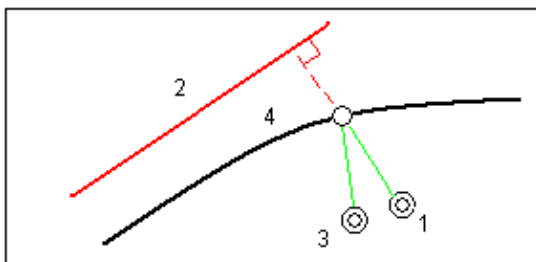

## Tips



- For Trimble and LandXML roads where the *Stake* option is *Station and offset* or *Nearest offset* (provided an offset other than *Nearest* is selected), you can define a horizontal offset by your current position. To do this:
  - ◆ Use the advanced pop-up arrow (  ) and select *Calculated*
  - ◆ Navigate to the position you want to place the stake. Note that the *Go left / Go right* navigation delta is replaced by the distance to the centerline when the horizontal offset is *Calculated*.
  - ◆ Measure and store the point

The calculated horizontal offset is reported in the *As staked deltas*.

- For GENIO roads where the stake option is *Station on string*, you can define a horizontal offset by the distance from the selected position to the master string. To do this:
  - ◆ Use the advanced pop-up arrow (  ) and select *At string*
  - ◆ Navigate to the target which will be at the master string
  - ◆ Measure and store the point

The calculated horizontal offset is reported in the *As staked deltas*.

This option is not available if the string being staked is a 5D string or if the horizontal offset is applied perpendicular to the sub string.

- For GENIO roads where the stake option is *Station on string* or *Along string*, you can define a horizontal offset by the distance from the selected position to your current position. To do this:
  - ◆ Tap the advanced pop-up arrow (  ) and then select *Calculated*.
  - ◆ Navigate to the position where you want to place the stake. Note that the *Go left / Go right* navigation delta is replaced by the calculated horizontal construction offset.
  - ◆ Measure and store the point

The calculated horizontal offset is reported in the *As staked deltas*.

This option is not available if the horizontal offset is applied perpendicular to the sub string.

## Notes

- If you enter a value for the horizontal offset on the centerline (at offset 0.00 m), a negative value offset is to the left.
- Construction offsets are not automatically applied to a side slope offset. For more information, see staking a [Catch point](#).
- When you stake a side slope, select the *Store both catch and construction offset* check box if you want to measure **and** store the catch position.

## Vertical construction offsets

You can offset a point vertically where a:

- Negative value offsets the point vertically down.
- Positive value offsets the point vertically up.

In the *Vertical offset* field, use the advanced pop-up arrow (  ) to specify if the offset is to be applied:

- Vertically
- Perpendicular to the element in the cross section before the point being staked

The following diagram shows a *Vertical offset* applied vertically(1) and a *Vertical offset* applied perpendicular(2) to the previous cross section element(3).

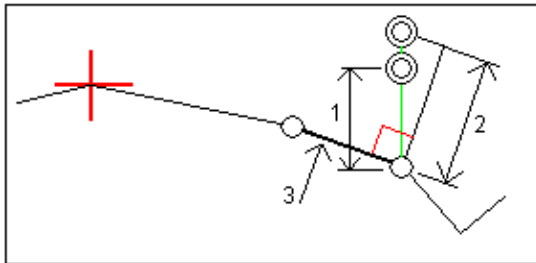

### Station construction offsets

For roads derived from a GENIO file you can offset a point along the station of the selected string where a.

- Positive value offsets the point in the direction of increasing station (Forward).
- Negative value offsets the point in the direction of decreasing station (Backward).

### Notes

- You cannot apply a Station offset to a 5D string that represents the catch position.
- The Station offset respects the geometry of the string being staked.

## Cross Section View

The cross section that appears is orientated in the direction of increasing station. Your current position and the target are shown. If the target has construction offsets specified, the smaller single circle indicates the selected position and the double circle indicates the selected position adjusted for the specified construction offset(s). The construction offset(s) appear as green lines.

When you view the cross section, the appropriate cut or fill side slope appears for the side of the road that you are currently on.

For all road formats, see [Cross slope](#) to graphically define a cross slope.

For roads defined in a GENIO file, see [Subgrade](#) to graphically define a subgrade.

## Catch Point

The catch point is the point where the design side slope intersects with the ground.

The actual intersection position of the side slope with the existing ground surface - the catch point - is determined iteratively (by repetition). The Roads software calculates the intersection of a horizontal plane passing through the current position, and either the cut or fill side slope, as shown in the following diagram , where  $x_n$  is the *Go Right/Left* value.

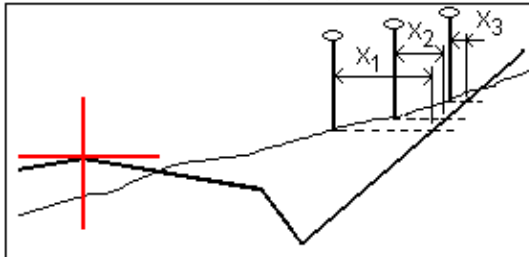

The graphical display in the plan view, shows the calculated catch position. The calculated slope value (in blue) and the design slope value appears at the top of the screen.

To view the [cross section](#) of your current position, tap the icon at the bottom right of the graphics window. Alternatively, press the [Tab] key on the controller to switch between the plan view and the cross section view.

The cross section is displayed looking in the direction of increasing station. Your current position and the calculated target are indicated. A line is drawn (in blue) from the hinge position to your current position to indicate the calculated slope.

If the catch point has construction offsets specified, these appear in the cross-section view as green lines. The smaller single circle indicates the calculated catch position and the double circle indicates the selected position adjusted for the specified construction offset(s). The construction offsets appear only after you have applied them.

**Note** - For side slope offsets where the slope changes between templates, the Roads software calculates the side slope for intermediate stations by interpolating the slope value.

From the *Confirm staked deltas* screen (or *Review job* ) tap [Report](#) to view the *Catch point deltas report* screen.

### The Select softkey

The Select softkey provides the following options related to staking a side slope. This applies to Trimble and LandXML roads only.

Option	Description
<i>Catch point (Auto)</i>	The Roads software selects the side slope (cut or fill) to intersect with the ground. This is the default.

<i>Catch point (Cut)</i>	Fixes the side slope as a cut side slope.
<i>Catch point (Fill)</i>	Fixes the side slope as a fill side slope.
<i>Hinge point (Cut)</i>	Stakes out the base of the cut side slope. This is the most direct way to select the hinge point if the template includes a ditch offset.
<i>Hinge point (Fill)</i>	Stakes out the start of the fill side slope.

## Catch Point Staked Deltas

If you have the *View before storage* check box in the *Stakeout* options selected, the *Confirm staked deltas* screen appears before you store the point.

The Roads software supports user definable stakeout reports, which enable you to configure the display of staked information on the *Confirm staked deltas* screen that appears when you enable *View before storage*. For more information, see [As-Staked Point Details](#).

**Note** - The value in the *S.Distance to hinge + Constr off* field includes any construction offset values specified and reports the slope distance from the hinge to the as-staked position. The value is null (?) if there is no horizontal construction offset specified or the horizontal construction offset is applied horizontally.

**Tip** - Tap *Report* to view the *Catch point deltas report* screen. This screen shows the horizontal and vertical distances from the catch point to the end of each template element, up to and including the centerline. If the template includes a cut ditch, the report includes the hinge position at the toe of the cut slope. The reported values exclude any construction offset specified.

The following diagram explains some of these fields.

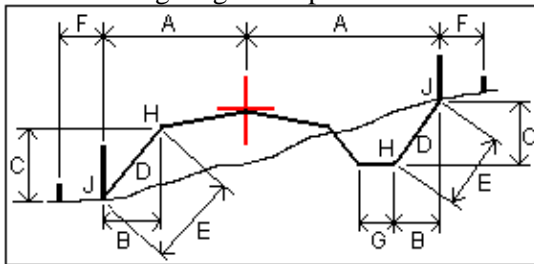

Where:

A	=	Distance to center line
B	=	Horizontal distance to hinge point
C	=	Vertical distance to hinge point
D	=	Slope
E	=	Slope distance to hinge point
F	=	Horizontal construction offset

G	=	Ditch offset
H	=	Hinge point
J	=	Catch point

**Note** - When you stake a fill side slope with a subgrade, the as staked deltas include the distance from the catch to the intersection of the subgrade with the side slope. Available for GENIO roads only.

## Defining a cross slope

You can use this special construction offsetting tool with Trimble, GENIO, and LandXML roads. Activate it graphically from the cross section view when in selection mode for GENIO roads and when in stakeout mode for Trimble and LandXML roads. Cross sloping enables you to stake two positions in a single operation, as shown in the following diagram:

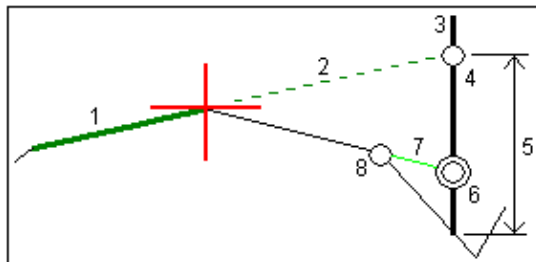

To do this:

1. Define a horizontal construction offset, typically at *Slope previous* and enter a vertical offset, if required.
2. The smaller single circle (8) indicates the selected position and the double circle (6) indicates the selected position adjusted for the specified construction offsets. The construction offset(s) appear as a green line (7).
3. Tap the line (1) that will define the cross slope. From the pop-up menu select *Define cross slope* and optionally enter a *Cross slope offset*.
4. The selected line appears as a bold green line. A dashed green line (2) extends from the selected line to intersect with a vertical line (4) at the target stake (3).
5. Navigate to the target and then stake the position.
6. From the *Confirm staked deltas* screen use the *V.Distance cross slope* value (5) to mark the stake with the second position.

**Note** - The defined cross slope applies to all subsequent stations. To de-activate the cross slope function, tap the selected line (1).

## Defining a subgrade

This special subgrade calculation tool for GENIO roads is activated graphically from the cross section view when in selection mode. It enables you to stake a position at an offset to a line, as shown in the following

diagram:

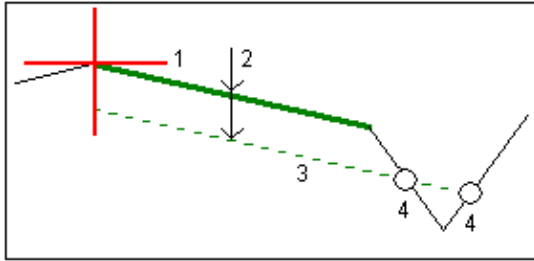

To do this:

1. From the cross section view, tap the line (1) that will define the subgrade. The selected line appears green and bolded.
2. From the pop-up menu, select *Define subgrade*.
3. Enter the depth to subgrade (2) where the depth is from the selected line to the subgrade surface.
4. The dashed green line (3) that appears is parallel to the line selected and offset by the depth to the subgrade. The line extends to intersect with all encountered lines in the cross section. The single circles (4) indicate the computed positions.
5. Tap the computed position that you want to stake.
6. Navigate to the target and then stake the position.

**Note** - The defined subgrade applies to all subsequent stations. To de-activate the subgrade function, tap the selected line (1).

# File Transfer

## Report - Export Custom Format Files

Use the *Report* option to create custom ASCII files on the controller while in the field. Use the predefined formats or create your own custom formats. With custom formats, you can create files of almost any description. Use these files to check data in the field, or to produce reports, which you can transfer from the field to your client or to the office for further processing with the office software.

You can modify a predefined format to meet your specific requirements, or use it as a template to create a completely new custom ASCII export format.

### To create a report of survey data:

1. Open the job that contains the data to export.
2. From the Roads menu, tap *Report*.
3. In the *File format* field, specify the type of file to create.
4. Tap  to select an existing folder or create a new one.
5. Enter a filename.

By default, the *File name* field shows the name of the current job. The filename extension is defined in the XSLT style sheet. Change the file name and extension as required.

6. If more fields are displayed, complete them.

You can use the XSLT style sheets to generate files and reports based on parameters that you define. For example, when generating a Stakeout report, the *Stakeout horizontal tolerance* and the *Stakeout vertical tolerance* fields define acceptable stakeout tolerances. When generating the report you can stipulate the tolerances, then any stakeout delta greater than the defined tolerances appears in color in the generated report.

7. To automatically view the file after you create it, select the *View created file* check box.
8. To create the file, tap *Accept*.

**Note** - When the selected XSLT style sheet is applied to create the custom export file, the processing is all carried out in the program memory available on the device. If there is not enough memory to enable the creation of the export file, an error message will be displayed and no export file will be created.

Four factors will affect whether the export file can be created

1. The amount of program memory available to the device.
2. The size of the job being exported.
3. The complexity of the style sheet being used to create the export file.
4. The amount of data being written to the export file.

If it is not possible to create the export file on the controller, download the job as a JobXML file to a computer.

To create the export file from the downloaded JobXML file using the same XSLT style sheet, use the ASCII File Generator utility program (available from [www.trimble.com](http://www.trimble.com)).