



HELP

TRIMBLE® ACCESS™
SOFTWARE

MINES

Version 2.40
Revision A
February 2014



Table of Contents

Introduction Mines.....	1
Introduction.....	1
Interacting With Other Applications.....	2
Job Operations.....	3
Jobs.....	3
Properties of Job.....	4
Review Job.....	5
Point Manager.....	9
Map.....	16
3D Map.....	20
Using the Map for Common Tasks.....	24
Selecting points.....	28
Units.....	29
Cogo Settings.....	31
Auto Stakeout - points and lines.....	37
Additional Settings.....	37
Export Custom Format Files.....	37
Import Custom Format Files.....	37
Survey - General.....	39
Measure Codes.....	39
Conventional Survey - Setup.....	44
Conventional Survey: Getting Started.....	44
Configuring Conventional Survey Styles.....	44
Configure Topo Point Settings.....	44
Preparing for a Robotic Survey.....	45
Station Setup.....	46
Station setup plus.....	48
Measuring Rounds in Station setup plus or Resection.....	52
Station Elevation.....	55
Resection.....	56
Reflines.....	61
Station setup plus, Resection, and Rounds Options.....	62
Conventional Instrument - Corrections.....	64
Target Details.....	66
Prism Constant.....	70
Advanced Geodetic Support.....	71
Start the Survey.....	71
End the survey.....	72
Conventional Survey - Measure.....	73
Measure Points.....	73
Measuring topo points in a Conventional Survey.....	74

Table of Contents

Conventional Survey - Measure

Measuring a Point in Two Faces.....	75
Continuous topo - Conventional.....	77
Angles and distance.....	78
Averaged Observations.....	78
Angle Offset, H. Angle Offset, and V. Angle Offset.....	79
Distance Offset.....	80
Measure Points on a Plane.....	81
Measure 3D axes.....	82
Dual-prism Offset.....	83
Circular object.....	84
Measure Rounds.....	85
Remote Object.....	89
Scanning.....	90
Surface Scan.....	95
Check Point.....	98
Fast Fix.....	99

Survey - Stakeout.....100

Stakeout - Configuring the Display Mode.....	100
Stakeout - Using the Graphical Display.....	101
Stakeout - Options.....	102
As-Staked Point Details.....	103
Stakeout - Points.....	105
Stakeout - Lines.....	109

Mines - Auto Stakeout.....112

Mines - Auto stake.....	112
Auto stake Center line.....	113
Auto stake Grade line.....	114
Auto stake Laser lines.....	116
Auto stake Laser line from center line.....	117
Auto stake Project Line.....	118
Auto stake Blast holes.....	120
Auto stake Pivot points.....	121
Settings.....	122

Reports.....123

Generating a report.....	123
--------------------------	-----

Introduction Mines

Introduction

Welcome to the Mines software version 2.40 Help.

This help system makes it easy to find the information you need to effectively use the full power and capabilities of the Mines software.

For information that extends or updates this Help, refer to the Trimble Access Release Notes. Alternatively, visit the Trimble website (www.trimble.com) or contact your local Trimble dealer.

To use this application with other applications, see [Interacting with other applications](#).

Contents

From the Trimble Access menu tap Mines to:

- Manage your jobs
 - ◆ [Create](#) a new job
 - ◆ [Open](#) an existing job
 - ◆ [Review](#) the current job
 - ◆ Access the [Point manager](#)
 - ◆ See the [Map](#)
 - ◆ Review and edit the [Job properties](#)
 - ◆ [Import](#) ASCII files into the current job
- Measure
 - ◆ [Measure topo](#) points
 - ◆ [Measure codes](#)
 - ◆ [Measure 3D axes](#)
 - ◆ [Continuous topo](#)
 - ◆ [Surface scan](#)
- Stakeout
 - ◆ [Stakeout point](#)
 - ◆ [Stakeout line](#)
- Auto Stakeout
 - ◆ Auto stake [Center line](#)
 - ◆ Auto stake [Grade line](#)
 - ◆ Auto stake [Laser lines](#)
 - ◆ Auto stake [Laser lines from center line](#)
 - ◆ Auto stake [Blast holes](#)
 - ◆ Auto stake [Pivot points](#)
- [Reports](#)

Legal Notices

Interacting With Other Applications

You can run more than one application at a time and easily switch between them. For example, you can switch between functions in *Roads*, *Tunnels*, *Mines*, and *General Survey*.

To run more than one application at a time, use the Trimble button or Trimble icon in the top left corner of the screen to open the Trimble Access menu. From there, you can run the other application.

To switch between applications:

- Tap the Trimble button in the task bar to access the menu of available applications and services currently running, including the Trimble Access menu. Select the application or service to switch to.
- On the TSC2/TSC3 controller, a short press of the Trimble button accesses the menu of available applications and services currently running, including the Trimble Access menu. Select the application or service to switch to.
- On the Trimble GeoXR controller, tap the Trimble button to access the menu of available applications and services currently running, including the Trimble Access menu and the Windows *Start Menu*. Alternatively, press and hold the camera button for two seconds and then select the application or service to switch to.
- Tap *Switch to* and then select the required function from the list. If the *Switch to* button is not on your current screen, press **CTRL W** to open the *Switch to* pop-up list.
- Press **CTRL TAB**. This is the keyboard shortcut to scroll through the current list of *Switch to* functions.
- Tap *Favourites* or press **CTRL A** to select a preconfigured favorite.
- On a TSC2/TSC3 controller, configure the [Left App] button and [Right App] button for the functions you want to run. This method opens an application even if that application is not running.

For more information, see [Trimble Access Buttons](#).

Tip - You can use this functionality to return to the main menu of the application you are currently running e.g. if you are running the *Define* option in Trimble Access Roads and you want to view the *Map*, tap the Trimble button and select Trimble Access Roads from the drop down list.

Job Operations

Jobs

A job can contain several different surveys. Select a job before you measure any points or make any calculations.

Jobs can be saved in your data folder, or in a [project folder](#) below your data folder.

Jobs that are defined in one Trimble Access application, for example, General Survey can be used in another application, for example, Roads.

To create a new job:

1. From the main menu, tap *Jobs / New job*.
2. Enter a name for the new job.
3. Tap  to create a new folder or select an existing folder.
4. Select a [Template](#) from the drop down list.
5. Tap the *Coord. sys.* button and choose a [coordinate system](#) for the job. Tap *Next*.
6. Configure the coordinate system settings required for the job and tap *Store*.
7. Tap the [Units](#) button to specify the units and various other settings for the job. Tap *Accept*.
8. Tap the [Linked files](#) button to select a linked file(s) for the job. Tap *Accept*.
9. Tap the [Active map](#) button to select an active map file(s) for the job. Tap *Accept*.
10. Tap the [Feature library](#) button to associate a feature library with the job. Tap *Accept*.
11. Tap the [Cogo settings](#) button to set the cogo settings for the job. Tap *Accept*.
12. Tap the [Additional settings](#) button to set additional settings for the job. Tap *Accept*.
13. Tap the [Media file](#) button to set the media settings for the job. Tap *Accept*.
14. Optionally, tap the *Page down* button to enter *Reference*, *Description* and *Operator* details, and any *Notes*.
15. Tap *Accept* to save the job.

A new job adopts the system settings from the last used job.

To open a job:

1. From the main menu, tap *Jobs / Open job*.
2. Tap  to expand a folder and display the files within the folder.
3. Tap the job name, or highlight the job name and tap *OK*.
The job name appears in the title area of the main menu.

To delete a job:

1. From the main menu, tap *Jobs / Open job*.
2. Tap  to expand a folder and display the files within the folder.

If the job you want to delete is not highlighted, use the arrow keys to highlight it, or tap and hold it with the stylus.



Note - If you tap with the stylus without holding, the job that you highlight opens automatically.

3. Tap  to delete the file.
4. Tap *Yes* to confirm deletion, or *No* to cancel.

Note - When you delete a job, associated files (for example, *.t02, *.tsf *.jpg) are not automatically deleted.

Tip - You can also use [Fn+ Del] on the TSC2/TSC3 controller or [Ctrl + Del] on the Trimble CU/Trimble Tablet to delete jobs from the *File / Open* dialog.

To copy a job:

1. From the main menu, tap *Jobs / Open job*.
2. Highlight the name of the job to be copied and tap .
3. Browse and highlight the folder to paste the file into and tap .

Tip - You can also use *Windows/File Explorer* to copy, rename, or delete a file.

Note - When you copy a job to another folder, associated files (for example, *.t02, *.tsf *.jpg) are not automatically copied.

To create a new job with all the defaults (including Coordinate System settings) from another job:

1. From the main menu, tap *Jobs / Open job*.
2. Tap  to select the folder, if required.
3. Select and open the job that contains the settings to use as the defaults for the new job.

Note - To use the settings in the **current** job as defaults for the new job, omit steps 1 and 2. New jobs always use the settings from the previous job as defaults.

4. From the main menu, tap *Jobs / New job*.
5. Enter a name for the new job.
6. Tap the appropriate button to change job settings as required.
7. To save the job, tap *Accept*.

Properties of Job

Use this menu to configure settings for the current job.

For more information, see:

[Coordinate system](#)

[Linked files](#)

[Active map files](#)

[Feature library](#)

[Additional settings](#)

[Media file](#)

Each button displays the current settings. When you create a new job, settings from the previous job are used as the defaults. Tap a button to change the settings.

Tap *Accept* to save any changes.

To configure the Units and Cogo settings, tap *Settings* from the Trimble Access menu and then tap *Units Cogo*.

Review Job

To see the records stored in the job database:

1. From the main menu, tap *Jobs / Review job*.
2. Use the arrow keys, stylus, or softkeys to navigate the database.

Tips

- ◆ To move to the end of the database quickly, highlight the first record and press the up arrow key.
 - ◆ To highlight a field without selecting it, tap and hold briefly with the stylus.
3. To see more information about an item, tap the record. Certain fields, for example, *Code* and *Antenna height*, can be edited.
 - ◆ Offset points that are stored as coordinates are not updated when you change an antenna or target height record in the database. In addition, a change in antenna height does not affect any postprocessed points that will be processed using the Trimble Business Center software. Verify the antenna or target height information when you transfer the data to the office computer or transfer postprocessed points directly from the receiver to the office software. When you change an antenna or target height record in the database, stakeout deltas, Cogo points, averaged points, calibrations, resections, and traverse results are not automatically updated. Re-observe staked out points, and re-calculate Cogo points, averaged points, calibrations, resections, and traverses.
 - ◆ To search for a particular item, tap *Search* and select an option.

Tip - To review features from the *Map* screen, select the required feature(s), tap and hold on the

screen and choose *Review* from the shortcut menu.

To change the coordinate view display in *Review job*:

1. From the main menu, tap *Jobs / Review job*.
2. Use the arrow keys, stylus, or softkeys to navigate the database.
3. Do one of the following:
 - ◆ Tap + to expand the point tree list.

To change the coordinate display, tap one of the ordinates and then select the appropriate coordinate view from the list;

Grid, Grid (local), WGS84, HA VA SD (raw), As Stored.

- ◆ Tap the point name to view details about the point.

To change the ordinate display:

- a. Tap *Options* and then select the appropriate *Coordinate view* from the list; As Stored, Local, Grid, Grid (local), ECEF (WGS84), Station and offset, Az VA SD, HA VA SD (raw), Az HD VD, HA HD VD, delta Grid, USNG/MGRS.

If you selected *Station and offset*, select the entity type (Line, Arc, Alignment, Tunnel or Road) and the name of the entity the points position will be referenced from.

If you selected *Grid (local)*, select the *Transformation for grid (local) display* name. This transformation transforms the grid coordinates to Grid (local) coordinates using the selected transformation.

Unless the transformation selected here is the same as the input transformation, the Grid (local) coordinates shown will not match the original Grid (local) coordinates. To see the original Grid (local) coordinates, set the Coordinate view to *As Stored*.

Transformation (as stored) is displayed when reviewing Grid (local) and the *Coordinate view* is set to As Stored.

Transformation (display) is displayed when reviewing Grid (local) and the *Coordinate view* is set to Grid (local).

- b. Tap *Accept*.

To view a media file:

1. Highlight a media file record.

Tip - To highlight a field without selecting it, tap and hold briefly with the stylus.

2. Tap *Details*. The image appears.

Inserting notes

To store a note in the database:

1. Highlight a record.
2. Tap *Note*. The *Note* screen that appears displays the date and time that the current record was created.
3. Enter the note and then tap *Accept*. The note is stored with the current record. In *Review job*, the note appears below the record with the note icon.

Editing target/antenna records using Review job

Select *Review job* to edit existing antenna or target height records. These edits change the antenna or target height for all observations using that antenna or target height.

To edit a target/antenna record:

1. Tap the target/antenna record. The current target (conventional survey) or antenna (GNSS survey) details appear.
2. Enter the new details and then tap *Accept*.

The current record is updated with the new details, which apply to all subsequent observations using that record.

A note with a timestamp is attached to the record. This note documents the old details, including when the changes were made.

Editing target/antenna records using Point manager

Use [Point manager](#) to easily change the target or antenna height of a single observation or any number of observations.

Editing codes using Review job

If you have only a single code to edit, you can use *Review job*.

To edit a code:

1. From the main menu, tap *Jobs / Review job*.
2. Tap the observation record that contains the code you want to edit.
3. Change the code and then tap *Accept* to store the changes.

The Note stored with the observation is a record of the old code and the date and time it was modified.

Editing codes using Point Manager

You can use *Point manager* to edit single or multiple codes.

When you edit multiple codes, the *Point manager* is easier to use than *Review job*.

For more information, see [Point manager](#).

Editing point names and point coordinates using Point Manager

You can use *Point manager* to edit point names or point coordinates.
You cannot edit point names and point coordinates using *Review job*.

Deleted points, lines, and arcs



A deleted point, line, or arc is not used in calculations, but it is still in the database. Deleting points, lines, or arcs does not make a job file smaller.

When you transfer a file that contains deleted points, the deleted points are not transferred to the office software. If you transfer a file using the Trimble Data Transfer utility, however, the deleted points are recorded in the Data Collector (.dc) file. They have a classification of Deleted.

Some points, such as continuous offset points and some intersection and offset points, are stored as vectors from a source point. If you delete a source point, any point stored as a vector from that point has null (?) coordinates when you review the database point record.

To delete a point, line, or arc in the General Survey database:

1. From the main menu, tap *Jobs / Review job*.
2. Highlight the point, line, or arc to be deleted and tap *Details*.
3. Tap *Delete*. For points, the search class changes to Deleted (normal), Deleted (control), Deleted (staked), Deleted (backsight), or Deleted (check), depending on the original search classification.
4. Tap *Accept*. The General Survey software records a note with the original point, line, or arc record, showing the time it was deleted.

When you delete a point, line, or arc, the point symbol changes. For example, for a topo point, the  symbol replaces the  symbol.

When you delete an observation that has been recorded during a [Station setup plus](#), a [Resection](#), or [Measure rounds](#) operation, the mean turned angle records and station or round residuals records will not be updated. Deleting an observation that has been used to compute an average does not automatically update the average. Use *COGO / Compute average* to recompute the average.

Tips

To delete features from the *Map* screen:

You cannot delete points from a linked file.

Use Explorer to delete alignment files, road files, map files, or any other file type stored on the controller.

Note - You cannot delete points, lines or arcs from a linked map file (for example, a DXF or SHP file).

To restore a point, line, or arc in the General Survey database:

1. From the main menu, tap *Jobs / Review job*.
2. Tap the point, line, or arc record to be restored.
3. Tap *Undelete*.

4. Tap *Accept*.

Point Manager

As an alternative to *Review job*, use the *Point manager* to manage your data.

You can easily review:

- Point coordinates
- Observations
- The **best point** and all duplicate points
- Target and antenna heights
- Codes and notes
- Descriptions
- Notes

You can easily edit:

- Target and antenna heights (single or **multiple**)
- **Point names**
- **Point coordinates**
- Codes (single or **multiple**)
- Descriptions (single or multiple)
- Notes

Using Point manager

To open *Point manager*, select *Jobs / Point manager* from the main menu. The screen that appears shows a tabulated tree structure of all points and observations in the job database and linked files.

Viewing the data

When there are duplicate points of the same name, the best point always appears first. All occurrences of points of the same name, including the best point, appear in a list below the best point. However, when the data is in the *Target height* view, all observations in the database appear in the order that they occur in the database.

To change the view of the data, select *Display*. For example, to view coordinates, set *Display* to Grid; to view or edit target heights, set *Display* to Target height.

Note - In *Point manager*, the *Target height* setting refers to both antenna height and target height.

To sort the data, tap the column heading.

To change the width of the column, or to hide the column, tap and drag the separator between headings.

To shrink an empty column double tap the separator to the right of the column.

Use the scroll bars to scroll horizontally or vertically through the data.

Tip - To freeze the Point name column, tap and hold the Point name column heading. To unfreeze the column, tap and hold the heading again.

To filter the displayed information using wildcard matching, tap  . The screen that appears contains *Point name*, *Code*, and *Note* fields and, if enabled, two *Description* fields.

To filter the fields appropriately, use * (for multiple characters) and ? (for a single character). The filters specified for the separate fields are processed together and only points that meet the criteria of all the filters will appear. Use * in any field that you do not want to filter. Filtering is not case sensitive.

Filter examples:

Point name	Code	Descr. 1	Descr. 2	Note	Example results
1	*	*	*	*	1, 10, 2001, 1a
1*	*	*	*	*	1, 10, 1a
1?	*	*	*	*	10, 1a
1	Fence	*	*	*	All points with a name that contains a 1 and where code = Fence
1	*Fence*	*	*	*	All points with a name that contains a 1 and a code that contains Fence
1???	*	*	*	wrong*	All points with a name that starts with 1 and is 4 characters long and a note that starts with wrong
*	Tree	Aspen	25	*	All points where code = tree and Description 1 = Aspen and Description 2 = 25

To disable the filter, tap *Reset*, or set all fields to *.

Filter settings are remembered, but are not applied if Point manager is closed. To reactivate filter settings, tap  and then tap *Accept*.

Note - To see a complete list of the icons and their descriptions used in the General Survey software see the [filter table](#).

To view more information on a point do one of the following:

- To reveal all associated points and observations, tap + to expand the point tree list. Expand the subtree to view individual point information. These records can include the point coordinates, observations,

antenna or target details, and quality control records.

- To open the same point form as seen in *Review job*, tap a point, or highlight a point and tap *Details*. This allows you to edit information such as the point code and attributes.

To change the format of the indented coordinates or the observations that appear when you expand the point tree, tap the coordinates or observations displayed, or highlight them and press the space key. In the list that appears, select the new data view.

This allows you to review the raw conventional observations (or WGS-84 observations) and the Grid coordinates at the same time.

Using Grid (local) in the Point manager

You can use Point manager to view Grid (local) coordinates using the input transformation or a display transformation.

To do this:

1. From the main menu, tap *Jobs / Point manager*.
2. Tap *Display* and then select *Grid (local)*.
3. To select the Grid (local) transformation for coordinate display, or to create a transformation, select *Options*.
4. Do one of the following:
 - ◆ To view the original Grid (local) values, select *Display original grid local* and then tap *Accept*.
 - ◆ To create a new display transformation, select *Create new transformation*, tap *Next* and then complete the [required steps](#).
 - ◆ To select an existing display transformation, select *Select transformation*, select the display transformation from the list and then tap *Accept*.

Notes

- ◆ The 'input' transformation transforms a point from the original entered Grid (local) coordinates to database grid coordinates.
The 'display' transformation transforms a point, regardless of how it was stored, from the database grid coordinates to display computed Grid (local) coordinates.
- ◆ When viewing the original Grid (local), points not stored as Grid (local) appear as null North (local), East (local), and Elev (local).
- ◆ When you select a display transformation, all database grid points appear using the current display transformation. If the display transformation is different from the original transformation, the computed Grid (local) coordinates are different from the original entered Grid (local) coordinates.
- ◆ A point entered as a Grid (local) point is stored in its original format to the General Survey job as a Grid (local) point. Typically, the input transformation to transform the point to a database grid point is assigned at the time the point is entered, but the transformation can be created at a later stage and then [assigned](#) to the point(s) using Point manager.

To change the input transformation:

1. From the main menu, tap *Jobs / Point manager*.

2. Tap *Display* and then select *Grid (local)*.
3. Highlight the point(s) stored as *Grid (local)* whose input transformation you need to change.
4. Tap *Edit* and then select *Transformations*.
5. Select the new transformation and then tap *OK*.

The new transformation is now used to transform the *Grid (local)* to database grid.

If the current view showed the original *Grid (local)*, changing the input transformation does not change the *Grid (local)* coordinates displayed.

If the current view showed a different display transformation, changing the input transformation also changes the *Grid (local)* coordinates displayed.

Using Station and offset in the Point manager

You can use Point manager to view points by station and offset relative to an entity such as a Line, Arc, Alignment, Tunnel or Road.

To do this:

1. From the main menu, tap *Jobs / Point manager*.
2. Tap *Display* and then select *Station and offset*.
3. Select *Options*.
4. Select the entity type and the entity name and then tap *Accept*.

Reviewing and editing antenna and target heights

Note - In *Point manager*, the *Target height* setting refers to conventional target heights and the GNSS antenna heights.

To change a target height record and update **all** observations using that target height record, edit the target height in [Review job](#).

To change an individual target height, or group of target heights, in *Point manager*:

1. From the main menu, tap *Jobs / Point manager*.
2. Tap *Display* and then select *Target height*. In the screen that appears, the point name, from point, target height, code, and note are listed in the order they exist in the database.
 - To change the record order, tap the appropriate column heading.
 - To filter the list, tap *Filter*, select the appropriate column and then enter the filter details.

Tip - If you enter a filter value of 2 for a point name, the system will show all points with 2 in their name, including 2, 1002, 2099, or 2day. To filter for a point name "2", select the Match whole word check box.

3. To select a target or multiple targets for editing, do one of the following:
 - Tap the *Target* field.

- Use the arrow keys to highlight the record to edit and then tap *Edit*.
 - To select multiple fields, press and hold *Ctrl* and then tap the required fields. Then tap *Edit*.
 - To select a range of fields, tap the first required field, press and hold *Shift* and then tap the last required field. Then tap *Edit*.
4. In the *Target details* form enter the new *Target height* and/or *Prism constant*. To store the changes, tap *OK*.

When measuring to the bottom notch on a [Trimble prism base](#), tap the advanced pop-up arrow () and then select *Bottom notch*.

Point manager now displays the corrected target details. In *Review job*, view the inserted target records with notes that record the old target details.

Group editing Target heights (conventional) and Antenna heights (GNSS)

You can use the *Point manager* to edit details of antenna heights or target heights for multiple-selected points. This function is available when the *Display* softkey setting in the *Point manager* is set to *Target height*. Use the standard Windows selection methods of *Ctrl-click* and *Shift-click* to choose the points to apply the target or antenna height edits to.

- When you edit antenna heights, you can edit the measured heights and the measurement method.
- When you edit target heights, you can edit the measured target height value, the measurement method (when applicable), and the prism constant.
- When you select points to edit, you can include points with target heights and points with antenna heights. When you tap *Edit*, two dialogs appear - one to edit antenna heights and one to edit target heights.
- You do not need to select contiguous target and/or antenna heights to edit.
- You cannot edit a selection of antenna heights that includes more than one type of antenna. In this case, select and edit the points in separate groups, according to the type of antenna used.
- You can edit a selection of different targets. In such a case, the new target heights are applied to each of the different targets but the target numbers remain unchanged.
- Some conventional measurements use calculated (system) targets, which have a zero height and zero prism constants, for example, Dual-prism offset. You cannot edit the target heights for system targets.
- You can sort *Point manager* columns to help you find and select groups of target or antenna heights to edit. Tap the column heading to sort that column.
- The *Point manager* automatically inserts the appropriate target and antenna equipment records into the job database to ensure that the correct heights and measurement methods are assigned to each point.
- When you edit points, the *Point manager* automatically inserts notes into the job database to record what was edited, the original measurement data, and the time of the edit.

Editing Point Coordinates using Point manager

You can use the *Point manager* to edit the coordinates of imported or keyed in points.

To edit the coordinates of a point:

1. From the main menu, tap *Jobs / Point manager*.
2. To select the record to edit, tap and hold the stylus on the record.
3. Tap *Edit* and then select *Coordinates*.
4. Edit the coordinates and then tap *OK* to save the changes.

You cannot edit the coordinates of:

- raw observations
- points in linked files
- a range of records at one time

A record of the changes made are saved to the *Note* record.

Renaming point names using Point manager

You can use the *Point manager* to edit the names of points and observations.

To rename a point or observation:

1. From the main menu, tap *Jobs / Point manager*.
2. To select the record to edit, tap and hold the stylus on the record.
3. Tap *Edit* and then select *Point names*.
4. Edit the name and then tap *OK* to save the changes.

You cannot edit the name of

- points in linked files
- an observation to the current station if a survey is running
- a backsight observation

A record of the changes made are saved to the *Note* record.

Editing point names and point coordinates in a dynamic database

The General Survey software uses a dynamic database. If you change the name or coordinates of a record, the positions of other records that rely on that record could change or disappear.

The rest of this section describes how changes to a base station position, station setup, or backsight position can affect other positions. In addition to these record types, changes to resections, lines, arcs, compute inverse records, and others may also affect other positions. For more details on specific records that may change, see the table below.

If you rename a point name that is used as a base in a GNSS survey, or as a station setup point in a conventional survey, this does not rename the point name that is referenced in the Base record or Station setup record. You cannot edit the point name referenced in the Base record or Station setup record in any way.

If you rename the base position or station setup position, and another record with the same name **does not** exist, then the positions of all records that are computed from that base position or station setup position

cannot be computed, and those records will no longer be displayed in the map.

If you rename the base position or station setup position, and another record with the same name **does** exist, then the positions of all records that are computed from that base position or station setup position may change, as they will now be computed from the next best point with the same name.

If you edit the base position or station setup position, then the positions of all records that are computed from that base position or station setup position will change.

If you edit the azimuth in an a station setup with a keyed-in azimuth to the backsight, then the positions of all records that are computed from that station setup will change.

If you edit or rename the point record that is used as a backsight in a station setup with a computed azimuth to the backsight, then the positions of all records that are computed from that station setup may change.

If you select a range of records and change their name, all the selected records are renamed to the new name that you entered.

If you rename or edit the coordinates of points, all records that contain computed deltas to other points, for example as-staked, check, and backsight observations, are not updated.

In the following table, the * symbol against a record type shows the dynamic database records that may change if the name or the coordinates of the record that was used to derive their position is modified.

Record	Names	Coordinates
Topo points (GNSS)	*	*
Rapid points	*	*
FastStatic points	*	*
Observed control points	*	*
F1 Topo points (Conv.)	*	*
F2 Topo points (Conv.)	*	*
Mean turned angle	*	*
As-staked points	*	*
Check points	*	*
Continuous points	*	*
Construction points	*	*
Laser points	*	*
Lines	*	*
Arcs	*	*
Compute inverse	*	*
Resection points	-	-
Adjusted points	-	-
Averaged points	-	-
	* 1	* 1

Cogo points (computed) (see note below)		
Intersection points	-	-
Offset points	-	-
Roads	-	-
Alignments	-	-
Tunnels	-	-
Calibration points	-	-
Compute area	-	-

1 - Cogo points can change if the point they are computed from is modified, but it depends on how the Cogo points were stored. If they were stored as a vector, for example Az HD VD and the base point is moved, then the Cogo point will also move.

Adding or editing codes using Point manager

To enter a code or change an existing code, tap the *Code* field. Enter the code details, and the attributes, if required. Tap *Accept* to store the changes.

Group editing codes using Point Manager

You can use the *Point manager* to edit code details for more than one point at a time.

1. Use the standard Windows selection methods; press **Ctrl** or **Shift** and tap the records for which you want to change the code.
2. Tap *Edit* and then select *Codes*.
3. Enter the new code and then tap *Enter*.

If the code has attributes, you are prompted to enter them.

The new codes are updated and displayed in the *Point manager*. A note with the old code value is stored for each modified record.

Tip - You can edit Descriptions in the same way.

Adding or editing notes using Point manager

To enter a note or change an existing note, tap the *Note* field. Enter the note details and then tap *Accept* to store the changes.

Map

The *Map* screen is a graphical representation of features from multiple sources:

- points, lines, and arcs from the current job database

- points from linked jobs and linked CSV files
- points, lines, arcs, polylines, and other map entities from [map files](#) (for example DXF and SHP files)
- alignments defined as .rxl files
- Trimble roads defined as .rxl files

Note - By default, all .rxl files in the current project folder are shown on the map. You can also add .rxl files from any location in the Trimble Data folder.

- surfaces (TTM and LandXML files)
- images from georeferenced background image files. The following image file types and associated world files are supported:

Note - Only Bitmap, JPEG, and PNG files with an associated world file are available for selection.

Tips

- ◆ If you have a Survey-Advanced license, you can export JPEG georeferenced image files from Trimble Business Center using [Image / Capture image]. Trimble Business Center enables large files to be reduced in size for improved performance on the controller.
- ◆ More memory is required to load a BMP file than is required to load a DXF file, and JPEG/PNG files are a compressed format file that requires more memory again when they are uncompressed and loaded into memory.
To compare the memory required to load a BMP file to a DXF file, multiple the BMP file size by four; so a 850 KB BMP file uses 3.4 MB of memory.
To compare the memory required to load a JPEG/PNG file to a DXF file, multiple the JPEG/PNG image height by width multiplied by four; for example if a 130 KB image is 1024 pixels wide by 768 pixels high ($1024 \times 768 \times 4 = 3.14 \text{ MB}$), and so would require 3.14 MB of memory to load the file.

Note - Rotated images are not supported.

Use the following links to learn more about using the map:

- [Accessing the map](#)
- [Using the map softkeys and options](#)
 - ◆ [Zoom previous and zoom default](#)
 - ◆ [Widescreen mode](#)
 - ◆ [Point type filtering](#)
- [Selecting a feature in the map](#)
- [Deselecting a feature in the map](#)
- [Tap and hold shortcut menu](#)
 - ◆ [Current job](#)
 - ◆ [Linked file or Active map](#)
- [Autopan](#)
- [Linked files \(.csv .txt .job\)](#)
 - ◆ [Transferring linked files](#)
 - ◆ [Stakeout points from a linked file](#)
- [Active map](#)

- ◆ [Layers and selectability](#)
- ◆ [Colors in the map](#)
- ◆ [Transferring and selecting maps](#)
- ◆ [Notes on active maps, including supported map entity types](#)

To access the *Map* screen:

1. Tap *Map*. The current position of the GNSS antenna is displayed as a vertical/horizontal cross. The current orientation of a conventional instrument is shown by a dotted line extending from the instrument to the end of the screen. The location of the prism is shown as a cross when a distance is measured.
2. Use the [map softkeys](#) to navigate around the map.

If there is a point with the same name as another point in the database, the point with the higher search class is displayed. For more information about how the General Survey software uses search classes, see [Database search rules](#).

Notes

- Only grid coordinates are displayed. If you have not defined a projection, only points stored as grid coordinates appear.
- [Grid \(local\) coordinates](#) cannot be displayed if the input transformation was not defined.
- If the *Grid coords* field in the [Cogo settings](#) screen is set to Increase South-West or Increase South-East, the map display is rotated by 180° such that increasing south coordinates are displayed up the screen.



Map Softkeys

Use the map softkeys to:

- navigate around the map
- change the map display options

Some softkeys can operate in an "active" mode. The effect of tapping on the map depends on the active softkey selected.

The functions are described in the following table:

Softkey	Function
	Tap this softkey to zoom in. Tap and hold the softkey to make it active. When active, tap the area of the map to zoom in on, or drag to create a box around the area of interest.
	Tap this softkey to zoom out. Tap and hold the softkey to make it active. When active, tap the area of the map to zoom out from.
	Tap this softkey to shift the center of the map area to another part of the map. Tap the softkey to make it active. When active, tap an area of the map to center on, or tap and drag the map area to where you want to pan.

	Tap this softkey to zoom extents and show all features on the screen. Note - The current position of the GNSS antenna is not included unless it is currently being used for GPS search.
---	---

Click the up arrow to access more softkey functions. The additional functions are described in the following table.

<i>Filter</i>	Shows a legend for the feature symbols and linework and lets you choose which features are displayed.
<i>Pan to</i>	Displays the <i>Pan to point</i> screen. Enter a point name and scale value. Tap the <i>Here</i> softkey to pan to the current position.
<i>Options</i>	Controls how name or code labels appear next to points in the map, including the label color.
	Controls the options to display road and alignment station values.
	Controls the option to display elevations in the map.
	Controls the options to display the points symbols for each point.
	Controls the option to display points from the stakeout list in the map. To do this, set the <i>Display stakeout list points</i> field to Yes.
	Controls the Automatic pan to your current position option.
	Controls the option to automatically start a measurement when you press the measure key.
	Controls the option to hatch polygons in a background file.
	Controls the option to display the map in Widescreen mode .
	Controls the option to display surfaces with a color gradient.
	Controls the option to display surface triangles.
Enables a vertical offset to be specified that raises or lowers the surface when viewing from the map.	
<i>Layers</i>	Controls the display of one or more active map files or layers.
	Controls the selectability of one or more active map files or layers.
	Controls the display and selectability of alignment files.
	Controls the display and selectability of Trimble road files.
	Controls the display and stake-ability of digital terrain models.

<i>Filter</i>	Shows a legend for the feature symbols and lets you choose which features are displayed.
<i>Pan to</i>	Displays the <i>Pan to point</i> screen. Enter a point name and scale value. Tap the <i>Here</i> softkey to pan to the current position.
<i>Options</i>	Controls how name or code labels appear next to points in the map.
	Controls the options to display the points symbols for each point.
	Controls the option to display points from the stakeout list in the map. To do this, set the <i>Display stakeout list points</i> field to Yes.
	Controls the Automatic pan to your current position option.
	Tap the automeasure option to automatically start a measurement when you press the measure key.
	Controls the option to display elevations in the map.

<i>Layers</i>	Controls the display of one or more active map files or layers.
---------------	---

To explode polylines into individual line and arc segments, enable the *Explode polylines* check box in *Map / Layers / Options*.

Zoom previous and Zoom default

In the map view, tap and hold the *Map* button in the status bar (or in widescreen mode tap and hold the arrow on the far right side of the map) to display more navigation options:

- Zoom to the previous view
- Zoom to a default scale and location
- Set a default scale and location

Widescreen mode

The map appears in widescreen mode across the entire width of the screen.

To access the status bar while the map is in widescreen mode, tap the arrow on the far right of the map. The status bar appears for approximately three seconds, after which time the map returns to widescreen.

To change the widescreen mode, do one of the following:

- Tap and hold in the map window and then select *Widescreen*
- Tap *Options* within the map screen and then select the *Widescreen* setting
- Press the '.' key on the controller

3D Map

The *Map* screen is a graphical representation of features from multiple sources:

- points, lines, and arcs from the current job database
- points from linked jobs and linked CSV files
- points, lines, arcs, polylines, and other map entities from [map files](#) (for example DXF and SHP files)
- alignments defined as .rxl files
- Trimble roads defined as .rxl files

Note - By default, all .rxl files in the current project folder are shown on the map. You can also add .rxl files from any location in the Trimble Data folder.

- surfaces (DTM, TTM and LandXML files)
- images from georeferenced background image files. The following image file types and associated world files are supported:

Note - Only Bitmap, JPEG, and PNG files with an associated world file are available for selection.

Note - Rotated images are not supported.

Use the following links to learn more about using the map:

- [Accessing the map](#)
- [Using the map softkeys and options](#)
 - ◆ [Zoom previous and zoom default](#)
 - ◆ [Widescreen mode](#)
 - ◆ [Point type filtering](#)
- [Selecting a feature in the map](#)
- [Deselecting a feature in the map](#)
- [Tap and hold shortcut menu](#)
 - ◆ [Current job](#)
 - ◆ [Linked file or Active map](#)
- [Autopan](#)
- [Linked files \(.csv .txt .job\)](#)
 - ◆ [Transferring linked files](#)
 - ◆ [Stakeout points from a linked file](#)
- [Active map](#)
 - ◆ [Layers and selectability](#)
 - ◆ [Colors in the map](#)
 - ◆ [Transferring and selecting maps](#)
 - ◆ [Notes on active maps, including supported map entity types](#)

To access the *Map* screen:

1. Tap *Map*. The current position of the GNSS antenna is displayed as a vertical/horizontal green cross. The current orientation of a conventional instrument is shown by a solid line extending from the instrument to the end of the screen. This line is shown only when the map is in 2D mode. The location of the prism is shown as a red cross when a distance is measured.
2. Tap *Map*. The current position of the GNSS antenna is displayed as a vertical/horizontal cross.
3. Use the [map softkeys](#) to navigate around the map.

If there is a point with the same name as another point in the database, the point with the higher search class is displayed. For more information about how the General Survey software uses search classes, see [Database search rules](#).





Notes

- Only grid coordinates are displayed. If you have not defined a projection, only points stored as grid coordinates appear.
- [Grid \(local\) coordinates](#) cannot be displayed if the input transformation was not defined.
- If the *Grid coords* field in the [Cogo settings](#) screen is set to Increase South-West or Increase South-East, the map display is rotated by 180° such that increasing south coordinates are displayed up the screen.

Map Toolbar

Use the map toolbar to navigate around the map and to change between views.

The functions are described in the following table:

Button	Function
Zoom in 	Tap Zoom in to zoom in. Tap and hold the button to make it active. When active, tap the area of the map to zoom in on, or drag to create a box around the area of interest.
Zoom out 	Tap Zoom out to zoom out. Tap and hold the button to make it active. When active, tap the area of the map to zoom out from, or drag to create a box that the current screen content will fit into.
Pan 	Tap Pan to activate Pan mode. Tap an area of the map to center on, or tap and drag the map area to where you want to pan. If you are using a controller that has arrow keys, you can use the arrow keys to pan even when the map is not in Pan mode.
Zoom extents 	Tap Zoom extents to zoom to the map extents. In 3D the current orientation is kept. Note - The current position of the GNSS antenna is not considered part of the map extents unless it is currently being used for GPS search.

Map Softkeys

Some softkeys can operate in an "active" mode. The effect of tapping on the map depends on the active softkey selected.

The functions are described in the following table:

<i>Filter</i>	Shows a legend for the feature symbols and linework and lets you choose which features are displayed.
<i>Pan to</i>	Displays the <i>Pan to point</i> screen. Enter a point name and scale value. Tap the <i>Here</i> softkey to pan to the current position.
	Controls how name or code labels appear next to points in the map, including the label color. Labels are not displayed for points in DXF, Shape and LandXML files.
	Controls the options to display road and alignment station values.
	Controls the option to display elevations in the map. Elevations are not displayed for points in DXF, Shape, and LandXML files.
	Controls the options to display the points symbols for each point.

	<p>Controls the option to display points from the stakeout list in the map. To do this, set the <i>Display stakeout list points</i> field to Yes.</p> <p>Controls the Automatic pan to your current position option.</p> <p>Controls the option to automatically start a measurement when you press the measure key.</p> <p>Controls the option to hatch polygons in a background file.</p> <p>Controls the option to display the map in Widescreen mode.</p> <p>Controls the option to use the 3D map. Turn off this option to revert to the 2D map. For more information, see Map.</p> <p>Controls the option to display the ground plane. This is shown only when the map is in 3D mode. The ground plane elevation is used as a visual reference when viewing the map in 3D. It is not used in calculations.</p> <p>Controls the option to display surfaces with a color gradient.</p> <p>Controls the option to display surface triangles.</p> <p>Controls the option to display the sides of a surface. Surface sides are shown only when the map is in 3D mode.</p> <p>Enables a vertical offset to be specified that raises or lowers the surface when viewing from the map.</p>	
		Controls the display of one or more active map files or layers.
Controls the selectability of one or more active map files or layers.	<i>Layers</i>	
Controls the display and selectability of alignment files.		
Controls the display and selectability of Trimble road files.		
Controls the display and stake-ability of digital terrain models.		

<i>Filter</i>	Shows a legend for the feature symbols and linework and lets you choose which features are displayed.
---------------	---

<i>Pan to</i>	Displays the <i>Pan to point</i> screen. Enter a point name and scale value. Tap the <i>Here</i> softkey to pan to the current position.
<i>Options</i>	Controls how name or code labels appear next to points in the map.
	Controls the options to display the points symbols for each point.
	Controls the option to display points from the stakeout list in the map. To do this, set the <i>Display stakeout list points</i> field to Yes.
	Controls the Automatic pan to your current position option.
	Tap the automeasure option to automatically start a measurement when you press the measure key.
	Controls the option to display elevations in the map.
<i>Layers</i>	Controls the display of one or more active map files or layers.

To explode polylines into individual line and arc segments, enable the *Explode polylines* check box in *Map / Layers / Options*.

Zoom previous and Zoom default

In the map view, tap and hold the map softkey to display more navigation options:

- Zoom to the previous view
- Zoom to a default scale and location
- Set a default scale and location

Widescreen mode

The map appears in widescreen mode across the entire width of the screen.

To access the status bar while the map is in widescreen mode, tap the arrow on the far right of the map. The status bar appears for approximately three seconds, after which time the map returns to widescreen.

To change the widescreen mode, do one of the following:

- Tap and hold in the map window and then select *Widescreen*
- Tap *Options* within the map screen and then select the *Widescreen* setting

Using the Map for Common Tasks

To select a feature from the map, do one of the following:

- Tap the required feature(s) from the map area. If there is more than one feature in the highlighted area, a list of features in this area appears. Select the features as required and then tap *OK* to return to the map.

Tip - When selecting a line, arc, or polyline to stakeout, tap near the end of the line, arc, or polyline that you want to designate as the start. Arrows are then drawn on the line, arc, or polyline to indicate

the direction.

If the direction of the line, arc or polyline is incorrect, tap the line, arc or polyline to deselect it and then tap it at the correct end to reselect the direction required.

The direction of Alignments and Trimble roads is defined when they are created, and cannot be changed.

Note - The offset directions are not swapped when the line direction is reversed.

- Drag a box around the features you want to select.

When multiple features are selected in this way they are typically sorted in the order in which they are stored in the database. If the order of the entities in the selection is important, you should select them one by one.

To select a feature from a map file, the map file or layers must be made selectable.

To deselect a feature from the map, do one of the following:

- Tap the selected feature to deselect it. If there is more than one feature within the highlighted area, a list of features within this area appears. Deselect the features as required. Tap *OK* to return to the map.
- Tap and hold on the map and select *List selection* from the shortcut menu. A list of the selected features appears. Deselect the features as required.
- To clear the entire selection, double-tap off the selected features. Alternatively, tap and hold on the map and select *Clear selection* from the shortcut menu.

To carry out a task using the selected feature(s), do one of the following:

- Measure
 - ◆ If there are no features selected, tap *Measure* to measure the current position.
 - Tip** - To change the code and/or descriptions when using *Measure* from the map, select a point in the map whose settings you want to be the default, tap and hold on the map briefly and then select *Set point details*.
 - Alternatively, if you want to change default values, but do not want to use the default from an existing point, make sure that there are no features selected before you set point details.
- Stakeout
 - ◆ If one or more features are selected, tap *Stakeout* to stake out the selected feature(s).
If more than one point is selected, the points are added to the *Stake out points* list, from where you can select them for stakeout.
 - ◆ If more than one line or arc is selected, the first item selected is the one used for stakeout.
 - ◆ Double-tap a feature to stake out.
If there is more than one feature within the highlighted area, a list of features within this area appears. Select the feature to stake out.
 - Tip** - If two points are selected, tap and hold on the map and then select *Stake out line* to stake a line defined by the two selected points.

If the selection contains different feature types (points, lines, arcs), only features of the first type selected can be staked out from the map. To stake out other feature types, clear the selection then reselect the other features.

Setting default point details

Tap and hold briefly on the map and then select *Set point details* from the menu.

Use *Set point details* to set the *Next point name*, *Code*, and *Description 1 and Description 2* (if enabled) that will be used as the defaults the next time you measure a point.

If you select a single point in the map when you select *Set point details*, the next available point name, and the code and descriptions of the selected point, become the defaults.

Tap and hold shortcut menu in the map

Tap and hold on the map area to access a shortcut menu. The shortcut menu provides quick access to common tasks. The tasks depend on the number and type of features selected.

In the following table, the * symbol against a task shows that you can access it through the shortcut menu for the feature at the top of that column.

Tap and hold menu options that are available for features in the current job:

Task	Feature					
	No Features	One point	Two points	Three or more points	Line	Arc
Review	-	*	*	*	*	*
List section	-	*	*	*	*	*
Clear section	-	*	*	*	*	*
Widescreen	*	*	*	*	*	*
Delete	-	*	*	*	*	*
Stake out point	-	*	*	*	-	-
Stake out line	-	-	*	-	*	-
Measure calibration point	-	*	-	-	-	-
Navigate to point	-	*	-	-	-	-
Turn to	*	*	-	-	-	-
Compute inverse	-	-	*	*	-	-
Subdivide a line	-	-	-	-	*	-
Key in point	*	-	-	-	-	-
Key in line	-	-	*	-	-	-
Set point details	*	*	-	-	-	-
Check backsight	*	-	-	-	-	-

Check shot	-	*	-	-	-	-
------------	---	---	---	---	---	---

Tap and hold menu options that are available for features in a linked file or active map file:

Task	Feature							
	One active map or linked file point	Two active map or linked file points	Three or more active map or linked file points	Active map line	Active map arc	Active map polyline	Alignment	Trimble road
Review	*	*	*	*	*	*	*	*
List section	*	*	*	*	*	*	*	*
Clear section	*	*	*	*	*	*	*	*
Widescreen	*	*	*	*	*	*	*	*
Delete	-	-	-	-	-	-	-	-
Stake out point	*	*	*	-	-	-	-	-
Stake out line	-	*	-	*	-	-	-	-
Stake out arc	-	-	-	-	*	-	-	-
Create/Stakeout alignment	-	*	*	*	*	*	*	*
Stake out alignment	-	*	*	*	*	*	*	*
Measure calibration point	*	-	-	-	-	-	-	-
Navigate to point	*	-	-	-	-	-	-	-
Turn to	*	-	-	-	-	-	-	-
Compute inverse	-	*	*	-	-	-	-	-
Area calculations	-	-	*	*	*	*	-	-
Subdivide a line	-	-	-	-	-	-	-	-
Subdivide an arc	-	-	-	-	-	-	-	-
Key in point	-	-	-	-	-	-	-	-
Key in line	-	*	-	-	-	-	-	-
Key in arc: 3 points	-	-	*	-	-	-	-	-
Key in arc: 2 points + center	-	-	*	-	-	-	-	-
Set point details	*	-	-	-	-	-	-	-
Check backsight	*	-	-	-	-	-	-	-
Check shot	-	-	-	-	-	-	-	-

Notes

- If you select a point with the same name as another point in the database, then select the *Review* or *Delete* option from the shortcut menu, a list of the duplicate points appears. Select the point you want to review or delete.
- Field fill-in. Enter feature names into fields by selecting from the map. Select the feature(s) from the map then select a survey function, such as Cogo or Stakeout. The selected feature(s) are automatically entered into the appropriate fields.
- Map selection list. The *Map selections option* is available on the right side of the feature name field when you have selected features from the map. Tap it to access the list of the selected features. Only features that are specific to the field are shown.
- You cannot use General Survey to delete points from linked files. Points from linked files do not appear in the *Review* screen list of deleteable points.
- Turn to is available in a conventional survey when a station setup has been completed, and no points are selected. When chosen it turns to the position where the stylus tapped on the screen.
- *Check backsight* and *Check shot* options from the map are available only in conventional surveys.

Selecting points

From the tap and hold menu in the map, use the *Select* option to select points from the current job as well as points in files linked to the current job.

Select from

Use the *Select from* menu to specify where to select the points from. Options are from the Current job, Current job and linked files, or Scan files.

Scan files list any scan files (*.tsf) created in the current job using the Scanning option and the Trimble VX spatial station. You can select multiple scan files.

Notes

- You can select scan files only when the current job has scan data associated with it.
- Use the *Select* softkey to edit the list of selected scan files; use the *Reset* softkey to deselect all scan files.

To select points from the current job or the current job and linked files, define your selection using any combination of the following fields: Point name or Point range, Code, Description 1, Description 2, Minimum elevation, and Maximum elevation.

Notes

- Use the advanced pop-up arrow () to toggle between the Point name field and the point range (From point, To point) fields.
- Use wildcards in these fields to make multiple selections. Use * for multiple characters, and ? for a single character.
- If points are already selected, an *Append to current selection* check box appears on screen. Clear this option if you want to overwrite the current selection.

- Use the *Reset* softkey to clear all selection criteria from the fields.
- Any point selections made in the *Select* screen can be edited in the map view.

Adding points to a list

Method	Description
Enter single point name	Enter a single point name in the current job or linked files.
Select from list	Select from a list of all points in the current job and linked files.
Select using wildcard search	Select from a filtered list of all points in the current job and linked files.
Select from file	Add all points from a defined CSV or TXT file.
All grid points	Add all grid points from the current job.
All keyed in points	Add all keyed in points from the current job.
Points within radius	Add all points within a defined radius from the current job and linked files.
All points	Add all points from the current job, linked files, and any scanned files referenced in the job.
Points with same code	Add all points with a defined code from the current job and linked files.
Points by name range	Add all points within a name range from the current job and linked files.
Section of job	Add all points in chronological order from the first occurrence of "From point" through to and including the first occurrence of "To point".

Notes

- When you add points to the list for stakeout using the *Select from file* option, you can add them from the linked file even if the point in the linked file already exists in the current job. The *Select from file* option is the only way you can [stake a point](#) from a linked file when a point of the same name exists in the current job.
- If a linked job contains two points of the same name, the point with the higher class is displayed.

Units

To configure the Units, tap *Jobs / Properties of job / Units* and change the fields as required.

Tip - In some fields (for example, *Azimuth*), you can enter a value in units other than the system units. The *Units* softkey appears in these fields. When you tap *Enter* to accept the field, the value is converted to the system units.

Use *Units* to configure the display of the following settings:

This setting	Specifies how the following values are displayed
--------------	--

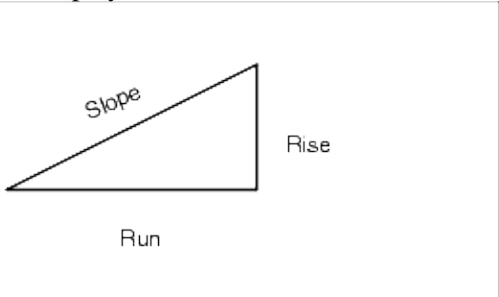
Distance and grid coords	Distance and Northing/Easting coordinates
Height	Height and elevation
Distance display	The number of decimal places in all distance fields
Coordinate display	The number of decimal places in all Northing/Easting coordinate fields
Angles	Angles
Azimuth format	Azimuths
Lat / Long	Latitude and longitude
Temperature	Temperature
Pressure	Pressure
Coordinate order	<p>Coordinates</p> <p>The order for the displayed grid coordinates can be set to:</p> <ul style="list-style-type: none"> - North-East-Elev - East-North-Elev - Y-X-Z (equivalent to East-North-Elev - field prompts changed) - X-Y-Z (equivalent to North-East-Elev - field prompts changed) <p>For the Y-X-Z and X-Y-Z options, the convention used defines that the Y axis is the East axis and the X axis is the North axis.</p>
<p>Station display (also known as Chainage in some countries)</p> <p>This defines the distance along a line, arc, alignment, road or tunnel.</p>	<p>Station</p> <p>The station values can be displayed as either:</p> <ul style="list-style-type: none"> - 1000.0 where the values are displayed as entered - 10+00.0 where the + separates the hundreds from the remaining values - 1+000.0 where the + separates the thousands from the remaining values - <i>Station index</i> <p>The <i>Station index</i> display type uses an extra <i>Station index increment</i> field value as part of its definition. The station value is displayed as per the 10+00.0 option, but the value before the + is the station value divided by the <i>Station index increment</i>. The remainder is displayed after the +. For example if the <i>Station index increment</i> is set to 20, a station value of 42.0 m is displayed as 2 + 02.0 m. This display option is used in Brazil but may have application in other markets.</p>
Grade	<p>Grade</p> <p>The grade of a slope can be displayed as an angle, percent, or ratio.</p> <p>The ratio can be displayed as <i>Rise:Run</i> or <i>Run:Rise</i>.</p> 
Area	<p>Supported area units include:</p> <ul style="list-style-type: none"> - Square meters - Square miles

	<ul style="list-style-type: none"> - Square international feet - Square US survey feet - Acres - Hectares
Laser VA display	Laser Vertical angles Can be vertical angles measured from the zenith, or inclinations measured from horizontal.
Time format	Time

Cogo Settings

To configure the Cogo settings, tap *Settings* from the Trimble Access menu and then select *Units Cogo / Cogo settings*.

To configure the Cogo settings, tap *Job / New job / Cogo settings* when creating a new job. For an existing job tap *Job / Properties of job / Cogo settings*.

Use *Cogo settings* to configure:

- [Distance display](#) (grid, ground, or ellipsoid)
- [Sea level \(ellipsoid\) correction](#)
- [Increasing grid coordinate direction](#)
- [South azimuth](#)
- [Neighborhood adjustment and weight exponent](#)
- [Magnetic declination](#)
- [Advanced Geodetic](#)
- [Averaging](#)

Distance Display

The *Distances* field defines how distances are displayed and which distances are used for calculations in the General Survey software. Select one of the following options:

- Ground (the default setting)
- Ellipsoid
- Grid

The following diagram shows the options between points A and B.

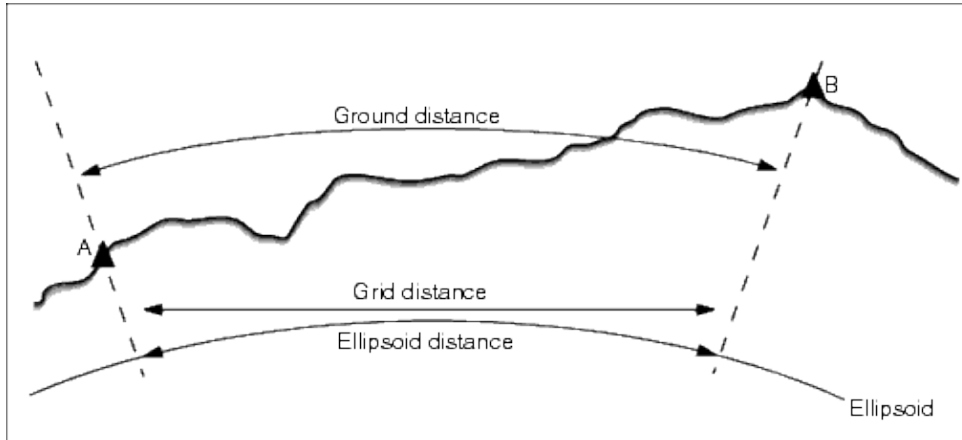

Ground distance

A ground distance is the horizontal distance calculated between the two points at the mean elevation parallel to the chosen ellipsoid.

If an ellipsoid has been defined in the job and the *Distances* field is set to *Ground*, the distance is calculated parallel to that. If no ellipsoid has been defined, the WGS84 ellipsoid is used.

Ellipsoid distance

If the *Distances* field is set to *Ellipsoid* then a correction is applied and all distances are calculated as if on the local ellipsoid, which usually approximates to sea level. If no ellipsoid has been specified, the WGS84 ellipsoid is used.

Note - If the coordinate system for a job is defined as *Scale factor only*, ellipsoid distances cannot be displayed.

Grid distance

If the *Distances* field is set to *Grid*, the grid distance between two points is displayed. This is the simple trigonometrically distance between the two sets of two-dimensional coordinates. If the coordinate system for the job is defined as *Scale factor only*, and the *Distances* field is set to *Grid*, the General Survey software displays ground distances multiplied by the scale factor.

Note - A grid distance between two measured GNSS points cannot be displayed unless you have specified a datum transformation and a projection, or performed a site calibration.

When you select *Scale factor only* in a conventional instrument only survey, grid and ground distances can be displayed.

Curvature Correction

In the General Survey system, all ellipsoid and ground distances are parallel to the ellipsoid.

Sea level (ellipsoid) correction

The *Sea level (ellipsoid) correction* check box enables you to choose whether or not the horizontal components of distances measured with a conventional total station should be corrected to their equivalent length on the ellipsoid.

In most case, select the *Sea level (ellipsoid) correction* check box to compute the correct geodetic grid coordinates from the total station observations.

However, if the local ellipsoid was inflated to provide computed ground coordinates, but the point heights were not changed to be in terms of the inflated ellipsoid, do not select sea level correction; for example, when using jobs with Minnesota county coordinate systems.

The sea level correction is carried out using the average height (not elevation) of the line above the local ellipsoid. If both ends of the line have null heights, the default height specified for the job is used to compute this correction.

The formula used for the computation is:

$$\text{Ellipsoid horizontal distance} = \text{HzDist} \times \text{Radius} / (\text{Radius} + \text{AvHt})$$

HzDist	Horizontal component of measured distance
Radius	Ellipsoid semi-major axis
AvHt	Average height above local ellipsoid of the measured line

Notes

- In jobs where the coordinate system is configured to provide ground coordinates, the *Sea level (ellipsoid) correction* is always enabled and cannot be edited. This is because the sea level correction is already applied in the computation of the ground coordinates.
- In a Scale only job, there is no local ellipsoid available because this is not a geodetic projection. In this case, the correction computation defaults to using the semi-major axis of the WGS84 ellipsoid (6378137.0 m) as the radius value. The sea level correction in Scale only jobs also uses the point elevations because there are no ellipsoidal heights available.
- You cannot set a default height for Scale only jobs. This means that if the *Sea level (ellipsoid) correction* is enabled in a Scale only job, you must use 3D points, or null coordinates will be computed because it is not possible to compute the sea level correction.

Grid Coordinates

Use the *Grid coords* field to set the grid coordinates to increase in one of the following sets of directions:

- north and east
- south and west
- north and west
- south and east

The following diagram shows the effect of each setting.

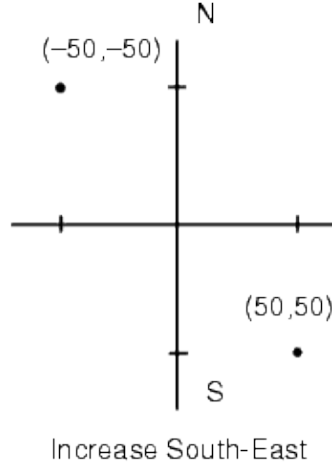
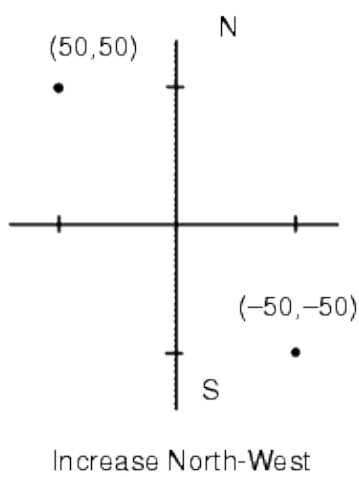
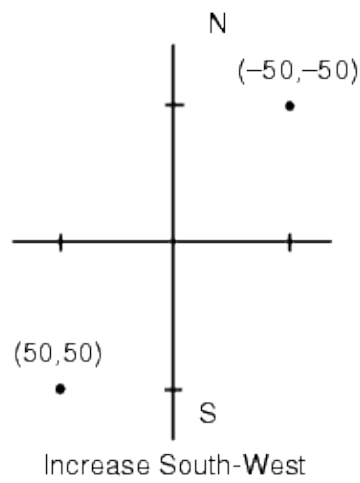
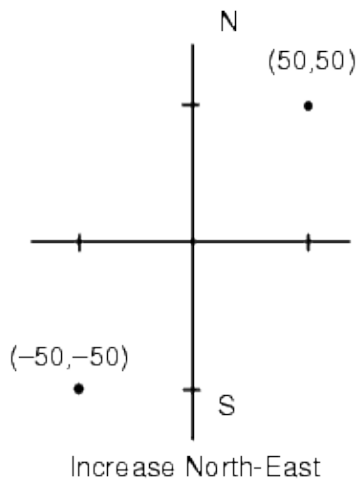

Azimuth Display

The azimuth displayed and used by the General Survey software depends on the coordinate system that you defined for the current job:

- If you defined both a datum transformation and a projection, or if you selected *Scale factor only*, the grid azimuth is displayed.
- If you defined both a datum transformation and a projection, the grid azimuth is displayed.
- If you defined no datum transformation and/or no projection, the best available azimuth is displayed. A grid azimuth is the first choice, then a local ellipsoidal azimuth, then the WGS84 ellipsoid azimuth.
- If you are using a laser rangefinder, the magnetic azimuth is displayed.

If a south azimuth display is required, set the *South azimuth* field to *Yes*. All azimuths still increase clockwise. The following diagram shows the effect of setting the *South azimuth* fields to No or Yes.

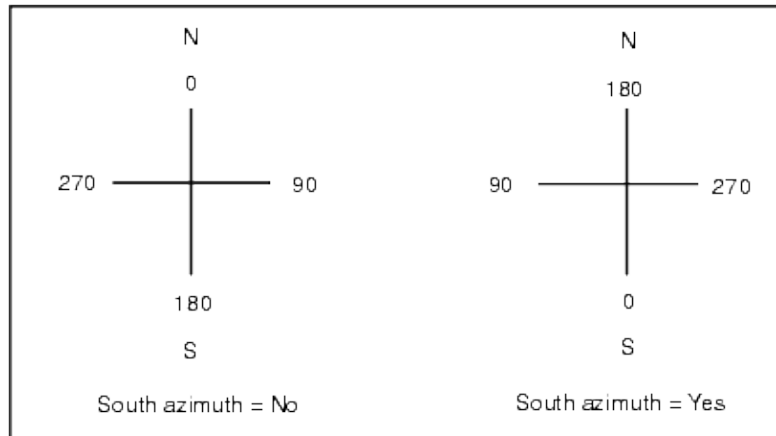

Neighborhood adjustment

You can apply a *Neighborhood adjustment* to all conventional foresight observations made from a Station setup plus or Resection, and to all GPS observations made in a job that has a valid GPS site calibration. To apply Neighborhood adjustment, select the check box in *Properties of job / Cogo settings*.

Neighborhood adjustment uses the residuals from *Station setup plus*, *Resection* or *GNSS site calibration* to calculate delta grid values to apply to subsequent observations made during the survey. Each observation is adjusted according to its distance from each of the backsight points (for a conventional survey) or calibration points (for a GNSS survey). The following formula is used to calculate the weight to give the residuals of each backsight or calibration point:

$$p = 1/D^n \text{ where:}$$

- p is the weight of the backsight or calibration point
- D is the distance to the backsight or calibration point
- n is the weight exponent

A weighted average is then computed and the resulting delta values are applied to each new observation to get an adjusted grid position.

Note - A high value for the weight exponent results in low impact (weight) of distant backsight or calibration points.

For *Neighborhood adjustment* to be applied, the station setup or calibration must have at least 3 known points with 2D grid residuals. That is, if you perform a:

- Station setup plus, you must have HA VA SD observations to at least 2 backsight points, each with known 2D coordinates.
- Resection, you must have HA VA SD observations to at least 3 backsight points, each with known 2D coordinates.
- Calibration, you must have GNSS observations to at least 3 control points, each with known 2D coordinates.

Notes

- Neighborhood adjustment will use a *GNSS site calibration* only if it has been observed in the current General Survey job. This is because a GNSS calibration that is part of the coordinate system in an uploaded job does not include the GNSS calibration residuals.
- For *Station setup plus*, the known station coordinate is included in the neighborhood adjustment calculation. In the calculation, the station coordinate is given grid residuals of zero.
- Neighborhood adjustment is a 2D-only adjustment. Any vertical residuals from station setup or calibration are not used in the neighborhood adjustment calculations.
- Neighborhood adjustment using GNSS site calibration residuals is applied to all WGS84 points in the job, not just GNSS observations.

Warning - Make sure that the backsight or calibration points are around the perimeter of the site. Do not survey outside the area enclosed by the backsight or calibration points (and for Station setup plus, the station point). The neighborhood adjustment is not valid beyond this perimeter.

Magnetic Declination

Set the magnetic declination for the local area if magnetic bearings are being used in the General Survey software. You can use magnetic bearings if you choose the *Cogo / Compute* point using the Brng-dist from a point method.

The magnetic declination defines the relationship between magnetic north and grid north for the job. Enter a negative value if magnetic north is west of grid north. Enter a positive value if magnetic north is east of grid north. For example, if the compass needle points 7° to the east of grid north, the declination is $+7^\circ$ or 7°E .

Note - Use the published declination values if available.

Note - If grid north in the job has been rotated away from true north due to the coordinate system definition (possibly via a GNSS calibration) then this must be allowed for in the magnetic declination specified.

Advanced Geodetic

Select *Advanced Geodetic* to enable the following options:

- **Station setup scale factor**
- **Helmert transformation for Resection**
- **Local transformations**
- **SnakeGrid**

Averaging

The *Averaging* field defines how duplicate points are averaged. Select one of the following options:

- Weighted
- Unweighted

Auto Stakeout - points and lines

- ◆ Use lines to define and auto stake the following Mines features:
 - ◇ Center and Grade lines
 - ◇ Laser lines
 - ◇ Blast holes
- ◆ And use points to define and auto stake:
 - ◇ Pivot points

Additional Settings

To configure the Additional settings, tap *Job / New job / Additional settings* when creating a new job. For an existing job tap *Job / Properties of job / Additional settings*.

Add to CSV File

You can choose to add points measured using *Measure topo* or *Measure rounds* to a CSV file. To do this:

1. Select the *Enable* option.
2. In the *CSV file name* field, enter a file name or use the folder button to select a file. By default, the CSV file is stored in the current user folder.

Tip - This option can be used to create a file of control points.

Export Custom Format Files

Import Custom Format Files

Use this menu to import custom ASCII files into your current job. You can use the predefined formats or create your own custom format to import fixed-width or delimited ASCII files. You can import the following data using this option:

- Point name
- Code
- Description 1 and Description 2
- Notes attached to points
- Grid coordinates
- WGS84 geographic coordinates (degrees minutes and seconds, or decimal degrees)
To be successfully imported, points must have a height.
- Local geographic coordinates (degrees minutes and seconds, or decimal degrees)
To be successfully imported, points must have a height
- Line definitions
Before you import, line start and end points must exist in the database.

Line definitions include the following information: start point name, end point name, start station, station interval, azimuth, and length.

The predefined ASCII import formats available in the controller include:

- CSV Grid points E-N
Point Name, Easting, Northing, Elevation, Code
- CSV Grid points N-E
Point Name, Northing, Easting, Elevation, Code
- CSV Lines
Start Point Name, End Point Name, Start Station, Station Interval
- CSV WGS-84 Lat-long points
Point Name, Latitude, Longitude Height, Code

These Custom Import ASCII formats are defined by .ixl import definition files that are stored in the [System files] folder.

To import an ASCII file using a predefined file format:

1. Transfer the file to be imported into your data folder on your controller.
 2. Open or create the job that you want to import the data into.
 3. From the main menu, select *Jobs / Import*.
 4. In the *File format* field, specify the type of file to import.
 5. Tap  to select an existing folder or create a new one.
 6. In the *File name* field, select the file to import. All files in your data folder with the file extension specified in the format file (by default CSV) appear in the list.
 7. If you are importing points, select or clear, as required, the *Import points as control* check box to specify if the imported points should be control points.
 8. To import the file, tap *Accept*.
- After import, a summary box shows how many items were imported and how many were discarded.

Creating custom ASCII import format files

Custom ASCII import format files are stored on the controller in the [System files] folder, with the extension *.ixl. You can make simple edits to existing format files on the controller using Microsoft Pocket Word software. If you have majors edits or you want to create new format files, use a text editor on a desktop computer.

For information on how to create your own import formats, refer to the Import Custom Format Files document available from www.trimble.com.

Survey - General

Measure Codes

To measure and code Conventional or GNSS observations in one step, select the feature code you want to measure and store from a coding form containing a number of configurable buttons. You can define multiple groups or pages of codes, each consisting of up to 25 codes.

In the *Measure codes* form, if you activate the *Code* button, it affects the behavior of the configurable code buttons. When you then tap one of the configurable code buttons, the code on that button is added to the code field at the bottom of the *Measure codes* form. Typically, you can use the *Code* button to combine codes from multiple code buttons where features combine, either from the current group, or a combination of groups. You can also use it to enter a new code.

If a code has attributes, the attribute values appear at the bottom of the *Measure codes* form. You cannot directly edit these attribute values in the form. To change the attribute values, do one of the following:

- Tap *Attrib* in the *Measure codes* form.
- Tap *Attrib* in the *Measure topo/Measure points* form.
- If *Prompt for attributes* is enabled, enter the attributes when prompted.
 - ◆ If you pre-entered attributes using the *Attrib* softkey, you are not prompted for attributes.

For more information, see [Using Feature Codes with Predefined Attributes](#).

To add a feature code group and assign codes to the buttons:

1. Select *Measure / Measure codes* and then tap *Add group*.
2. Enter a *Group name* and then tap *OK*.
3. To add a code to a button:
 - ◆ Tap and hold on the button. When the tooltip message appears, remove the stylus from the screen. In the dialog that appears, enter the code, or select a code from the feature code library.
 - ◆ Navigate to the button using the arrow keys, and then press the Space key, which emulates the 'tap and hold' action.

In the dialog that appears, enter the code, or select a code from the feature code library. Tap *OK*. The code you entered now appears on the button.

If required, you can also enter additional [descriptions](#).

4. To add another code, or remove a code from a button, repeat Step 3.
5. To add more groups of feature code buttons, tap *Add group*.

To navigate to a particular group, select it from the drop down list in the top left of the form. Alternatively, use A - Z to quickly switch to group pages 1 - 26. This method is not available if the *Code* button is enabled.

To measure and code observations using Measure codes:

1. Select *Measure / Measure codes*.
2. To initiate a measurement, activate the button using one of the following methods:
 - ◆ Tap the button.
 - ◆ Press the numeric key on the controller keyboard corresponding to the button. Keys 7, 8, 9, activate the top row of buttons, keys 4, 5, 6 activate the middle row of buttons, keys 1, 2, 3 activate the bottom row of buttons.
 - ◆ Use the arrows keys on the controller to navigate to the button and then press **Enter**.

If the code has attributes, the attribute values appear at the bottom of the *Measure codes* form.

3. To automatically start the measurement when the button is selected, tap *Options* and then select the *Auto measure* check box.

Note - When the method is set to *Distance offset*, *Angles only*, and *H Angle only*, *Automeasure* is temporarily paused.

4. To configure the position of the highlight for the next code, tap *Options* and then configure the *Direction* of the *Template pickup*.
5. The code field is set to the code on the button and the measurement is initiated. The measurement is automatically stored depending on the setting in *Options*:
 - ◆ In a Conventional survey, clear the *View before storage* check box in the *Measure point options* form.

If descriptions were defined on the Measure codes button, the descriptions are also set to the descriptions on the button.

6. Once you store the measurement, the *Measure codes* form appears, ready for the next measurement.

Tap [Enter] to measure a point with the same code again, or use one of the methods described in step 2 above to measure with a different code.

The *Measure topo/Measure points* form, where the measurement was initiated, remains open in the background. If you need to change the point name or measurement method, tap *Switch to* to switch to this form, change the fields as required and then tap *Switch to* again to return to the *Measure codes* form.

Using Template pickup

Use the *Template pickup* feature to automatically move the highlight from the current button to the next button after storing a measurement. Template pickup is particularly useful when coding observations in a regular pattern, for example, across a road template.

To configure template pickup, tap *Options* and then configure:

- The template pickup *Direction*. Refer to the following diagram:
 - ◆ Left to right - The highlight moves from 7-9, then 4-6, then 1-3.
 - ◆ Right to left - The highlight moves from 3-1, then 6-4, then 9-7.

- ◆ Zig zag - The highlight moves from 7-9, 4-6, 1-3 then 3-1, 6-4, 9-7, then 7-9 and so on.

To skip a code, tap a different button, or use the arrow keys to select an alternative code button.

- The *Number of elements*:
 - ◆ The *Number of elements* configured should match the number of elements across the template, and the number of buttons configured in Measure codes.

Notes

- The first time that you use *Measure codes*, the measurement may not begin automatically if you have not defined the point name and target height. If this occurs, complete these fields and then tap *Measure* to begin the measurement.
- To change target or antenna heights, tap the target icon in the status bar.
- During a measurement, you can change the point name, and the target or antenna height and code. However, you can do this only if you start editing before the observation is stored. Alternatively, tap *Esc* as soon as the measurement begins, make the required changes, then tap *Measure* to restart the measurement.
- To change the EDM or measurement method, tap *Esc* during the measurement, make the required changes, then tap *Measure* to restart the measurement.
- To change the point name or measurement method before you start a measurement, tap *Switch to* to switch to the *Measure topo/Measure points* form, change the fields as required and then tap *Switch to* again to return to the *Measure codes* form.
- To measure a point with a null code, activate a blank code button. Alternatively, tap *Code*, ensure that the code field is empty and then tap *Measure*.
- To store a **note** with an observation, tap .
- To delete an entire group of codes, select the group and then tap *Delete*.

Template pickup with multiple groups

Stringing support

Measure codes has '+' and '-' softkeys that enable you to apply a suffix to the code on the button. This is useful when you use the stringing method for feature coding.

You can configure the suffix to 1, 01, 001, or 0001.

When the suffix is configured to 01, tap '+' to increase the code "Fence" to "Fence01". Tap '-' to decrease the code by 01.

Tap *Find* to find the next available string for the currently highlighted button.

Attributes and Base codes

You can configure the General Survey software to provide attributes for the complete code, or from a portion of the code - the "base code".

Typically, base codes are used when you use the '+' and '-' softkeys to "string" feature codes. For example, when you code a fence where all observations coded "Fence01" are joined together and all observations coded "Fence02" are joined together, and so on, and they all have the same attributes. In this example, you can create feature code libraries that contain all the "Fence**" codes, or contain just the base code "Fence".

If you do not string codes, or if you do string codes but you include the entire code in the feature code library, then you are not using base codes. Disable *Use attributes of base code* (clear the check box).

If you do string codes, and the feature library includes only the base code, then enable *Use attributes of base code* (select the check box).

In the General Survey software, you can use the extra power of Measure codes to create a button that contains a numeric or alpha-numeric code (the base code) and then append a numeric suffix using the '+' or '-' softkeys. For codes entered into any other code field in the General Survey software, you cannot use the '+' or '-' softkeys to append a suffix, so when you use base codes, the software can only attempt to determine the base code by stripping the numeric characters from the end of the codes.

The following rules help to explain the base code:

- **In Measure codes:**

1. When *Use attributes of base code* is disabled, the code displayed on a button is the base code.
◇ Enter "Fence", string the code to become "Fence01", the attributes are derived from "Fence01".
2. When *Use attributes of base code* is enabled, the code entered on a button is the base code.
◇ Enter "Fence", string the code to become "Fence01", the attributes are derived from "Fence".
3. If you edit or change the code on a button, the base code resets, using rule 1 or rule 2 above.
4. If you change the configuration of the *Use attributes of base code* setting, the base code resets, using rule 1 or rule 2 above.
5. When Measure codes 'passes' the code to the Measure topo, or Measure points system, the base code from within Measure codes is retained.

- **In any other code field** of the General Survey software:

1. When *Use attributes of base code* is disabled, the code entered is the base code.
2. When *Use attributes of base code* is enabled, the base code is determined by 'internally' stripping any numeric characters from the end of the code.
3. When *Use attributes of base code* is enabled, and you edit a code that is 'passed' from Measure codes, the base code is re-derived by 'internally' stripping any numeric characters from the end of the code.

Notes

- If you use attributes and numeric codes with a string suffix, you must use Measure codes to define the suffix and start the measurement. Measure codes understands where the code ends and the suffix starts. If you do not use Measure codes, the entire numeric code + suffix will be treated as the code, the suffix cannot be determined, and attributes for the base code will not be available.
- To configure *Use attributes of base code*, from within Measure codes, use the up arrow softkey to select *Options*, and then select the check box as required.

- The *Use attributes of base code* setting is configured within Measure codes, but is applied throughout the General Survey software.
- If you edit the code on a button when *Use attributes of base code* is disabled, the entire code from the code button is displayed in the Edit field.
- If you edit the code on a button when *Use attributes of base code* is enabled, the base code is displayed in the Edit field.
 - ◆ The code on the button is "Fence01" and the base code is "Fence". If you edit this code, the base code "Fence" is displayed.
- You can string alphanumeric codes when *Use attributes of base code* is disabled. The code displayed on the button is the base code.
- You cannot string numeric only codes when *Use attributes of base code* disabled.

Tip - If you use multiple codes with attributes, enter all the codes **before** you enter the attributes.

Sharing Measure codes groups between controllers

The groups, and the codes within each group, are stored in a Measure Codes Database file (*.mcd).

If you use a feature library, the Measure Codes Database file (*.mcd) is tied to that feature library and has a matching name. If you use the same feature library on other controllers, you can copy the *.mcd file to use in the other controllers. To use the feature library *.mcd file, you must assign the feature library to the job.

If you do not use a feature library, a [Default.mcd] file is created. The [Default.mcd] file can also be copied to other controllers. When the General Survey software does not have a feature library assigned to a job, the [Default.mcd] file is used in *Measure codes*.

Conventional Survey - Setup

Conventional Survey: Getting Started

The process for completing measurements using a conventional instrument is described below. Click each link to view more information.

1. [Configure your survey style](#) if required
2. [Prepare for a robotic survey](#)
3. [Perform a station setup](#) , [station setup plus](#) , [resection](#) or [refline](#)
4. [Begin the survey](#)
5. [Measure points](#)
6. [End the survey](#)

Configuring Conventional Survey Styles

All surveys in General Survey are controlled by a Survey Style. Survey Styles define the parameters for configuring and communicating with your instruments, and for measuring and storing points. This whole set of information is stored as a template and used each time you start a survey.

General Survey automatically connects to Trimble instruments. Configure the style only if the defaults do not suit your needs.

To configure a survey style:

1. From the Trimble Access menu, tap *Settings / Survey styles / <Style name>*.
2. Select each of the options in turn, and set them to suit your equipment and survey preferences.
3. Once you configure all the settings, tap *Store* to save them, and then tap *Esc* to return to the main menu.

Configure Topo Point Settings

A topo point is a previously configured method of measuring and storing a point. Configure this type of point when you create or edit a Survey Style.

To configure the survey style, from the Trimble Access menu, tap *Settings / Survey styles / Topo point*.

Use the *Measure display* field to configure how the observations are displayed on the controller.

Use the *Auto point step size* field to set the increment size for automatic point numbering. The default is *1*, but you can use larger step sizes and negative steps.

Select the *View before storage* check box to view observations before they are stored.

Preparing for a Robotic Survey

If the instrument is level, has the correct radio settings, and you are using the autocentered search window, press the trigger button to turn on the instrument for a robotic survey.

To configure the Radio channel and Network ID on a Trimble VX Spatial Station or Trimble S Series total station without using the General Survey software, select [Radio settings] on the instrument through the *Face 2* menu display.

For more information, refer to the documentation for your instrument.

Note - General Survey cannot communicate with the Trimble VX Spatial Station or Trimble S Series total station when the onboard programs are in use. Once you finish using the instrument's onboard programs, select [Exit] from the [Setup] menu to return to the [Waiting for connection] menu.

The following section describes how to level the instrument, configure the radio settings, and set the search window on the instrument through the Trimble CU controller.

Preparing the Trimble VX Spatial Station or Trimble S Series total station for a Robotic survey

1. With the Trimble CU attached to the Trimble VX Spatial Station or Trimble S Series total station, press the trigger button to turn on the instrument and controller.
2. Start the General Survey software, level the instrument and then tap *Accept* in the leveling screen. Tap *Esc* to exit the *Corrections* screen and the *Survey Basic* screen if they appear.
3. From the Trimble Access menu, tap *Settings / Connect / Radio settings*.
4. Set the *Radio channel* and *Network ID* and then tap *Accept*.
5. Do one of the following:
 - To set a search window:
 - a. From the main menu, select *Measure / Start robotic*.
 - b. Select *Define now* and tap *OK*.
 - c. Aim the instrument to the Top left corner of the search window and tap *OK*.
 - d. Aim the instrument to the Bottom right corner of the search window and tap *OK*.
 - e. Tap *OK* to suspend the controller ready for robotic operation.
 - If you plan to use an [Autocentered search window](#), press the power key on the Trimble CU to suspend the controller.
You do not need to define the search window now.
6. Remove the controller from the instrument and attach it to the robotic holder.
7. Press the power key on the Trimble CU. The General Survey software auto-connects to the instrument radio and displays the leveling screen. If required, level the instrument and tap *Accept*.

You are now ready to perform a station setup.

Station Setup

In a conventional survey, you must complete a station setup to orientate the instrument.

1. From the main menu, select *Measure* / *<Style name>* / *Station setup*.

The menu that appears varies according to whether or not you have a current station setup.

Note - If you have only one style, it is automatically selected.

2. Set the **corrections** associated with the instrument.

If the *Corrections* form does not appear, tap *Options* from the *Station setup* screen to set the corrections.

To make the *Corrections* form appear on startup, select the *Show corrections on startup* option.

3. Enter the instrument point name and the instrument height. If the point is not already in the database, you can key it in or leave it as null.

When measuring to the bottom notch on a Trimble VX Spatial Station or Trimble S Series total station, tap the advanced pop-up arrow () and then select *Bottom notch*. Enter the height measured to the top ridge of the bottom notch on the instrument.

General Survey corrects this measured slope value to true vertical and adds the offset 0.158 m (0.518 sft) to calculate true vertical to the trunnion axis.

Note - If you select *Bottom notch*, the minimum slope distance (Hm) that you can enter is 0.300 meters. This is approximately the minimum slope distance that can be physically measured. If this minimum is too low, you must measure to the top mark.

For details, see the following figure and table.

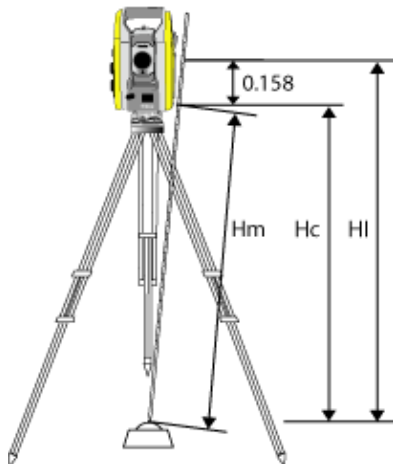

0.158m	Offset from bottom notch to trunnion axis.
--------	--

Hm	Measured slope distance.
Hc	Hm corrected from slope to true vertical.
HI	Hc + 0.158m. True vertical instrument height.

Notes

- ◆ If the coordinates for the instrument point are not known, perform a [resection](#) to known points to coordinate the point.
- ◆ For a 2D or planimetric survey, leave the *Instrument height* field set to null (?). No elevations are calculated. Unless you are using a Scale only projection, a project height must be defined in the coordinate system definition. General Survey software needs this information to reduce measured ground distances to ellipsoid distances and to compute 2D coordinates.

4. Enter the backsight point name and the target height. If there are no coordinates for the point, you can key in an azimuth.

When measuring to the bottom notch on a [Trimble prism base](#), tap the advanced pop-up arrow () and then select *Bottom notch*.

Notes

- ◆ If you do not know the azimuth, you can enter an arbitrary value and then edit the azimuth record later, in review.
- ◆ If you cannot determine the coordinates for the instrument or backsight point, you can key them in or measure them later using GNSS (provided that there is a valid GNSS site calibration). The coordinates of any points measured from that station are then computed.
- ◆ When you enter the instrument point later, make sure that you choose to overwrite the original instrument point in the *Duplicate point* form. The coordinates of any points measured from that station are then computed.
- ◆ You can use the Point manager to edit the coordinates of the instrument point. If you do, then the positions of all records that are computed from that station setup position may change.
- ◆ You can use Point manager to edit the coordinates of the backsight point. If you edit the point record that is used as a backsight in a station setup with a computed azimuth to the backsight, then the positions of all records that are computed from that station setup may change.

Tip - If the point is available from a linked file, select the linked file for the job and then enter the point name in the *Instrument point name* or *Backsight point name* field. The point is automatically copied to the job.

5. Choose an option in the *Method* field. The options are:
 - ◆ Angles and distance - measure horizontal and vertical angles and slope distance
 - ◆ Averaged observations - measure horizontal and vertical angles and slope distance for a predefined number of observations
 - ◆ Angles only - measure horizontal and vertical angles
 - ◆ H. Angle only - measure horizontal angle only
 - ◆ Angle offset - measure the slope distance first, the instrument can then be repointed and then measure the horizontal and vertical angles

- ◆ H. Angle offset - measure the vertical angle and slope distance first, the instrument can then be repointed and then measure the horizontal angle
 - ◆ V. Angle offset - measure the horizontal angle and slope distance first, the instrument can then be repointed and then measure the vertical angle
 - ◆ Distance offset - enter the left/right, in/out or V.Dist offset from the target to the object when a point is inaccessible and then measure horizontal and vertical angles and slope distance to the offset object
- When you use an offset method, tap *Options* and then set the *Offset & Stakeout directions* perspective.

Tip - When using Autolock technology and measuring offset points, select the *Autolock off for offsets* check box. When enabled, Autolock technology is automatically disabled for the offset measurement and then re-enabled after the measurement.

6. Sight the center of the backsight target and then tap *Measure*.

Select the *View before storage* check box to view observations before they are stored.

7. If Auto F1/F2 is enabled:

- a. Tap *Store* to store the F1 observation. The instrument changes face.
- b. Sight the center of the backsight target and then tap *Measure*.

8. If the residuals for the station setup are acceptable, tap *Store*.

Tip - To change the display, tap the view display button on the left of the measurement information.

Note - The residuals are the differences between the known position and the observed position of the backsight point.

Station setup is complete.

Note - If you want to measure more than one backsight point, use [Station setup plus](#).

For more information, see:

[Station setup plus](#)

[Resection](#)

[Advanced Geodetics support](#)

Station setup plus

In a conventional survey, use *Station setup plus* to perform a station setup on a known point by making observations to one or more backsight points.

Warning - If the station setup point is a traverse station that you plan to adjust, **do not** measure more than

one backsight point. Clear the *Backsight* check box for any additional points so that they are measured as foresights.

For more details, see:

[Performing a Station setup plus](#)

[Station setup - Residuals screen](#)

[Skipping observations](#)

[Point - Residuals screen](#)

[Point details screen](#)

[Station setup results screen](#)

Performing a Station setup plus

To perform a Station setup plus:

1. From the main menu, select *Measure* / *<Style name>* / *Station setup plus*.
2. Set the [corrections](#) associated with the instrument.

If the *Corrections* form does not appear, tap *Options* and then select the *Show corrections on startup* check box.

3. Enter the instrument point name. If the point is not already in the database, key it in or leave it as null.

If the coordinates for the instrument point are not known, perform a [Resection](#) to known points. This will provide the coordinates.

4. If applicable, enter the instrument height and then tap *Accept*.

When measuring to the bottom notch on a Trimble VX Spatial Station or Trimble S Series total station, tap the advanced pop-up arrow () and then select *Bottom notch*. Enter the height measured to the top ridge of the bottom notch on the instrument.

General Survey corrects this measured slope value to true vertical and adds the offset 0.158 m (0.518 sft) to calculate true vertical to the trunnion axis.

Note - If you select *Bottom notch*, the minimum slope distance (Hm) that you can enter is 0.300 meters. This is approximately the minimum slope distance that can be physically measured. If this minimum is too low, you must measure to the top mark.

- For a 2D or planimetric survey, leave the *Instrument height* field set to null (?). No elevations is calculated.
- Once the station setup is started, you cannot enter a different instrument height.

Warning - Before you continue, tap *Options* and make sure that the *Face order* setting is correct. You cannot change this setting after you start measuring points.

5. Enter the first backsight point name and the target height, if applicable. If there are no coordinates for the point, you can key in an azimuth.

When measuring to the bottom notch on a [Trimble prism base](#), tap the advanced pop-up arrow () and then select *Bottom notch*.

If the point is available from a linked file, select the linked file for the job and then enter the point name in the *Instrument point* name or *Backsight point name* field. The point is automatically copied to the job.

Note - To include foresight points during Station setup plus, clear the *Backsight* check box. Foresight points do not contribute to the station setup result.

6. Choose an option in the *Method* field.
7. Sight the target and then tap *Measure*.

The *Station setup residuals* screen appears.

See the following sections for more information on what do next.

Skipping observations

When using *Automate rounds* you can configure the software to automatically skip obstructed foresight targets.

If the instrument cannot measure the point and *Skip obstructed foresights* is **enabled**, it skips that point and moves onto the next point in the rounds list.

If the instrument cannot measure the point and *Skip obstructed foresights* is **disabled**, a message appears after 60 seconds to indicate that the prism is obstructed.

The General Survey software continues to try to measure to the target until instructed to skip the point. To do this, tap *Ok* for the obstructed prism message, tap *Pause* and then tap *Skip*.

When the General Survey software reaches the end of a rounds list in which points have been skipped, the following message appears:

Observe skipped points?

Tap *Yes* to observe the points that were skipped during that round. The observations can be skipped again if required. Tap *No* to end the round.

If a point is skipped in one round, all subsequent rounds continue to prompt for observations to that point.

When one observation from a pair of face 1 and face 2 observations has been skipped, the unused observation is automatically deleted by the General Survey software. Deleted observations are stored in the General

Survey database and can be undeleted. Undeleted observations can be processed in the office software, but are not automatically used to recompute Mean Turned Angle (MTA) records in the General Survey software.

Backsight observations cannot be skipped using the *Skip obstructed foresights* option.

Station setup - Residuals screen

The *Station setup residuals* screen lists the residuals for each point observed in the station setup.

Use the *Station setup residuals* screen to do the following:

- To observe more points, tap + *Point*. In a conventional only survey, when one measurement is completed, the General Survey software can provide navigation information for further points, and a *Navigate* softkey is available. Tap *Navigate* to navigate to another point. If connected to a GNSS / GPS receiver or using a Trimble controller with internal GPS, the General Survey software can provide navigation information for any point, and a *Navigate* softkey is available. Tap *Navigate* to navigate to another point.
- To view the Station setup results, tap *Results*.
- To store the station setup, tap *Results* and then tap *Store*.
- To view/edit the details of a point, highlight the point and then tap *Details*.
- To view/edit the residuals of each individual observation to a point, tap the point in the list once.
- To start measuring rounds of observations to the points, tap *End face*.

Tips

- To highlight an item in a list, tap and hold the item for at least half a second.
- To sort a column in ascending or descending order, tap the column header. Tap the *Point* column header to sort the point in ascending or descending observed order.
- To change the residual display view, select an option from the drop-down list in the *Residuals* screen.
- To navigate to a point, tap + *Point* and then tap *Navigate*.

Notes

- A residual is the difference between the known position and the observed position of the backsight point(s).
- A foresight point that does not yet exist in the database has null residuals in the *Residuals* form.
- You cannot add the same point to a station setup more than once. To take further measurements to points already measured, select *End Face*. For more information, see [Measuring Rounds in Station setup plus or Resection](#).

Point - Residuals screen

The *Point residuals* screen lists the residuals for each observation to a point in the station setup.

Use the *Point residuals* screen to do the following:

- To disable an observation, highlight it and then tap *Use*.
- To view the details of an observation, highlight it and then tap *Details*.

- To return to the *Station setup residuals* screen, tap *Back*.

Note - If you have measured face 1 and face 2 observations to a point, turning off the observation for one face will also turn off the observation for the other face.

Warning - If you turn off some (but not all) of the observations to a backsight point, the solution for the resection will be biased. There will be a different number of observations to each backsight point.

Point details screen

Use the *Point details* screen to:

- view the mean observation for a point in the station setup
- change the target height and/or prism constant for all observations to a point

Station setup results screen

The *Station setup results* screen shows information about the station setup solution.

Use the *Station setup results* screen to:

- return to the *Station Setup Residuals* screen (tap *Esc*)
- store the station setup (tap *Store*)

Note - During a *Station setup plus*, nothing is stored in the job until you tap *Store* in the *Results* screen.

Station setup is complete.

For more information, see:

[Measuring Rounds in Station setup plus or Resection](#)

[Advanced Geodetics support](#)

[Resection](#)

Measuring Rounds in Station setup plus or Resection

This topic describes how to measure multiple sets (rounds) of observations during a *Station setup plus* or *Resection*.

A round can consist of either:

- a set of single face 1 observations
- a set of matched face 1 and face 2 observations

Using *Station setup plus* or *Resection*, measure the points that you want to include in the rounds. When the rounds list has been built, tap *End Face*.

General Survey software:

- Directs you to change face when required. With servo-driven instruments, this happens automatically.
- Defaults to the correct point details for each observed point.
- Displays the results. This allows you to delete bad data.

For more details, see:

[Building a rounds list](#)

[Measuring rounds of observations](#)

[Skipping observations](#)

[Residuals screen](#)

[Point - Residuals screen](#)

[Point details screen](#)

[Automated rounds](#)

Building a rounds list

The rounds list contains the points used in the rounds observations. As each point is added to a *Station setup plus* or *Resection*, General Survey software automatically builds this list. For more information, see [Station setup plus](#) or [Resection](#).

When the rounds list is complete, tap *End face*. General Survey software prompts you for the next point to be measured in the rounds of observations.

Notes

- You can not edit the rounds list. Before you tap *End face*, be sure to observe all points to include in the rounds observations.
- The top of the *Measure rounds* screen shows which face the instrument is on, the number of the current round, and the total number of rounds to be measured (shown in brackets). For example, Face 1 (1/3) shows that the instrument is on face 1 of the first round of three.
- Within *Station setup plus* or *Resection*, the maximum number of points in a round is 25.

Measuring rounds of observations

Once the rounds list has been built, tap *End face*. General Survey software enters the default point name and target information for the next point in the rounds. To measure a point, tap *Measure*. Repeat this until all

observations in the round are completed.

When all observations are complete, General Survey software shows the [Residuals](#) screen.

Notes

- When using servo or robotic instruments, check that the instrument has sighted the target accurately. Manually adjust it if necessary. Some instruments can perform accurate sighting automatically. For information on the instrument specifications, refer to the instrument manufacturer's documentation.
- If you are using a servo or robotic instrument to measure a known (coordinated) point, tap *Turn*. Alternatively, with a servo instrument, set the *Servo auto turn* field in the survey style to *HA & VA*, or *HA only* to automatically turn the instrument to the point.
- If you tap *Esc* in the *Measure* screen, the current round is discarded.

Skipping observations

When using *Automate rounds* you can configure the software to automatically skip obstructed foresight targets.

If the instrument cannot measure the point and *Skip obstructed foresights* is **enabled**, it skips that point and moves onto the next point in the rounds list.

If the instrument cannot measure the point and *Skip obstructed foresights* is **disabled**, a message appears after 60 seconds to indicate that the prism is obstructed.

The General Survey software continues to try to measure to the target until instructed to skip the point. To do this, tap *Ok* for the obstructed prism message, tap *Pause* and then tap *Skip*.

When the General Survey software reaches the end of a rounds list in which points have been skipped, the following message appears:

Observe skipped points?

Tap *Yes* to observe the points that were skipped during that round. The observations can be skipped again if required. Tap *No* to end the round.

If a point is skipped in one round, all subsequent rounds continue to prompt for observations to that point.

When one observation from a pair of face 1 and face 2 observations has been skipped, the unused observation is automatically deleted by the General Survey software. Deleted observations are stored in the General Survey database and can be undeleted. Undeleted observations can be processed in the office software, but are not automatically used to recompute Mean Turned Angle (MTA) records in the General Survey software.

Backsight observations cannot be skipped using the *Skip obstructed foresights* option.

Residuals screen

At the end of each round, the *Residuals* screen appears. For more information, see [Station setup plus](#) or [Resection](#).

After you measure rounds, *Std Dev* becomes available in the *Residuals* screen. To view the standard deviations of the observations for each point, tap *Std Dev*.

Notes

- To change the residual display view, use the drop-down list in the *Residuals* screen.
- During a station setup plus or resection, nothing is stored to the job until you tap *Close* and *Store* to complete the station setup.

Point - Residuals screen

The *Point - Residuals* screen shows the residuals for the individual observations to a particular point. For more information, see [Station setup plus](#) or [Resection](#).

Note - If you have measured both face 1 and face 2 observations to a point, when you turn off a face 1 observation, you also turn off the corresponding face 2 observation. Similarly, when you turn off a face 2 observation, you also turn off the corresponding face 1 observation.

Point details screen

The *Point details* screen shows the point name, code, backsight status, target height, prism constant, mean observation, and standard errors for the observed point. For more information, see [Station setup plus](#) or [Resection](#).

Automated rounds

The *Automate rounds* option is available for Trimble VX Spatial Station or Trimble S Series total station and 5600 instruments. When you select *Automate rounds*, the instrument automatically completes all rounds after the rounds list has been built.

If you tap + *Round* after the instrument has completed the required number of rounds, the instrument performs one more round of observations. If you want the instrument to perform more than one extra round, enter the total number of required rounds **before** you tap + *Round*.

For example, to measure three rounds automatically, and then measure another three rounds:

1. Enter 3 in the *Number of rounds* field.
2. Once the instrument has measured 3 rounds, enter 6 in the *Number of rounds* field.
3. Tap + *Round*. The instrument measures the second group of 3 rounds.

Note - Targets observed without Autolock are automatically paused.

Station Elevation

In a conventional survey, use the station elevation function to determine the elevation of the instrument point by making observations to points with known elevations.

Note - Use only points that can be viewed as grid coordinates. (The station elevation calculation is a grid calculation.)

A station elevation needs at least one of the following:

- one angles and distance observation to a known point, or
- two angles only observations to different points

To perform a station elevation:

1. From the main menu, select *Measure* and then perform a [station setup](#) , [station setup plus](#) , [resection](#) , or [refline](#).
2. Select *Measure / Station elevation*. The instrument point name and code appear. If you entered the instrument height during the station setup, that also appears. Otherwise, enter the instrument height now. Tap *Accept*.

When measuring to the bottom notch on a Trimble VX Spatial Station or Trimble S Series total station, tap the advanced pop-up arrow () and then select *Bottom notch*. Enter the height measured to the top ridge of the bottom notch on the instrument.

General Survey corrects this measured slope value to true vertical and adds the offset 0.158 m (0.518 sft) to calculate true vertical to the trunnion axis.

Note - If you select *Bottom notch*, the minimum slope distance (Hm) that you can enter is 0.300 meters. This is approximately the minimum slope distance that can be physically measured. If this minimum is too low, you must measure to the top mark.

3. Enter the point name, code, and target details for the point with the known elevation. Tap *Measure*. Once the measurement is stored, the *Point residuals* appear.
4. From the *Point residuals* screen, tap one of the following softkeys:
 - ◆ *+ Point*, to observe additional known points
 - ◆ *Details*, to view or edit point details
 - ◆ *Use*, to enable or disable a point
5. To view the station elevation result, tap *Results* in the *Point residuals* screen. To accept the result, tap *Store*.

Note - The elevation determined through this station elevation method overwrites any existing elevation for the instrument point.

Resection

In a conventional survey, the resection function is used to perform a station setup and determine coordinates for an unknown point by making observations to known backsight points. The General Survey software uses a least-squares algorithm to compute the resection.

Note - To determine the elevation of a point with known 2D coordinates, perform a station elevation once you have completed a station setup.

A resection needs at least one of the following:

- Two angles and distance observations to different backsight points
- Three angles-only observations to different backsight points
- One angles and distance observation to a close-by point and one angles-only observation to a backsight point. This is a special case called eccentric station setup.

Warning - Do not compute a resection point using WGS84 control and then change the coordinate system or perform a site calibration. If you do, the resection point will be inconsistent with the new coordinate system.

For more details, see:

[Performing a resection](#)

[Resection - Residuals screen](#)

[Point - Residuals screen](#)

[Point details screen](#)

[Resection results screen](#)

[Eccentric station setup](#)

Performing a resection

To perform a resection:

1. From the main menu, select *Measure* / *<Style name>* / *Resection*.

Note - If you have only one style, it is automatically selected.

2. Set the [corrections](#) associated with the instrument.

If the *Corrections* form does not appear, tap *Options* and then select the *Show corrections on startup* check box.

3. Enter an instrument point name and instrument height, if applicable.

When measuring to the bottom notch on a Trimble VX Spatial Station or Trimble S Series total station, tap the advanced pop-up arrow () and then select *Bottom notch*. Enter the height measured to the top ridge of the bottom notch on the instrument.

General Survey corrects this measured slope value to true vertical and adds the offset 0.158 m (0.518 sft) to calculate true vertical to the trunnion axis.

Note - If you select *Bottom notch*, the minimum slope distance (Hm) that you can enter is 0.300 meters. This is approximately the minimum slope distance that can be physically measured. If this minimum is too low, you must measure to the top mark.

Note - Once the resection is started you cannot enter a different instrument height.

4. Set the *Compute station elevation* check box and then tap *Accept*.

Note - For a 2D or planimetric survey, clear the *Compute station elevation* check box. No elevations is calculated

Warning - Before you continue, tap *Options* and make sure that the *Face order* setting is correct. You cannot change this setting after you start measuring points.

5. Enter the first backsight point name and the target height, if applicable.

When measuring to the bottom notch on a [Trimble prism base](#), tap the advanced pop-up arrow () and then select *Bottom notch*.

Note - In a resection, you can only use backsight points that can be viewed as grid coordinates. This is because the resection calculation is a grid calculation.

6. Choose an option in the *Method* field.

7. Sight the target and then tap *Measure*.

8. Measure further points.

Note - To include foresight points during resection, clear the *Backsight* check box. Foresight points do not contribute to the resection result.

In a conventional survey, when two measurements are completed, the General Survey software can provide navigation information for further points, and a *Navigate* softkey is available. Tap *Navigate* to navigate to another point.

If connected to a GNSS / GPS receiver or using a Trimble controller with internal GPS, the General Survey software can provide navigation information for any point, and a *Navigate* softkey is available. Tap *Navigate* to navigate to another point.

9. When there is enough data for the General Survey software to calculate a resected position, the *Resection residuals* screen appears.

Resection - Residuals screen

The *Resection residuals* screen lists the residuals for each point observed in the resection.

Use the *Resection residuals* screen to do the following:

- To observe more points, tap + *Point*.
- To view the resection results, tap *Close*.
- To store the resection, tap *Close* and then tap *Store*.

- To view/edit the details of a point, highlight the point and then tap *Details*.
- To view/edit the residuals of each individual observation to a point, tap the point in the list once.
- To start measuring rounds of observations to the points, tap *End face*.

Tips

- To highlight an item in a list, tap and hold the item for at least half a second.
- To sort a column in ascending or descending order, tap the column header. Tap the *Point* column header to sort the point in ascending or descending observed order.
- To change the residual display view, select an option from the drop-down list in the *Residuals* screen.

Notes

- A residual is the difference between the known position and the observed position of the backsight point(s).
- A foresight point that does not yet exist in the database has null residuals in the *Residuals* form.
- You cannot add the same point to a resection more than once. To take further measurements to points already measured, select *End Face*. For more information, see [Measuring Rounds in Station setup plus or Resection](#).
- Within Station setup plus or Resection, the maximum number of points in a round is 25.

Point - Residuals screen

The *Point residuals* screen lists the residuals for each observation to a point in the resection.

Use the *Point residuals* screen to do the following:

- To disable an observation, highlight it and then tap *Use*.
- To view the details of an observation, highlight it and then tap *Details*.
- To return back to the *Resection residuals* screen, tap *Back*.

Note - If you have measured face 1 and face 2 observations to a point, turning off the observation for one face will also turn off the observation to the other face.

Warning - If you turn off some (but not all) of the observations to a backsight point, the solution for the resection will be biased because there will be a different number of observations to each backsight point.

Point details screen

The *Point details* screen shows the mean observation for a point in the resection.

Use the *Point details* screen to do the following:

- change whether the horizontal component or the vertical component of a point will be used in the resection calculation
- change the target height and/or prism constant for all observations to that point

Note - You can only change which components of a point will be used in the resection calculation if you have selected the compute station elevation option, and the observed point has a 3D grid position.

The *Used for* field shows the point components used in the resection calculation. See the following table.

Option	Description
H (2D)	Use only the horizontal values for that point in the calculation
V (1D)	Use only the vertical values for that point in the calculation
H,V (3D)	Use both the horizontal and vertical values for that point in the calculation

Resection results screen

The *Resection results* screen shows information about the resection solution.

Use the *Resection results* screen to do the following:

- To return to the *Resection residuals* screen, tap *Esc*.
- To store the resection, tap *Store*.

Note - During a resection, nothing is stored in the job until you tap *Store* in the *Results* screen.

Resection is complete.

Eccentric station setup

You can use the resection function to perform an eccentric station setup, where the station setup is performed in view of a close-by control point and in view of at least one backsight point. For example, use this setup if you cannot set up over the control point, or you cannot see any backsight points from the control point.

An eccentric station setup needs at least one angles and distance observation to a close-by control point, and one angles-only observation to a backsight point. Additional backsight points can also be observed during an eccentric station setup. You can measure backsight points with angles-only observations or with angles and distance observations.

For more information, see:

[Measuring Rounds in Station setup plus or Resection](#)

[Advanced Geodetics support](#)

[Station setup plus](#)

Reflines

Reflines is the process of establishing the position of an occupied point relative to a baseline. To perform a reflines station establishment, take measurements to two known or unknown baseline definition points. Once this occupation point is defined, all subsequent points are stored in terms of the baseline using station and offset. This method is often used when setting out buildings parallel to other objects or boundaries.

To perform a Reflines station setup:

1. From the main menu, select *Measure* / *<Style name>* / *Reflines*.
2. Set the **corrections** associated with the instrument.

If the *Corrections* form does not appear, tap *Options* and then select the *Show corrections on startup* check box.

3. Enter an *Instrument point name* and *Instrument height*, if applicable.

When measuring to the bottom notch on a Trimble VX Spatial Station or Trimble S Series total station, tap the advanced pop-up arrow () and then select *Bottom notch*. Enter the height measured to the top ridge of the bottom notch on the instrument.

General Survey corrects this measured slope value to true vertical and adds the offset 0.158 m (0.518 sft) to calculate true vertical to the trunnion axis.

Note - If you select *Bottom notch*, the minimum slope distance (Hm) that you can enter is 0.300 meters. This is approximately the minimum slope distance that can be physically measured. If this minimum is too low, you must measure to the top mark.

4. Tap *Accept*.
5. Enter the *Point 1 name*, and *Target height*.
 - If point 1 has known coordinates, the coordinates are displayed.
 - If point 1 does not have known coordinates, default coordinates are used. Select *Options* to change the default coordinates.
6. Tap *Meas 1* to measure the first point.
7. Enter the *Point 2 name*, and *Target height*.
 - If point 1 has known coordinates, a point with known coordinates can be used for point 2.
 - If point 1 does not have known coordinates then a point with known coordinates can not be used at point 2.
 - If point 1 does not have known coordinates, the default coordinates are used. Select *Options* to change the default coordinates.
 - If point 1 and point 2 had known coordinates the computed reflines azimuth is displayed, otherwise the default azimuth 0° is displayed.
8. Enter a *Reflines azimuth*, if applicable.
9. Tap *Meas 2* to measure the second point.

The instrument point coordinates are displayed.

10. Tap *Store* to complete the refline station establishment.

Once the Refline setup is stored, all subsequent points are stored in terms of the baseline as a station and offset.

If a line does not already exist, one is automatically created between the two points, using the naming scheme "<Point 1 name>-<Point 2 name>". You can enter the *Start station* and *Station interval*. If the line between the two points does already exist, the existing station is used and cannot be modified.

Note - In a refline station establishment, you can only use existing points that can be viewed as grid coordinates. This is because the refline calculation is a grid calculation. You can use 2D and 3D grid coordinates to define the baseline.

Station setup plus, Resection, and Rounds Options

There are up to four main settings that control the order in which the observations are taken, and how many observations are made during Station setup plus, Resection, and Rounds:

- [Face order](#)
- [Observation order](#)
- [Number of rounds](#)

Face order options

- *F1 only* - observations are taken only on face 1
- *F1... F2...* - all face 1 observations are taken to all points and then all face 2 observations are taken to all points
- *F1/F2...* - face 1 and then face 2 observations are taken to the first point, face 1 and then face 2 observations are taken to the next point, and so on

Observation order options

- *123.. 123*
- *123.. 321*

When the *Face order* is set to *F1... F2...* :

- *123.. 123* - observations on face 2 are taken in the same order as the observations on face 1
- *123.. 321* - observations on face 2 are taken in the reverse order to the observations on face 1

When the *Face order* is set to *F1 only* or *F1/F2* :

- *123.. 123* - each round of observations is taken in the same order

- 123.. 321 - every alternate round of observations is taken in the opposite order

Number of rounds option

This option controls the number of complete rounds of observations that are taken to each point.

Skipping Observations

When using *Automate rounds* you can configure the software to automatically skip obstructed foresight targets.

If the instrument cannot measure the point and *Skip obstructed foresights* is **enabled**, it skips that point and moves onto the next point in the rounds list.

If the instrument cannot measure the point and *Skip obstructed foresights* is **disabled**, a message appears after 60 seconds to indicate that the prism is obstructed.

The General Survey software continues to try to measure to the target until instructed to skip the point. To do this, tap *Ok* for the obstructed prism message, tap *Pause* and then tap *Skip*.

When the General Survey software reaches the end of a rounds list in which points have been skipped, the following message appears:

Observe skipped points?

Tap *Yes* to observe the points that were skipped during that round. The observations can be skipped again if required. Tap *No* to end the round.

If a point is skipped in one round, all subsequent rounds continue to prompt for observations to that point.

When one observation from a pair of face 1 and face 2 observations has been skipped, the unused observation is automatically deleted by the General Survey software. Deleted observations are stored in the General Survey database and can be undeleted. Undeleted observations can be processed in the office software, but are not automatically used to recompute Mean Turned Angle (MTA) records in the General Survey software.

Backsight observations cannot be skipped using the *Skip obstructed foresights* option.

Automate rounds

The *Automate rounds* option is available for Trimble VX Spatial Station or Trimble S Series total station and 5600 instruments. When you select *Automate rounds*, the instrument automatically completes all rounds after the rounds list has been built.

A 3-second delay between automated rounds enables you to check the standard deviations before the next round starts automatically.

If a target has been blocked, the instrument tries to measure the point for up to 60 seconds. After 60 seconds has elapsed it skips the observation and moves to the next point in the rounds list.

If you tap + *Round* after the instrument has completed the required number of rounds, the instrument performs one more round of observations. If you want the instrument to perform more than one extra round, enter the total number of required rounds **before** you tap + *Round*.

For example, to measure three rounds automatically, and then measure another three rounds:

1. Enter 3 in the *Number of rounds* field.
2. Once the instrument has measured 3 rounds, enter 6 in the *Number of rounds* field.
3. Tap + *Round*. The instrument measures the second group of 3 rounds.

Note - Manually observed targets are automatically paused.

Conventional Instrument - Corrections

You can set the corrections associated with conventional observations.

Note - If you intend to perform a network adjustment in the Trimble Business Center software using data from a conventional survey, make sure that you enter a pressure, temperature and, curvature and refraction correction.

Use the *PPM* (Parts Per Million) field to specify a PPM correction to be applied to electronic distance measurements. Key in the PPM correction, or enter the pressure and temperature of the surrounding environment and let the General Survey software compute the correction.

Typical pressure ranges are between 500 mbar - 1200 mbar, but when you work in an area with over-pressure (for example, a tunnel), larger pressures up to 3500 mbar are possible.

Note - If you are using a Trimble VX Spatial Station or Trimble S Series total station, the pressure field is set automatically from the sensor in the instrument. To disable this, tap the advanced pop-up arrow and then clear the *From instrument* check box.

Use the *Curvature* and *Refraction* fields to control curvature and refraction corrections. The earth curvature and refraction corrections are applied to vertical angle observations and therefore have an impact on computed vertical distance values. They also affect the horizontal distance values to a very small extent.

The earth curvature and refraction corrections can be applied independently using the options provided. The earth curvature correction is the most significant correction with a magnitude of approximately 16" per km measured distance (subtracted from the zenith vertical angle).

The magnitude of the refraction correction is affected by the refraction coefficient, which is an estimate of the change in air density along the light path from the instrument to the target. Since this change in air density is affected by factors such as temperature, ground conditions, and the height of the light path over ground, it is very difficult to determine exactly which refraction coefficient to use. If you use typical refraction coefficients such as 0.13, 0.142, or 0.2, the refraction correction results in a correction in the opposite direction to the earth curvature correction with a magnitude of approximately one-seventh of the earth curvature correction.

Note - The DC file format only supports a curvature and refraction correction that are both off, or both on, and when on, either with a coefficient of 0.142 or 0.2. When settings other than these are used in the General Survey software, the settings exported to the DC file will be a best match.

Note - Do not set corrections in both devices. To set them in the General Survey software, make sure the instrument settings are null.

For some instruments, the General Survey software automatically checks to see if various corrections (PPM, prism constant, and curvature and refraction) are being applied correctly. If it finds that the corrections are being applied twice, a warning message appears.

In the following table, the * symbol in a field indicates that the correction at the top of that column is applied.

Note - '*' applies only to computed coordinates when a station setup has been defined.

Displayed / Stored data	Corrections applied										
	C / R	PPM	PC	SL	Orient	Inst ht	Tar ht	Proj Cor	Stn SF	NA	POC
Status line	-	-	-	-	-	-	-	-	-	-	-
HA VA SD (raw)	-	-	-	-	-	-	-	-	-	-	-
HA VA SD	*	*	*	-	-	-	-	-	-	-	*
Az VA SD	*	*	*	-	*	-	-	-	-	-	*
Az HD VD	*	*	*	-	*	*	*	*	*	-	*
HA HD VD	*	*	*	-	-	*	*	*	*	-	*
Grid	*	*	*	*	*	*	*	*	*	*	*
delta Grid	*	*	*	*	*	*	*	*	*	*	*
Station and offset	*	*	*	*	*	*	*	*	*	*	*
DC file (observations)	-	-	-	-	-	-	-	-	-	-	*
DC file (reduced coordinates)	*	*	*	*	*	*	*	*	*	*	*
JobXML (observations)	-	-	-	-	-	-	-	-	-	-	*
JobXML (reduced coordinates)	*	*	*	*	*	*	*	*	*	*	*
Survey Basic	*	*	*	*	*	*	*	*	*	*	*

The following table explains the corrections used above.

C / R	Curvature and/or Refraction correction.
PPM	Atmospheric Parts Per Million correction - PPM is calculated from temperature and pressure.
PC	Prism constant correction.
SL	Sea level (ellipsoid) correction. - this correction is applied only if a fully defined coordinate system definition is being used; the correction is not applied in the <i>Scale factor only</i> definition.

Orient	Orientation correction.
Inst ht	Instrument height correction.
Tar ht	Target height correction.
Proj Cor	Projection correction. - this includes the application of a scale factor specified in the <i>Scale factor only</i> definition.
Stn SF	Station setup scale factor. - in any station setup, a scale factor for this setup can be specified or computed. This scale factor is applied in the reduction of all observations from this station setup.
NA	Neighborhood adjustment. - in a station setup defined using <i>Station setup plus</i> or <i>Resection</i> , a neighborhood adjustment can be applied. The neighborhood adjustment is computed based on the observed residuals to the control points used during the station setup. The adjustment is applied, using the specified exponent value, in the reduction of all observations from this station setup.
POC	Prism offset correction - only applied when using a Trimble 360° prism or a Trimble MultiTrack target.

Target Details

You can configure the details of the target during a conventional survey.

When connected to a conventional instrument the Target icon appears in the status bar. The number next to the target icon indicates the target currently in use. To alternate between targets or to edit the target height and the [prism constant](#), tap the target icon. To select the target to use, tap the appropriate target in the pop-up list. You can create up to five non-DR targets.

Tip - To change to a target, select the target name. To edit entries in the *Target* form, select the target height or prism constant.

Note - If you are using a Trimble VX Spatial Station or Trimble S Series total station, the *Pressure* field is set automatically from the sensor in the instrument. To disable this, tap the advanced pop-up arrow and then clear the *From instrument* check box.

When using Trimble prisms, select the *Prism type* to automatically define the prism constant. When using non-Trimble prisms, select *Custom* to manually enter the prism constant.

When the Trimble *VX/S Series 360°* prism type is selected, the General Survey software applies a correction to the Vertical Angle and Slope Distance to correct for the offset difference between the optical center of the prism and the center line of the rod.

The correction is only significant when observing step vertical angles.

When connected to a DR instrument, Target DR is used to define the DR target height and prism constant. To enable DR, select Target DR. To disable DR and return the instrument to its last state, select target 1 - 5.

When measuring to the bottom notch on a Trimble prism base, tap the advanced pop-up arrow () and then select *Bottom notch*.

General Survey corrects this measured slope value to true vertical and adds the offset 0.158 m (0.518 sft) to calculate the true vertical height to the center of the prism.

Note - If you select *Bottom notch*, the minimum slope distance (Hm) that you can enter is 0.300 meters. This is approximately the minimum slope distance that can be physically measured. If this minimum is too low, you must measure to the top mark.

For details, see the following figure and table.

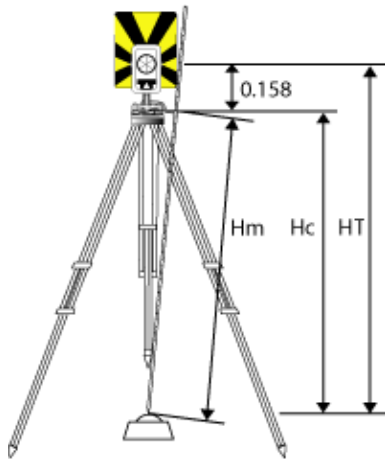

0.158m	Offset from bottom notch to center of prism.
Hm	Measured slope distance.
Hc	Hm corrected from slope to true vertical.
HT	True vertical target height. Hc + 0.158m.

To add a new target:

1. Tap the target icon in the status bar and then tap the height or prism constant for Target 1.
2. In the *Target 1* screen, tap *Add* to create Target 2.
3. Enter the details for *Target 2* and then tap *Accept*.
4. Target 2 now becomes the active target.

To delete a target from the list:

1. Tap the target icon in the status bar and then tap the height or prism constant.
2. In the *Target* screen, tap *Delete*. The Target is removed from the list.

Note - You can not delete Target 1 or Target DR.

To edit a target height:

1. Tap the target icon in the status bar.

2. Tap the target height for the target you want to edit.
3. Edit the target details and then tap *Accept*.

To edit target heights of observations already stored to the job, do one of the following:

- For a single observation or multiple observations using the same or different targets, use [Point Manager](#).
- For a single target record, and subsequently a group of observations that use that target, use [Review job](#).

Target tracking with the Trimble VX Spatial Station or Trimble S Series total station

If you use a Trimble VX Spatial Station or Trimble S Series total station with search capabilities and a Trimble VX/S Series 360° prism, custom prism, or a Trimble MultiTrack target, you can configure the software to use an Active Target ID.

Note - If you use a Trimble VX Spatial Station or Trimble S Series total station with the Trimble MultiTrack target, you must upgrade the instrument to firmware version R7.0.35 or later. The Trimble VX Spatial Station or Trimble S Series total station firmware is available on www.trimble.com.

When using the [Trimble MultiTrack target](#), the **Tracking mode** can be set to:

- [Passive](#)
- [Active](#)

Tracking mode - Passive

If you do not operate in a reflective environment, set the *Tracking mode* to *Passive*.

To do this:

1. Tap the target icon on the status bar.
2. Select the *Target height* or *Prism constant* field to open the *Target* form.
3. Set the *Prism type* to VX/S Series MultiTrack.
4. Set the *Tracking mode* to *Passive*.

Tracking mode - Active

If you operate in a highly reflective environment, or on a site with many prisms, set the *Tracking mode* to *Active* to ensure that you maintain constant lock to the correct target.

To do this:

1. Tap the target icon on the status bar.
2. Do one of the following:
 - Select the *Target height* or *Prism constant* field to open the *Target* form.

3. Set the *Prism type* to VX/S Series MultiTrack.
4. Set the *Tracking mode* to Active.
5. Set the *Target ID* to match the identification number in the Target ID on the robotic rover.

When using the Trimble VX/S Series 360° prism or a custom prism, the **Target ID** can be set to:

- Off - the ID is not checked.
- [Search](#) - check the ID when a search is initiated.
- [Search and measure](#) - check the ID when a search is initiated, and when a measurement is initiated.
- [Always](#) - the ID is constantly being checked by the instrument.

Check the target ID - Search

If you operate in an environment with few reflective surfaces, but you want to ensure that if you do a search you will lock to the correct target, set *Check target ID* to *Search*.

To do this:

1. Tap the target icon on the status bar.
2. Do one of the following:
 - If available, select the *Target ID* field.
The *Target ID* field is available only when you use an VX/S Series 360° prism, and *Check target ID* is not set to Off.
 - Select the *Target height* or *Prism constant* field to open the *Target* form.
3. Set the *Prism type* to VX/S Series 360°.
4. Set the *Check target ID* to Search.
5. Set the *Target ID* to match the identification number in the Target ID on the Trimble Standard Rod.

Check the target ID - Search and measure

If you operate in an environment with few reflective surfaces, but you want additional assurance if you do a search or when you measure that you will lock to the correct target, set *Check target ID* to *Search and measure*.

To do this:

1. Tap the target icon on the status bar.
2. Do one of the following:
 - If available, select the *Target ID* field.
The *Target ID* field is available only when you use an VX/S Series 360° prism, and *Check target ID* is not set to Off.
 - Select the *Target height* or *Prism constant* field to open the *Target* form.
3. Set the *Prism type* to VX/S Series 360°.
4. Set the *Check target ID* to Search and measure.

5. Set the *Target ID* to match the identification number set in the Target ID on the Trimble Standard Rod.

Check the target ID - Always

If you operate in a reflective environment, and require precise elevations set *Check target ID* to *Always* to ensure that you maintain constant lock to the correct target.

To do this:

1. Tap the target icon on the status bar.
2. Do one of the following:
 - If available, select the *Target ID* field.
The *Target ID* field is available only when you use an VX/S Series 360° prism, and *Check target ID* is not set to Off.
 - Select the *Target height* or *Prism constant* field to open the *Target* form.
3. Set the *Prism type* to VX/S Series 360°.
4. Set the *Check target ID* to Always.
5. Set the *Target ID* to match the identification number in the Target ID on the robotic rover.

Notes

- When passive tracking is used to maintain vertical lock to the prism, you must be aware that there is a risk of nearby reflective surfaces interfering with the vertical tracking.

For more information on the different *Check target ID* modes, see [Target ID - Target tracking with Trimble VX Spatial Station or Trimble S Series total station](#).

Prism Constant

The prism constant (distance offset) must be set for each prism that is used as a target in a conventional survey.

To edit a prism constant:

1. Tap the target icon in the status bar.
2. Tap the prism constant for the target you want to edit.
3. Edit the prism constant details and then tap *Accept*.
Enter a negative value if the prism constant is to be subtracted from measured distances. Enter the Prism constant in millimeters (mm).

When using a Trimble VX Spatial Station or Trimble S Series total station, 5600, or 3600 instrument, all corrections are applied in General Survey.

To review or edit the prism constant on previously stored observations, tap *Favorites / Review job* or tap *Jobs / Point manager*. For more information, see [Point Manager](#).

Advanced Geodetic Support

To enable the following options for Advanced Geodetic support: when creating a new job, tap *Job / New job / Cogo settings*; for an existing job, tap *Job / Properties of job / Cogo settings*.

- [Station setup scale factor](#)
- [Helmert transformation for Resection](#)

Station setup scale factor

When you turn on Advanced Geodetic support, you can apply an additional scale factor to every conventional station setup. All measured horizontal distances are adjusted by this scale factor. To configure the scale factor settings, select *Options* during a *Station setup*, *Station setup plus*, or *Resection*.

This station setup scale factor can be Free (computed) or Fixed. If you have chosen to compute a station setup scale factor, you must observe at least one distance to a backsight during the station setup so that a scale factor can be calculated.

Helmert transformation for Resection

When you turn on Advanced Geodetic support, *Resection* has an additional computation method called Helmert transformation. To perform a resection using a Helmert transformation, select *Options* during a *Resection*, and then set the *Resection type* to *Helmert*.

Note - The standard resection type is the same as the resection method used when Advanced Geodetics is turned off.

For a Helmert transformation, you must measure distances to the backsight points. The resection calculation will not use a backsight point without a distance measurement.

For more information, see [Neighborhood Adjustment](#).

Start the Survey

To begin surveying, select the required survey method from *Measure*.

Note - If there is only one survey style, it is automatically selected when you start a survey. Otherwise, select a style from the list that appears.

End the survey

To do this:

1. From the main menu, select *Measure / End conventional survey*.
2. Tap *Yes* to confirm.
3. Turn off the controller.

Warning - The current station setup is lost when you select *End conventional survey*.

If a survey is running, end it before editing the current survey style or changing survey styles. You must also end the survey before accessing job functions such as copying. For more information, see [Job](#).

Conventional Survey - Measure

Measure Points

The *Measure* screen lets you record points measured using data from the connected conventional survey instrument.

To access the *Measure* screen, from the main menu tap *Measure*. The following measurements or calculations can be performed from the *Measure* screen:

To...	From the <i>Measure</i> screen, select...	And then...
Measure a topographic point	<i>Measure topo</i>	
Measure points with feature codes	<i>Measure codes</i> or <i>Measure topo</i>	
Measure multiple sets of observations	<i>Measure rounds</i>	
Define a plane and then measure points relative to the plane	<i>Measure points on a plane</i>	
Measure a point relative to a 3D axis	<i>Measure 3D axes</i>	
Measure a line of points at a fixed interval	<i>Continuous topo</i>	
Define a surface and then scan points on the surface	<i>Scanning</i> or <i>Surface Scan</i>	
Measure an inaccessible point	<i>Measure topo</i>	Select the <i>Distance offset</i> or the appropriate <i>angle offset</i> method
Measure a point that cannot be observed directly with a pole in plumb position	<i>Measure topo</i>	Select the <i>Dual-prism offset</i> method
Measure to a cylindrical object, and calculate the center point and radius of the object such as a pillar or water tank	<i>Measure topo</i>	Select the <i>Circular object</i> method
Calculate the height and/or width of a remote object if the instrument cannot easily measure a distance directly to the object	<i>Measure topo</i>	Select the <i>Remote Object</i> method
Measure a check class point	<i>Measure topo</i> Press CTRL + K	Tap the <i>Check</i> softkey

The General Survey software also enables you to:

- Capture panoramas when measuring points if the controller is connected to a Trimble V10 imaging rover.
- Measure and automatically store a construction point. For more information, see [Fast fix](#).
- [Measure a point on two faces](#).

Tip - In *Point name* fields there is a *Find* softkey that lets you search for the next available point name. For example, if your job contains points numbered in the 1000s, 2000s and 3000s, and you want to find the next available point name after 1000:

1. In the *Point name* field, tap *Find*. The *Find next free point name* screen appears.
2. Enter the point name you want to start searching from (in this example, 1000) and tap *Enter*.

The General Survey software searches for the next available point name after 1000 and inserts it in the *Point name* field.

Measuring topo points in a Conventional Survey

To measure a topographic point using the General Survey software and a conventional instrument:

1. From the *Measure* menu, select *Measure topo*.
2. Enter a value in the *Point name* field.
3. If necessary, enter a feature code in the *Code* field.
4. If you have enabled a measured point to be added to a CSV file, select the *Add to CSV file* option. The point will be stored in the displayed file name. To enable adding a file, see: [Add to CSV File](#).
5. In the *Method* field, select a measurement method.
6. Enter a value in the *Target height* field and then tap *Measure*.

When measuring to the bottom notch on a [Trimble prism base](#), tap the advanced pop-up arrow () and then select *Bottom notch*.

If you selected the [View before storage](#) check box in the survey style, the measurement information appears on the screen. If necessary, edit the target height and code. Tap the view display button on the left of the measurement information to change the display and then do one of the following:

If you did not select the [View before storage](#) check box, the point is stored automatically and the point name increments (based on the *Auto point step size* setting). The General Survey software stores the raw observations (HA, VA, and SD).

Notes

- If you selected the *Auto average* option in the survey style, and an observation to a duplicate point is within the specified duplicate point tolerances, the observation and the computed average position (using all the available point positions), are automatically stored.
- Two angles only observations from two different known points can be 'averaged' to compute the coordinates of the intersection point. To average the observations, they must be stored with the same point name. When the *Duplicate point: Out of tolerance* screen appears, select *Average*. Alternatively, average the observations using [Cogo / Compute average](#).

To [change the settings for the current survey](#), tap *Options*. You cannot change the current survey style or the system settings.

If you are using a servo or robotic instrument to measure a known (coordinated) point, tap *Turn*. Alternatively, with a servo instrument, set the *Servo auto turn* field in the survey style to *HA & VA*, or *HA only* to automatically turn the instrument to the point.

Tips

- You can tap *Enter* while measuring an *Averaged observations* to accept the measurement before the required number of observations has been completed.
- You can tap *Enter* while measuring a *Direct Reflex (DR)* point with a defined standard deviation to accept the measurement before the standard deviation has been satisfied.
- Instead of going to the *Measure* screen, you can access the *Measure topo* screen from the following:
 - ◆ From the *Favorites* menu, select *Measure points*.
 - ◆ From the Map, select *Measure* (only available when nothing in the map is selected).
- If you are measuring topo points with feature codes, you may find *Measure codes* faster and easier to use than *Measure topo*.

Measuring a Point in Two Faces

To start a conventional survey in the General Survey software, you must first perform a *Station setup* using one of the following methods:

- [Station setup](#)
- [Station setup plus](#)
- [Resection](#)
- [Reflines](#)

You can observe points using face 1 (direct) and face 2 (reverse) measurements during a station setup and during [Measure rounds](#) or [Measure topo](#).

Consider the station setup and the new point measurement method together and choose which to use according to how you want to capture and store the data.

If you only want to use a single backsight (measured on one or both faces), and measure some topo points (on one or both faces), then use *Station setup* and *Measure topo*. When you measure on both faces, remember to also measure the backsight on face 2 in *Measure topo*. Otherwise, all foresights on face 2 will be oriented using the face 1 backsight observation.

If you want to measure multiple backsights, measure multiple rounds, or obtain better quality control of your observations, see below for more information on different station setup and new point measurement methods in General Survey.

Use **Station setup plus** to:

- measure a single backsight point or multiple backsight points
- measure backsight and foresight points
- pair the face 1 and face 2 observations and create MTA records

- measure face 1 only observations and create MTA records
- measure one or more rounds of observations
- review the quality of the observations and remove bad observations

Use **Resection** to:

- coordinate the instrument point
- measure multiple backsight points
- measure backsight and foresight points
- pair the face 1 and face 2 observations and create MTA records
- measure face 1 only observations and create MTA records
- measure one or more rounds of observations
- review the quality of the observations and remove bad observations

Use **Station setup** to:

- perform a station setup with a single backsight measurement on one face only

Notes

- When measuring points on both faces, use *Measure topo* to observe the backsight on the other face. Alternatively, use *Measure rounds* and include the observation to the backsight point in the rounds.
- When you make topo observations after a *Station setup*, and you subsequently select *Measure rounds*, you must reobserve the backsight to include it in the rounds, generate an MTA to the backsight, and calculate turned angles from the backsight MTA for all foresight points.
- MTAs are not created during *Station setup*, but are created later if you make further observations to the backsight using *Measure topo* or *Measure rounds*.

Notes

- Standard deviations are only available after the second round of observations.
- If the station setup has a single backsight (from *Station setup* or *Station setup plus*), you can choose whether or not to include the backsight point in the rounds list.
- If the station setup has multiple backsights (from *Station setup plus* or *Resection*), the backsight points are not included in the rounds list.
- If you do not measure the backsight on face 2, then the horizontal angle face 2 measurements that were observed using *Measure rounds* will not be used when calculating the MTAs.
- When you use *Measure rounds* after a station setup with a single backsight, and you do not include the backsight point in the rounds list, all turned angles are calculated using the backsight observation(s) made during the station setup.

Use **Measure topo** (after performing a station setup) to:

- measure face 1 or face 2 observations and create MTA records

Note - You can measure multiple rounds using *Measure topo*. However, Trimble recommends *Measure rounds* as a more suitable method to use.

Additional notes about MTA records

- When you use *Station setup plus* or *Resection*, all observations are stored when the station setup is complete. When you use *Measure rounds*, the observations are stored at the end of each round. In all three options, the MTAs are stored at the end.
- When you use *Measure topo*, MTAs are calculated and stored on the fly.
- You can create MTAs during a station setup using *Station setup plus* and *Resection*, and also after a station setup using *Measure rounds* or *Measure topo*. When you measure the same point(s) using *Measure rounds* or *Measure topo* after *Station setup plus* and *Resection*, the General Survey software may produce two MTAs for the one point. When more than one MTA exists for the same point in one station setup, the General Survey software always uses the first MTA. To avoid having two MTAs for the same point, do not use both methods to measure a point.
- Once an MTA record is written to the job database, you cannot change it.
- You can delete a face 1 and face 2 observation but the MTA records are not updated.
- You cannot delete MTA records in review.
- In *Station setup plus*, *Resection*, or *Measure rounds*, when you use the F1... F2 or F1/F2... face order, MTAs that are created pair face 1 and face 2 observations.
- In *Station setup plus*, *Resection*, or *Measure rounds*, when you use the F1 only face order, MTAs that are created group face 1 observations.
- In *Measure topo*, MTAs that are created group together all observations for the same point.

Continuous topo - Conventional

Use the *Continuous topo* function to measure points continuously.

A point is stored when one of the following conditions occurs:

- a predefined time has elapsed
- a predefined distance has been exceeded
- both predefined time and/or distance settings have been met
- a predefined stop time and distance settings have been met

1. From the main menu, select *Measure / Continuous topo*.
2. Enter a value in the *Start point name* field. This increments automatically.
3. Enter a value in the *Target height* field.
4. In the *Method* field, select *Fixed distance*, *Fixed time*, *Time and distance*, or *Time or Distance*.
5. Enter a value in the *Distance* field and/or the *Time interval* field, depending on which method you are using.
6. Tap *Start* to start recording data and then move along the feature to be surveyed.
7. To stop measuring continuous points, tap *End*.

Tip - To store a position before the predefined conditions have been met, tap *Store*.

Synchronous and non-synchronous angles and distances

Continuous topo with a Trimble VX Spatial Station or Trimble S Series total station uses only

synchronous angles and distances.

To measure Continuous topo points using the *Stop and go* method:

1. From the main menu, select *Measure / Continuous topo*.
2. Enter a value in the *Start point name* field. This increments automatically.
3. Enter a value in the *Target height* field.
4. In the *Method* field select *Stop and go*.
5. Enter a value in the *Stop time* field for the period of time the target must be stationary before the instrument starts to measure the point.

The user is deemed to be stationary when their velocity is less than 5 cm/sec.

6. Enter a value in the *Distance* field for the minimum distance between points.

When you use an instrument that has a tracklight that has been enabled, the tracklight will be disabled for 2 seconds when the measured point has been stored.

Angles and distance

In a conventional survey, use this measurement method to measure a point by angles and a distance.

Angles only and H.Angle only

In a conventional survey, use this measurement method to measure a point by both a horizontal and vertical angle or by a horizontal angle only.

Averaged Observations

In a conventional survey, use the Averaged observations method to:

- increase the measurement precision with a predefined number of observations
- view the associated measurement standard deviations

To measure a point using the Averaged observations method:

1. From the *Measure* menu, select *Measure topo*.
2. In the *Point name* field, enter the name of the point.
3. In the *Code* field, enter a feature code (optional).
4. Select *Averaged observations* as the method.
5. Sight the target and tap *Measure*.
While the instrument is carrying out the measurements, standard deviations are displayed for the horizontal (HA) and vertical (VA) angles, and the slope distance (SD).
6. View the resulting observation data, and the associated standard deviations, in the *Store* screen.
If acceptable, tap *Store*.

Note - Use the options available in the *Measure topo* screen to change the number of observations taken by the instrument using averaged observations.

Angle Offset, H. Angle Offset, and V. Angle Offset

In a conventional survey, there are three angle offset methods that you can use to observe a point that is inaccessible; Angle offset, H. Angle offset, and V. Angle offset.

The *Angle offset* method holds the horizontal distance from the first observation, and combines this with the horizontal angle and vertical angle from the second observation to create an observation to the offset location.

The *V.Angle offset* method holds the horizontal distance and horizontal angle from the first observation, and combines this with the vertical angle from the second observation to create an observation to the offset location.

The *H.Angle offset* method holds the slope distance and vertical angle from the first observation, and combines this with the horizontal angle from the second observation to create an observation to the offset location.

All raw observables from the first and second observations are stored internally in the job file and are available in Custom ASCII Export.

To measure a point using one of the Offset methods:

1. From the *Measure* menu, select *Measure topo*.
2. In the *Point name* field, enter the name of the point.
3. In the *Code* field, enter a feature code (optional).
4. In the *Method* field, select *Angle offset*, *H. Angle Offset*, or *V. Angle Offset*.

When using the *H.Angle offset* measurement method, the target height from the first observation is applied to the horizontal angle offset observation.

When using *Angle offset* or *V.Angle offset* measurement methods you do not need to enter the *Target height*. The offset measurements are to the offset location and the target height is not used in any computations. To ensure that a target height is not applied to the observation, a target height of 0 (zero) is automatically stored to the General Survey software database.

5. Place the target beside the object to be measured, sight the target and then tap *Measure*.

The first observation is displayed.

Tip - When using Autolock technology and measuring offset points, select the *Autolock off for offsets* check box. When enabled, Autolock technology is automatically disabled for the offset measurement and then re-enabled after the measurement.

6. Turn to the offset location and then tap *Measure*. The two observations are combined into one:

- if you selected the *View before storage* check box in the survey style, the measurement values appear. Tap *Store* to store the point.
- if you did not select the *View before storage* check box, the point is stored automatically.

Note - The observation is stored in the database as raw HA, VA, and SD records.

Distance Offset

In a conventional survey, use this observation method when a point is inaccessible but a horizontal distance from the target point to the object can be measured.

Distance offset allows you to offset in one, two, or three distances in one step.

To measure a point using the *Distance offset* method:

1. From the *Measure* menu, select *Measure topo*.
2. In the *Point name* field, enter the name of the point.
3. In the *Code* field, enter a feature code (optional).
4. In the *Method* field, select *Distance offset*.
5. In the *Target height* field, enter the height of the target.
6. Tap *Options* and then set the *Offset & Stakeout directions* perspective.
7. Enter the *L/R offset* (left or right offset) from the target to the object, if applicable. If custom offsets were preconfigured, tap the pop-up arrow to select the offset.
8. Enter the *In/Out offset* from the target to the object, if applicable.
9. Enter the *V. Dist offset* from the target to the object, if applicable.

The following figure shows an example where point 5 is measured with the *Offset & Stakeout directions* set to *Instrument perspective*:

- ◆ offset to the left (2) of the target (3)
- ◆ offset out (4) from the instrument station (1)
- ◆ offset vertically (6)

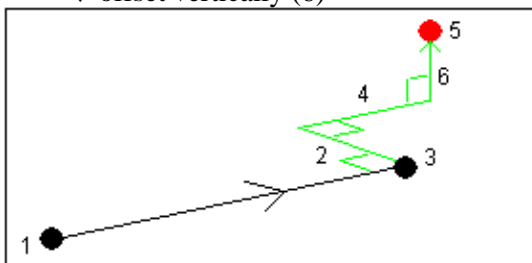

10. Tap *Measure*.

If you selected the *View before storage* check box in the survey style, the observation adjusted for the offset distance appears. Tap *Store* to store the point.

If you did not select the *View before storage* check box, the point is stored automatically.

The General Survey software stores the adjusted horizontal angle, vertical angle, and slope distance in the point record, as well as an offset record with the offset measurement details.

Offset & Stakeout directions

The left and right directions used in *Distance offset* depend on the *Offset & Stakeout directions* setting. You can configure this setting in the survey style and also from *Options*.

When looking from the instrument to the object, an object that is offset to the left when the *Offset & Stakeout directions* are set to *Instrument perspective* is to the left.

When the *Offset & Stakeout directions* is set to *Target perspective*, the object is to the right.

When the *Offset & Stakeout directions* are set to *Automatic*, the offset and stakeout directions are with respect to the *instrument* perspective in a Servo survey, and to the *target* perspective in a Robotic survey.

The measurements are editable in *Review job* and are always displayed in the perspective in which they were observed. The perspective cannot be changed in review. The measurement is always stored relative to the instrument position.

Measure Points on a Plane

In a conventional survey, the Measure points on a plane measurement method is used to define a plane and then measure points relative to the plane.

A horizontal plane, a vertical plane, or a tilted plane can be defined by selecting points in the job or measuring new points. After defining the plane, an *Angles only* measurement to the plane creates an angles and computed distance observation onto the plane. Alternatively, an *Angles and distance measurement* to the plane computes the perpendicular offset to the plane.

The type of plane calculated by the software depends on the number of points selected:

Number of points	Plane type
1	Horizontal
2	Vertical through 2 points
3	Fixed through 3 points (no residuals)
4 or more	Plane with residuals. The plane can be a "Free" plane created as a best fit (typically tilted) plane through all points, or a "Vertical" plane constrained to a best fit vertical plane through all points. Tap the <i>Free / Vertical</i> softkey to toggle between the two modes.

1. From the main menu, select *Measure / Measure points on plane*.
2. To define the plane:
 - a. Either tap *Add* to select the [point selection method](#) and then select the point(s) to use to define the plane, or tap *Measure* to go to the *Measure point* screen and measure a new point to use in

- the plane definition. Add or measure at least enough points to define the required plane.
 - b. Tap *Calculate* to calculate the plane.
 - c. If the plane uses 4 or more points, you can tap *Vertical* to calculate a vertically constrained plane. If required, tap *Free* to recalculate the plane using the best fit through all points.
 - d. Use the values in the *Residuals* column to identify any points that you want to exclude. Tap a row in the table to exclude or include a point and automatically recalculate the plane. The values in the *Residuals* column are updated.
3. Tap *Continue* to measure points relative to the plane.
 4. Enter a *Point name*.
 5. Select the *Method* to use for calculating the point:
 - ◆ *Angle and distance* calculates coordinates for the measured point as well as the distance from the point to the plane.
 - ◆ *Angle only* calculates coordinates for the observed point using the intersection of measured angles and the plane.
 6. Tap *Measure*.
 7. Tap *Store* to store the point in the database.

Tip - When measuring with *Angles and distance*, configure the instrument EDM settings to turn on tracking mode to see the delta distance to the plane field update in real time.

Measure 3D axes

To measure a point relative to a 3D axis using General Survey and a conventional instrument:

1. From the *Measure* menu, select *Measure 3D axes*.
2. Key in or measure the two points that define a 3D axis.

Tip - To measure a point, tap the pop-up menu button on the point name field and select *Measure* from the list of options displayed.

3. Tap *Options* to select the format of the delta display for the points measured relative to the axis.

The content and format of the delta display is controlled by XSLT style sheets. Translated default XSLT Measure 3D Axes Style Sheet (*.3ds) files are included with the language files, and accessed by General Survey from the language folders. You can create new formats in the office and then copy them to the [Systems files] folder on the controller.

4. Tap *Next*.

The instrument is automatically put into TRK mode. When General Survey receives a distance, the deltas fields are automatically updated.

If you are not measuring to a prism, use Instrument functions to set DR mode.

You can accept the TRK measurement, or tap *Measure* to take an STD measurement.

The General Survey software reports the coordinates and elevation for the measured point, and the

orthogonal and vertical deltas for the point relative to the 3D axis. The following diagram and table describes the reported deltas using the default format.

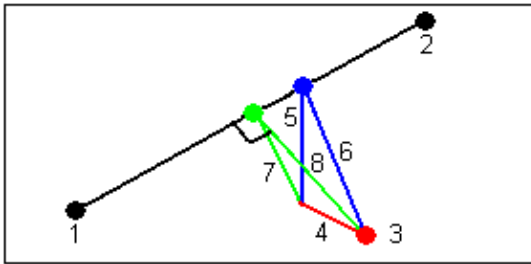

1	Point 1 defining the 3D axis	5	Vertical offset to vertical point on 3D axis
2	Point 2 defining the 3D axis	6	Radial offset to vertical point on 3D axis
3	Measured point	7	Perpendicular offset to orthogonal point on 3D axis
4	Horizontal offset to 3D axis	8	Radial offset to orthogonal point on 3D axis

General Survey also reports the:

- ◆ distance from Point 1 and Point 2 to the calculated orthogonal point on the 3D axis
- ◆ distance from Point 1 and Point 2 to the calculated vertical point on the 3D axis
- ◆ coordinates and elevation for the calculated orthogonal and vertical points on the 3D axis

5. To store the measurement, enter a *Point name*, and a *Code*, if required, and then tap *Store*.

You can continue to measure and store additional points.

Tip - Tap *Back* to define a new 3D axis or to change the deltas display format.

Notes

- ◆ Descriptions and Attributes are not supported.
- ◆ The style sheet that you selected in *Measure / Measure 3D axes* is used when displaying 3D axes records in *Jobs / Review job*.
- ◆ If points 1 and 2 define a vertical axis, all vertical deltas show as null (?).

Dual-prism Offset

In a conventional survey, use this measurement method to coordinate a point that cannot be observed directly with a pole in a plumb position.

Note - The use of a tiltable prism with the appropriate nodal offset will give accurate results regardless of the direction of pole tilt. Prisms such as the Trimble VX/S Series 360° do not correct the vertical angle and slope distance for the difference between the optical center of the prism and the center line of the rod.

To measure a point using the dual-prism offset method:

1. As shown in the following diagram, space two prisms (A and B) apart on the range pole. The distance BC is known.
2. From the main menu, select *Measure* and then perform a [station setup](#) , [station setup plus](#) , [resection](#) , or [refline](#).
3. From the *Measure* menu, select *Measure topo*.
4. In the *Point name* field, enter the name of the point.
5. In the *Code* field, enter a feature code (optional).
6. In the *Method* field, select *Dual-prism offset*.
7. Complete the fields as required.

Tip - Enter a suitable *Tolerance AB* to generate a warning if there is a difference between the keyed-in distance AB between the two prisms and the measured distance AB between the two prisms. Exceeding the tolerance could indicate that the entered distance AB is incorrect, or it could indicate pole movement between the measurement to prism A and the measurement to prism B.

8. Take two measurements (tap *Measure*).

The General Survey software calculates the obscured position (C) and then stores it as a raw HA VA SD observation.

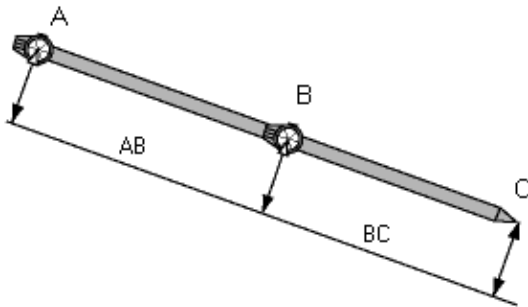

All raw observations are stored internally in the job file and are available in Custom ASCII Export.

Circular object

In a conventional survey, use this measurement method to calculate the center point of a circular object, such as a water tank or silo. To do this:

1. From the *Measure* menu, select *Measure topo*.
2. Use the *Circular object* method to measure an angle and distance to the front center face of the circular object.

There are two different workflows you can use to measure a circular object; Bisect tangents (default) and Center + tangent. To configure the method, tap the arrow or press the Shift key to access the second row of softkeys in the *Measure topo* screen, tap *Options*, and then specify the Circular object method.

3. Do one of the following:

- ◆ If you are using the bisect tangent method, you are prompted to point and measure an Angles only to the visible edges of the left and right sides of the circular object.

If the total station is motorized it automatically turns to the half angle between the Angles only measurements, and makes a DR measurement to a point on the circumference of the circular object. If the total station is not motorized you must turn the total station to the half angle so that it can complete the measurements. The two Angles only measurements and the third DR measurement are used to compute the radius of the circular object. The radius distance is added to the DR measurement and a raw HA VA SD observation to the center of the object is stored.

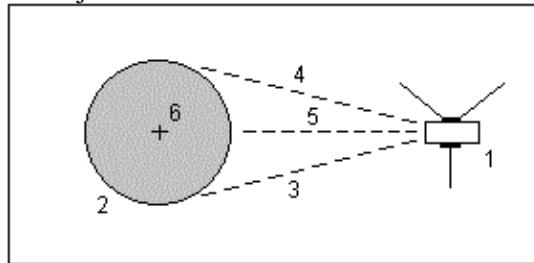

1	Total station	5	DR measurement
2	Circular object	6	Center of object
3 and 4	Angles only measurements	-	-

- ◆ If you are using the center + tangent method, measure an angle and distance to the front center face of the circular object, and then observe an angles only measurement to the side of the circular object.

From these two measurements, General Survey calculates the center point of the circular object and stores it as a raw HA VA SD observation. The radius is also calculated and stored with the observation.

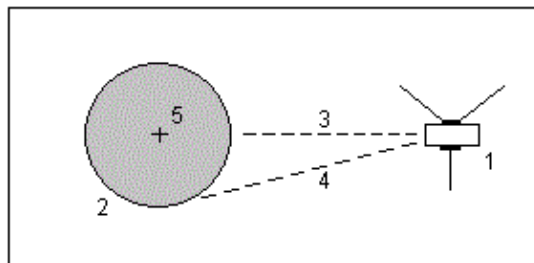

1	Total station	4	Angles only measurement
2	Circular object	5	Center of object
3	Angle and distance measurement	-	-

Measure Rounds

This topic describes how to measure multiple sets (rounds) of observations with a conventional instrument and the General Survey software.

A round can consist of one of the following:

- a set of single face 1 observations
- multiple sets of single face 1 observations
- a set of matched face 1 and face 2 observations
- multiple sets of matched face 1 and face 2 observations

Rounds can be used in a number of different ways depending on your equipment, the accessibility of points, and the procedures to observe the points, such as the order in which the observations are made.

To measure rounds of observations:

1. From the *Measure* menu, select *Measure rounds*.
2. Tap *Options* to [configure](#) the rounds options.
Before you start measuring points, make sure that the *Face order* and *Sets per point* settings are correct. You cannot change these settings after you start measuring points.
3. [Manually build the rounds list](#) by observing each point to include in the round on the first face.
4. Measure all points for subsequent rounds.
5. When all observations are complete, General Survey software shows the [Standard deviations screen](#).
6. Tap *Close* to save and exit rounds.

Notes

- When using servo or robotic instruments, check that the instrument has sighted the target accurately. Manually adjust it if necessary. Some instruments can perform accurate sighting automatically. For information on the instrument specifications, refer to the instrument manufacturer's documentation.
- Select [Interrupted target measurement](#) if the measurement is likely to be interrupted, for example, when measuring in traffic.
- If you measure to static targets when there are two prisms close together, use FineLock or Long Range FineLock technology.
 - ◆ With a Trimble S8 total station equipped with FineLock technology, you can use [FineLock](#) mode when measuring to a prism that is 20 m - 700 m away.
 - ◆ With a Trimble S8 total station equipped with Long Range FineLock technology, you can use [Long Range FineLock](#) mode when measuring to a prism that is 250 m - 2500 m away.
- If you are using a servo or robotic instrument to measure a known (coordinated) point, tap *Turn*. Alternatively, with a servo instrument, set the *Servo auto turn* field in the survey style to *HA & VA*, or *HA only* to automatically turn the instrument to the point.
- If you tap *Esc* in the *Measure* screen, the current round is discarded.
- The top of the Measure rounds screen shows the following:
 - ◆ the current face observations
 - ◆ when you use more than one set per point, the number of the current set and the total number of sets to be measured (shown in brackets)
 - ◆ the number of the current round the total number of rounds to be measured (shown in brackets)

For example, "Face 1 (2/2) (1/3)" shows that the instrument is on face 1 of the second set of two sets and the first of three rounds.

Building the rounds list manually

When you manually build the rounds list, the General Survey software automatically adds each point to the internal rounds list as it is measured for the first time. The rounds list contains all the information about each point such as point name, code, target height, prism constant, and target ID.

To manually add a point to the rounds list, and then measure rounds:

1. Choose to include or exclude the backsight observation.
See also [Including/excluding the backsight](#).
2. Follow the same procedure as for [measuring a topo point](#).

Note - To specify the prism constant or the height of the target for each observation in the rounds list, tap the target icon. If the prism constant is to be subtracted from measured distances, enter a negative value. You cannot alter the prism constant or the target height for subsequent rounds. Instead, General Survey uses those values stored when building the rounds list.

3. When the rounds list is built, tap *End Face*. The General Survey software:
 - ◆ Defaults to the correct point details for each observed point.
 - ◆ Directs you to change face when required. With a servo-driven instrument, this happens automatically.
 - ◆ Automatically turns and measures when using [Autolock](#) or [FineLock](#) technology, and [Automated rounds](#) is enabled.
 - ◆ Displays the results. You can then delete bad data as required.

Notes

- You cannot add the same point to the rounds list more than once. To take more measurements to points already measured, tap *End face*.
- You cannot edit the rounds list. Before you tap *End face*, be sure to observe all points to include in the rounds observations.
- When measuring a DR target with a Trimble VX Spatial Station or Trimble S Series total station with automated rounds, the General Survey software will pause to allow you to sight to the target. You **must** manually sight and measure the point to continue.

Include/exclude the backsight from a set of rounds

- Trimble recommends observing the backsight on both faces if you are taking foresight observations on both faces.
If you exclude the backsight:
 - ◆ the backsight observation(s) taken during the station setup is used to compute the MTA.
 - ◆ if you do not measure the backsight on face 2 and there is only one single face observation to the backsight, and the rounds include observations on both faces, then the horizontal angle face 2 measurements observed using *Measure rounds* will not be used when calculating the MTAs.

Rounds - maximum number

The following limits apply in rounds:

- rounds - maximum 100
- points per round - maximum 200
- sets per point within each round - maximum 10

Even though the maximum limits set in the General Survey software are generous, the limit on how many points you can observe depends on the memory available on the controller. For example, you could measure 100 rounds to 10 points, or 10 rounds to 200 points, but memory limits preclude measuring 100 rounds to 200 points.

For more details see:

- [Standard Deviations screen](#)
- [Point - Residuals screen](#)
- [Point details screen](#)
- [FineLock](#)
- [Face order](#)
- [Observation order](#)
- [Sets per point](#)
- [Number of rounds](#)
- [Skipping observations](#)
- [Automated rounds](#)
- [Monitoring](#)

Standard deviations screen

At the end of each round, the *Standard deviations* screen appears. This screen shows the Standard deviations of each point in the rounds list.

Do one of the following:

- To observe another round, tap + *Round*.
- To store the current rounds session, tap *Close*.
- To view/edit the Details of a point, highlight the point and then tap *Details*.
- To view or edit the residuals of each individual observation to a point, tap the point in the list once.
- If you have enabled a measured point to be added to a CSV file, select the *Add to CSV file* option. The point will be stored in the displayed file name. To enable adding a file, see: [Add to CSV File](#).
- To exit from rounds and delete all rounds observations, tap *Esc*.

Notes

- Each individual round is stored to the job only when you tap *Close* or + *Round* to exit the *Standard deviations* screen.
- To change the rounds configuration settings, tap *Options*.

Tips

- To highlight an item in a list, tap and hold the item for at least half a second.

- To sort a column in ascending or descending order, tap the column header. Tap the *Point* column header to sort the point in ascending or descending observed order.
- To change the residual display view, select an option from the drop-down list in the *Residuals* screen.

Point - Residuals screen

The *Point residuals* screen shows the differences between the mean observed position and the individual observations to a particular point.

Do one of the following:

- To disable an observation, highlight it and then tap *Use*.
- To view the details of an observation, highlight it and then tap *Details*.
- To return to the *Standard deviations* screen, tap *Back*.

Notes

- If you have measured face 1 and face 2 observations to a point, when you disable the observation for one face, the corresponding observation on the opposite face is automatically disabled.
- Whenever you make a change in the *Point residuals* screen, the mean observations, residuals, and standard deviations are recalculated.
- If the current station setup has a single backsight only, the *Use* softkey is not available for observations to the backsight. Observations to the backsight are used to orientate observations and cannot be deleted.
- If you remove observations, the  icon appears. If you skipped observations in a round, no icon appears.

Tip - If the residuals for an observation are high, it may be better to disable the observation from the round.

Point details screen

The *Point details* screen shows the mean observation details for a particular point.

Remote Object

In a conventional survey, if the instrument does not support DR mode, or if you cannot measure a distance, use this method to calculate the height and/or width of a remote object. See the following diagram.

1. Start a conventional survey.
2. Select *Measure / Measure Topo / Remote object*.
3. Measure an angle and distance to the bottom of the remote object (1).
4. Set the method as required.
5. Sight to the Remote point (2).
6. Tap *Store* to store the observation.
7. To make multiple remote object observations, repeat steps 5 and 6.

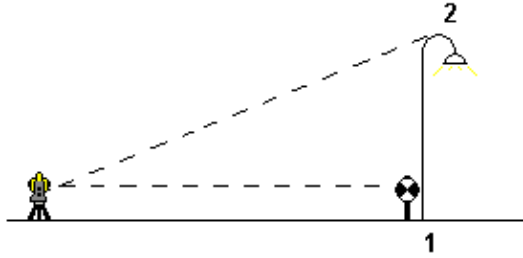

Using the first measurement and continuous HA VA angles, General Survey calculates the position of the remote object, showing the width and elevation difference from the base point. The observation to the base of the remote object is stored as an HA, VA, SD. The Remote point is stored as an HA, VA with a computed SD, including the Object height and Object width.

Scanning

Surface scanning is an automated direct reflex (DR) measuring process where measurements are automatically stored along a remote surface that you have defined.

Notes

- The Scanning option is available only when connected to a Trimble VX Spatial Station.
- Scanning is not available when the General Survey software is connected through Bluetooth wireless technology.
- Scanning is not available when the General Survey software is connected through a serial cable connection.

For more details, see:



- [Starting a scan](#)
- [Progress information](#)
- [Ending a scan](#)
- [White balance](#)

Starting a scan



To perform a scan using General Survey:

1. From the *Measure* menu, select *Scanning*.
2. Define the area for the scan. Use one of the following methods, and see below for preset buttons that you can use.

Polygon framing:

1. If  is displayed, tap  to set the Polygon framing mode.
2. Tap on the video screen to define the first corner of the polygon.
3. Tap again on the video screen to define the second vertex. You must enter at least three vertices to define a polygon scan frame.
4. If required, drag-and-drop the last vertex to move it, or select the vertex and then tap undo () to remove it. You can do this only with the last vertex.

Rectangular framing:

1. If  is displayed, tap  to set the Rectangular framing mode.
2. Tap on the video screen to define the first corner of the scan rectangle.
3. Tap again on the video screen to define the opposite corner of the scan area.
4. If required, drag-and-drop the vertices, or click and drag the sides of the scan frame to resize the scan rectangle.
3. Define the point density for the scan area:
 - a. Tap scan properties ().
 - b. Define the scan properties. Select one of the following methods:
 - ◇ Horizontal and vertical distance interval at a given distance
 - ◇ Horizontal and vertical angle interval
 - ◇ Total number of points in the scan
 - ◇ Time to complete
 - c. Enter the parameters to define the scan density.
4. Select the *Scanning mode*:
 - ◆ *High speed* scans up to 15 points per second to a maximum range of about 150 m.
 - ◆ *Long range (TRK)* scans with the EDM in TRK mode and scans up to 2 points per second to a maximum range of about 300 m.
 - ◆ *Long range (STD)* scans with the EDM in STD mode and scans up to 1 point per second to a maximum range of about 300 m.
5. Specify the *EDM timeout*.
6. Tap *Start*.





Notes

- The camera is not coaxial with the telescope. For accurate framing at close range, define the *At distance* setting, which helps to draw the scanning frame in the correct position.
- The time to complete a scan is an estimate only. Actual scan times will vary depending on the surface or object being scanned.
- Scan time is increased if there are areas within the scan that will not return an EDM signal. Where possible, try to minimize blank space in the scan area.
- Higher speed scans can result in more skipped points. Select a scanning mode appropriate to the object you are scanning.
- Defining the scanning grid through distance intervals assumes that the scanning object is a constant distance from the instrument. In other cases, the scan points will not constitute an even grid.
- When you perform a scan with the Trimble VX Spatial Station through a robotic connection, Trimble recommends that you stay within the range of the radio link to ensure that all necessary data is collected successfully. If you lose the radio link, the remainder of the current scan line will be skipped.



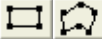



- You can scan a full 360° horizontally. The vertical range is approximately between 3°36' (4 gon) and 150° (166 gon).
- Make sure that the *Maximum distance* that you configured in *Instrument / EDM Settings* is set high enough to achieve the required scanning range.
- When using long range scanning mode, intensity information is not available and is not saved to the .tsf file.

You can use the preset buttons to help you define the scan area.

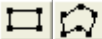
These preset buttons are available for Polygon framing:







Softkey	Function
	Toggles between rectangular and polygon framing mode.
	When selected, the polygon framed area is shaded red.
	Deletes the scan frame from the screen. When the 'cross' is grey, the delete function is not available.
	Undoes the previous vertex. When the 'arrow' is grey, the undo function is not available.

These preset buttons available for Rectangular framing:

Softkey	Function
	Toggles between rectangular and polygon framing mode.
	Toggles between the current frame and the complement of the current frame. Tap this button to change the horizontal extents of the scan so that the horizontal scan area is the opposite of the original frame; it is the larger part of the horizontal circle. The vertical extents of the scan area do not change.
	Toggles between the current frame and the complement of the current frame. Tap this button to change the horizontal extents of the scan so that the horizontal scan area is the original frame; it is the smaller part of the horizontal circle. The vertical extents of the scan area do not change.
	Automatically defines a rectangle from the highest to lowest vertical angles in the current horizontal position. To resize the scan frame, drag one of its sides or vertices. This is useful for quick-framing an object (for example, a facade), in front of the instrument.
	Automatically defines a large horizontal rectangle through the majority of the horizontal circle. To resize the scan frame, drag one of its sides or vertices. This is useful for quick-framing an object that surrounds the instrument.
	Deletes the scan frame from the screen. When the 'cross' is grey, the delete function is not available.
	Undoes the previous vertex. When the 'arrow' is grey, the undo function is not available.





You can capture the image displayed in the video frame of the scanning window.

Softkey	Function
	Links to the <i>Scan Properties</i> form where you can define the parameters of the scan. You can define the density of scan points within the frame area by distance intervals, angle intervals, the total

	number of points, or the scan time. You can also select the Scanning mode and specify the EDM timeout.
	Controls the brightness of the video image on the controller screen and consequent captured images.
	Controls the contrast of the video image on the controller screen and consequent captured images.
	Controls the level of white balance in the video image on the controller screen and consequent captured images.
	Set the file name. File names are automatically incremented from the start file name.
	Set the image size. The image captured is always the same as the video display on screen. Not all image sizes are available at all zoom levels.
	Set the compression of the image. The higher the quality of the image, the larger the file size of the captured image.
	Captures an extra large (XL) image (2048x1536). XL is available only when zoomed to extents 1:1.
	Captures a large (L) image (1024x768). L is available only when zoomed out to extents 1:1 and 2:1.
	Captures a medium (M) image (512x384). M is available only when zoomed in to 1:1, 2:1, and 4:1.
	Captures a small (S) image (256x192). S is available regardless of the zoom level.
	Launches the <i>Panorama</i> function where you can automatically capture multiple images for a defined scan frame. Define the <i>Image size</i> and <i>Compression</i> , enable <i>Fixed exposure</i> to fix the exposure to the settings at the time you tap <i>Start</i> , define the <i>Image overlap</i> and then tap <i>Start</i> to begin taking the images.

Tip - The exposure is fixed when you select *Start*. When using the *Panorama* function with *Fixed exposure* enabled, point the Trimble VX Spatial Station to the location that defines the camera exposure that you want used for all panoramic images and then tap *Start*.

You can navigate/zoom around the video frame in the scanning window. The navigation controls are as follows.

Softkey	Function
	Zoom in. There are four levels of zoom available in the video window.
	Zoom out. There are four levels of zoom available in the video window.
	Activate tap-and-move functionality in the video window.
	Zoom out to the full extents.
Options	<i>Display point clouds</i> controls the option to display the point cloud over the scan.
	<i>Color</i> controls the color of the point cloud.
	<i>Point size</i> controls the width of the pixel displayed in the point cloud.

Point cloud color

Color	Show points...
Cloud color	with the color of the clouds they belong to
Station color	with the color of the stations they belong to
Scan color	with the color of the scans they belong to

Grey scale intensity	using the gray scale defined by their intensity
Color coded intensity	using the color encoded intensity

Progress information

During a scan, progress information appears in the scanning window. For every point in the scan, a colored square appears on screen.

- The color of the square indicates the measured distance to the point. A nearby point is red, compared to a point further away which is blue.
- The brightness of the square indicates the intensity of the returned EDM signal. The brighter the square, the better (more intense) the signal.
- A black square indicates that no measurement was able to be taken at that location.
- The size of the squares depends upon the number of points in the scan. The smaller the square, the more points in the scan. When the scan is completed, the points will cover the maximum possible area; so a tall, narrow scan area, that does not fit the screen size well, appears with black strips on each side of the drawn scan points.

The status line provides progress information on:

- The percentage of scan completed.
- The number of points scanned.
- The estimated time remaining. This is updated as the scan progresses to reflect the current scan speed and is dependant on the surface of the object in the scan.

While a scan is in progress:

- You cannot edit scan properties. To view the properties, tap the scan properties button.
- Other instrument/survey functions are disabled. If you need to access a survey or instrument function during a scan, you must pause the scan, perform the operation and then continue the scan.
- You cannot access the video window. You must first complete the scan and then close the scanning window.

Ending a scan

When the scan is completed, the *Pause / Continue* softkey changes to *Finish*. Tap *Finish* or *Esc* to end the scan.

To cancel a scan that is in progress, tap *Esc* and then tap *yes*. The scanning record and associated TSF file will still be written if you manually cancel a scan.

Notes

- Scanned points are not stored in the General Survey job file; they are written to a TSF file that is stored in the current [project folder](#).
- If a scan contains over 100,000 points, the points will not appear in the map or in point manager.
- You can import the General Survey JOB or JXL file into the Trimble RealWorks Survey software. If

associated TSF and JPEG files are stored in the same [project folder](#) as the JOB or JXL file, they are imported at the same time.

- When creating DC files, either on the controller or when downloading the file with office software such as Trimble Geomatics Office or the Trimble Data Transfer utility, the data from the TSF file(s) associated with the job is inserted into the DC file as regular conventional observations.
- To transfer JPEG files from the Trimble CU in the docking station to the office computer, use the USB-to-Hirose cable.
You cannot use the DB9-to-Hirose serial cable to transfer JPEG files.
- Once the scan is completed, the name of the scan file, and the scan properties, are stored in the General Survey job file.

Tips

- When a scan is completed or cancelled, the last used frame area is retained in the scanning video window. To rescan the same area, edit the scan properties (if required) and then tap *Start*.

Surface Scan

Surface scanning is an automated direct reflex (DR) measuring process where measurements are automatically stored along a remote surface that you have defined.

To perform a surface scan using General Survey:

1. From the *Survey* menu, select *Surface scan*.
2. Enter the *Start point name* and *code* (if necessary).
3. In the *Method* field, select a measurement method.
4. Define the area for the scan and grid interval.
5. Tap the instrument icon to access Instrument functions and set the EDM measurement method (TRK is fastest).

The total number of points to scan, scan grid dimensions, and estimated scan time are displayed. Change the scan size, step sizes or EDM measurement method to increase or decrease the number of points and scan time.

6. Tap *Start*.

To define the scan area, do one of the following:

- If the point already exists, enter the point name, or use menu arrow to select it from the list.
- From the pop-up menu in the *Top left* and *Bottom right* fields select *Fast fix* or *Measure* to measure and store points that define the limits of the search.

Define the scan area with one of the following methods.

HA VA interval - Use this method on complex surfaces when you cannot use a rectangular plane to approximate the surface you are scanning (see the following diagram):

1. Aim to the top left corner of the scan area (1) and measure a point.
2. Aim to the bottom right corner of the scan area (2) and measure another point.
3. Define the angular grid interval, where:
 - 3 is the Horizontal angle
 - 4 is the Vertical angle

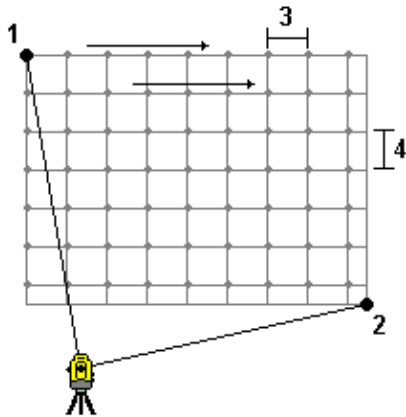

Tip - To define a Horizontal only scan of a 360° scan area, set the Top left and Bottom right points to the same name, and set the VA interval to null.

Rectangular plane - Use this method on a plane surface where you need a regular grid interval. General Survey determines the angle of the plane, and uses this and the grid interval to approximate how far to turn the instrument for each subsequent point (see the following diagram):

1. Aim to the first corner of the scan area (1) and measure a point.
2. Aim to the second corner of the scan area (2) and measure another point.
3. Aim to the third point on the opposite side of the plane (3) and measure a point.
4. Define the distance grid interval, where:
 - 4 is the Horizontal distance
 - 5 is the Vertical distance

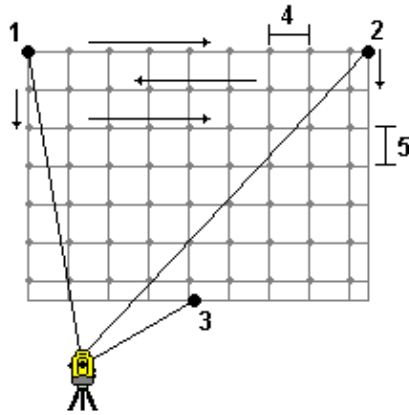

Line and offset - Use this method to define the area to scan from a center line that has equal offsets to the left and right. General Survey defines the surface using horizontal offsets perpendicular to the center line. The software then uses this definition and the station interval to determine approximately how far to turn the instrument for each subsequent point (see the following diagram):

1. Do one of the following:

- Two point method:

1. Aim to the start point of the center line (1) and measure a point.
2. Aim to the end point of the center line (2) and measure another point. These two points (1 and 2) define the center line.

- Access the pop-up menu in the *Start point* field. Change the method and then define the line by a start point with azimuth and length.

2. Define the station interval (3).
3. Define the maximum offset distance (4).
4. Define the offset interval (5).

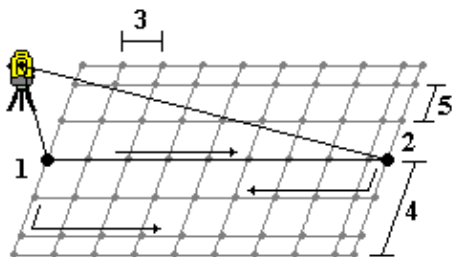

General Survey scans the center line first, then the points on the right-hand side, and finally the left-hand side.

Note - With all of the above methods, the defined scan area may not exactly fit the grid interval. There may be an area left over along the scan extents that is smaller than the grid interval. If the width of this area is less than one-fifth of the grid interval, the points along this scan area will not be measured. If the width is more than one-fifth of the grid interval, then an extra point is scanned.

Check Point

In a conventional survey, tap *Check* to measure a check class point.

To measure a check point:

1. In the *Point name* field, enter the name of the point to check.
2. In the *Method* field, select a measurement method and enter the required information in the fields that appear.
3. In the *Target height* field, enter the height of the target and then tap *Measure*.

When measuring to the bottom notch on a [Trimble prism base](#), tap the advanced pop-up arrow () and then select *Bottom notch*.

If you did not select the *View before storage* check box, the point is stored with a classification of *Check*. If you selected the *View before storage* check box, the check shot deltas appear on the *Check shot* screen.

When you observe the point, if the station setup is the same as when you originally measured the point, the deltas are the difference in values between the original observation and the check observation. The deltas displayed are horizontal angle, vertical distance, horizontal distance, and slope distance.

If the station setup is different from when you originally measured the point, the deltas are in terms of the best coordinates from the original point to the check point. The deltas displayed are azimuth, vertical distance, horizontal distance, and slope distance.

4. Tap *Enter* to store the check point. Tap *Esc* to abandon the measurement.

Tap *Chk BS* to display the *Check backsight* screen. This is similar to the *Check point* screen, but the *Point name* field shows the backsight of the current station setup. You cannot edit this field.

To observe a check shot to the backsight, use the same procedure as described above.

To return to the *Check point* screen, tap *Chk topo*.

Tip - During a conventional survey, you can use the tap and hold menu in the map to quickly measure a check point. If there are no points selected, *Check backsight* is available; if one point is selected *Check shot* is available.

Alternatively, to measure a check shot from any screen, press [CTRL + K] on the controller.

Fast Fix

Tap *Fast fix* to quickly measure and automatically store a construction point. Alternatively, select *Fast fix* from the pop-up menu in the *Point name* field.

Note - In a conventional survey, *Fast fix* uses the current measurement mode. If you need more flexibility, select *Measure* from the pop-up menu in the *Point name* field.

Typically, a construction point is used in *Cogo - compute points* or *Key in - lines and arcs*.

Construction points are stored in the General Survey database with autopoint names that increment from Temp0000. They are classified higher than check points and lower than normal points. For more information, see [Database Search Rules](#).

To view construction points in a map or list, tap *Filter* and select them from the *Select filter* list.

Survey - Stakeout

Stakeout - Configuring the Display Mode

Conventional Surveys

For a conventional survey the *Stakeout graphical display* screen displays directions using the conventional instrument as a reference point.

For a conventional survey, you can configure the *Stakeout directions* and the *Display mode* of the *Stakeout graphical display*.

Offset & Stakeout directions allows you to configure the stakeout directions to be from an instrument perspective, target perspective, or automatic. *Automatic* configuration sets the stakeout directions automatically, based on whether you have a servo connection or a robotic connection to the instrument:

Display mode allows you to configure the graphical navigation display.

When the *Display mode* is set to *Direction and distance*, the navigation screen displays:

- ◆ A large arrow pointing in the direction you have to move. When you are close to the point, the arrow changes to the in/out and left/right directions, relative to the instrument.

When the *Display mode* is set to *In/out and left/right*, the navigation screen displays:

- ◆ In/out and left/right directions, with the conventional instrument as a reference point.

To configure the display:

1. From the Trimble Access menu, tap *Settings / Survey styles / <Style name> / Instrument*.
2. Set the *Offset & Stakeout directions*:
 - ◆ Automatic - navigation directions are from *Instrument perspective* (during a servo connection), or *Target perspective* (during a robotic survey).
 - ◆ Instrument perspective (standing behind the instrument) - in/out and left/right navigation directions given from an instrument perspective, looking from the instrument towards the target.
 - ◆ Target perspective (standing at the target) - in/out and left/right navigation directions given from a target perspective, looking from the target towards the instrument.
3. Tap *Accept*, and then select *Stakeout*.
4. Set the *Display mode*:
 - ◆ Direction and distance - navigate using the large arrow, similar to GNSS stakeout. When you are close to the point, the display automatically changes to the in/out and left/right display.
 - ◆ In/out and left/right - navigate using in/out and left/right directions, with the instrument as a reference point.

5. Choose a setting in the *Deltas (points)* and *Deltas (other)* fields. The two deltas fields allow you to configure one deltas default for point stakeout, and the other deltas default for arc, line, alignment and road stakeout.

- ◆ Distances - navigate to a point using distances only
- ◆ Delta grid - navigate to a point using delta grid values
- ◆ Station and offset - navigate to a point using station and offset when staking a line or arc.

When staking to the line or arc the station and offset view displays the Station, H.offset, V.Distance and the Grade.

When staking to the Station on the line / arc or the Station/offset from line / arc the view displays the Station, H.offset, V.dist, delta Station and delta H.offset.

6. Use the *Distance tolerance* field to specify the allowable error in distance. If the target is within this distance from the point, the graphical stakeout display indicates that the distance(s) is correct.
7. Use the *Angle tolerance* field to specify the allowable error in angle. If the conventional instrument is turned away from the point by less than this angle, the graphical stakeout display indicates that the angle is correct.
8. If a DTM file has been transferred into the General Survey software, you can select the *Display cut/fill to DTM* check box, and the graphical display screen will display the cut or fill relative to that DTM. Use the *DTM* field to specify the name of the DTM to be used. If necessary, specify a vertical offset to raise or lower the DTM.

Alternatively, tap *Options* from the *Stakeout* screen to configure the settings for the current survey.

Notes

5. If a DTM file has been transferred into the General Survey software, you can select the *Display cut/fill to DTM* check box, and the graphical display screen will display the cut or fill relative to that DTM. Use the *DTM* field to specify the name of the DTM to be used. If necessary, specify a vertical offset to raise or lower the DTM.

Stakeout - Using the Graphical Display

The graphical display in *Stakeout* helps you to navigate to a point.

Tip - If navigating with a TSC3 or Trimble Slate Controller you can use the internal compass to aid navigation. See [Compass](#) for further details.

Conventional

To use the graphical display in a conventional survey:

If you are using the *Direction and distance* mode:

1. Hold the display screen in front of you as you walk forwards in the direction that the arrow is

- pointing. The arrow points in the direction of the point.
2. When you get to within 3 meters (10 feet) of the point, the arrow disappears, and the in/out and left/right directions appear, with the instrument as a reference point. Follow the instructions below to navigate in this mode.

If you are using the *In/out and left/right* mode:

1. The first display shows which way the instrument should be turned, the angle that the instrument should display and the distance from the last point staked to the point currently being staked.
2. Turn the instrument (two outline arrows will appear when it is on line), and direct the rod person on line.

If you are using a servo instrument, and the *Servo auto turn* field in the survey style is set to *HA & VA*, or *HA only* the instrument automatically turns to the point.

If you are working robotically, or when the *Servo auto turn* field in the survey style is set to *Off*, the instrument does not turn automatically. To turn the instrument to the angle indicated on the screen, tap *Turn*.

3. If the instrument is not in *TRK* mode, tap *Measure* to take a distance measurement.
4. The display shows how far the person holding the rod should move towards or away from the instrument.
5. Direct the person holding the rod, and take another distance measurement.
6. Repeat steps 2 - 5 until the point has been located (when four outline arrows are displayed), then mark the point.
7. If a measurement to the target is within the angular and distance tolerances, tap *Store* at any time to accept the current measurement.

If the instrument is in *TRK* mode and you require a higher precision distance measurement, tap *Measure* to take an *STD* measurement and then tap *Store* to accept that measurement. To discard the *STD* measurement and return the instrument to *TRK* mode, tap *Esc*.

If you are operating a robotic instrument remotely from the target:

- ◆ the instrument automatically tracks the prism as it moves
- ◆ the instrument continuously updates the graphical display
- ◆ the graphical display is reversed and the arrows are shown from the target (prism) to the instrument

Note - When the *Display orientation* is set to *Direction of travel*:

Stakeout - Options

Configure the stakeout settings when you create or edit a Survey Style.

Select *Stakeout* and set the *As-staked point details* , and *Stakeout display mode*.

If you do not want the total station EDM set to *TRK* mode when you enter stakeout, clear the *Use TRK for stakeout* check box.

Alternatively, tap *Options* from the *Stakeout* screen to configure the settings for the current survey.

If you do not want the point removed from the stake out point list after it has been staked, clear the *Remove staked point from list* check box.

Tap *Options* from the *Stakeout* screen to enable / disable the internal *compass*, when using a TSC3 or Trimble Slate Controller.

As-Staked Point Details

Configure the *As-staked point* details either in the *Stakeout* option, when you create or edit a survey style, or by tapping *Options* in the *Stakeout* screen.

You can configure the *View before storage* , *Horizontal tolerance* , *Staked deltas format* , *As-staked name* , *As-staked code* , and *Store grid deltas*.

View before storage and Horizontal tolerance

If you want to see the differences between the design point and the as-staked point before you store the point, select the *View before storage* check box and then choose one of these options:

- To see the differences every time, set the Horizontal tolerance to 0.000 m.
- To see the differences only if the tolerance is exceeded, set the Horizontal tolerance to a suitable value.

Note - The *Stake delta* values are reported as differences *from* the measured/as-staked point *to* the design point.

User definable stakeout reports

The General Survey software supports user-definable stakeout reports, which enable you to configure the display of staked information on the *Confirm staked deltas* screen that appears when you enable *View before storage*.

User definable stakeout reports can offer the following benefits:

- important information can be displayed first
- the data can be ordered to suit the user's requirements
- information that is not required can be removed
- additional data can be computed for display, for example by applying construction offsets to reported values
- the point design elevation can be edited after the stake out measurement is completed
- up to 10 extra design elevations with individual vertical offset values can be defined and edited, with

the cut/fill to each extra design elevation being reported

Formatting of the staked deltas screen also supports the following settings:

- the size of the font for prompts
- the size of the font for reported values
- the color of the font for prompts
- the color of the font for reported values
- widescreen on or off

The content and format of the stakeout reports is controlled by XSLT style sheets. Translated default XSLT Stakeout Style Sheet (*.sss) files are included with the language files, and accessed by the General Survey software from the language folders. You can create new formats in the office and then copy them to the [System files] folder on the controller.

From the *Staked deltas format* field, select an appropriate display format.

The following list shows the translated stakeout reports that are supplied with the language files, and the support offered by those reports:

- Point - Stake markup
 - ◆ Provides a simplified stakeout display that presents the vertical distance (cut/fill) to the design point. The vertical distance to a DTM will also be displayed if applicable.
- Point - Stake multiple elevs
 - ◆ Provides a stakeout display that allows you to edit the point design elevation (the cut/fill value will be updated) and entry of up to two extra design elevations with associated vertical offsets and updated cut/fill values.
- Line - Stake markup
 - ◆ Provides a simplified stakeout display that presents the vertical distance (cut/fill) to the design position. The appropriate station and offset values are reported, based on the selected line stakeout method.

As-staked name and As-staked code

You can set the **name** of the As-staked point to be one of the following:

- the next *Auto point name*
- the *Design point name* (not available for roads)

You can also set the **code** of the As-staked point to be one of the following:

- *Design name*
- *Design code*
- *Last code used*
- *Design station and offset*

Store grid deltas

Set the *Store grid deltas* check box. Do one of the following:

- Select the check box to display and store the delta northing, delta easting, and delta elevation during stakeout.
- Clear the check box to display and store the deltas as a horizontal distance, vertical distance, and azimuth.

Note - If you use a user definable stakeout report, the *Store grid deltas* option is not used, unless it is referenced in your report.

Stakeout - Points

There are many ways to stake a point. Select the method that suits you best:

- From the [Map - single point](#)
- From the [Map - using a list](#)
- From [Stakeout / Points - single point](#)
- From [Stakeout / Points - using a list](#)
- From [Stakeout / Points - using a CSV/TXT file](#)

For more information, see:

- [Editing the design elevation](#)

To stake a single point from the Map:

1. From the map, do one of the following:
 - ◆ Select the point to be staked out and then tap *Stakeout*.
 - ◆ Double-tap the point to be staked.
- In a conventional survey:
 - ◆ To change the target height, tap the target icon in the status bar, tap the antenna height field and then enter the new value in the screen that appears. Tap *Accept*.
3. Use the [graphical display](#) to navigate to the point.

If required, [edit the design elevation](#).
4. When the point is within tolerance, measure the point.
5. When the point has been stored, you are returned to the map. The selection of the point that was just staked has been removed. Select another point to stake and then repeat the process.

To stake a group of points from the Map:

1. From the map, select the point(s) to be staked out. Tap *Stakeout*.

- If you have selected more than one point from the map for staking out, the *Stake out points* screen appears. Go to the next step. If you have selected one point from the map, go to step 4.
2. The *Stake out points* screen lists all points selected for stakeout. To add more points to the list, do one of the following:
 - ◆ Tap *Map* and then select the required points from the map. Tap *Stakeout* to return to the *Stake out points* screen.
 - ◆ Tap *Add* and then add points using one of the [methods listed](#) to add more points to the list.
 3. To select a point for stake out, do one of the following:
 - ◆ Tap the point name.
 - ◆ Use the controller arrow keys to highlight the point and then tap *Stakeout*.
 - In a conventional survey:
 - ◆ To change the target height, tap the target icon in the status bar, tap the antenna height field and then enter the new value in the screen that appears. Tap *Accept*.
 5. Use the [graphical display](#) to navigate to the point.

If required, [edit the design elevation](#).
 6. When the point is within tolerance measure the point.
 7. When the point has been stored, the point is removed from the stake out list and you are returned to the stake out point list. Select the next point and then repeat the process.

To stake a single point from the Stakeout menu:

1. From the main menu, select *Stakeout / Points*.
2. Make sure that you are in the stake a single point mode:
 - ◆ If a *Point name* field is displayed, stake out point is in the stake a single point mode.
 - ◆ If a stake out point list is displayed, stake out point is in the stake from a list mode. Tap > *Point* to change to the stake a single point mode.
3. Enter the name of the point to stake, or tap the pop-up arrow and then select a point using one of the following methods:

Method	Description
List	Select from a list of all points in the current job and linked files.
Wildcard search	Select from a filtered list of all points in the current job and linked files.
Key in	Key in the coordinates of the point to stake.

Tip - Tap *Closest* to automatically populate the *Point name* field with the name of the closest point. *Closest* searches the current job and all linked files to find the closest point that is **not** an as-staked point or a design point for the as-staked points.

4. Enter the *Point increment* and then tap *Stakeout*. Do one of the following:
 - ◆ To return to the stake out point screen after staking a point, enter an increment of 0 or ?.

- ◆ To stay in the graphical stake out display and automatically increment to the next point, enter a valid increment value.

If a point does not exist using the increment specified, tap *Cancel* to return to this form after staking a point. Alternatively, tap the *Search* button to find the next available point.

You can use a decimal point increment, for example 0.5. You can also increment the numeric component of a point name that ends in alpha characters, for example, you can increment 1000a by 1 to 1001a. To do this, tap the advanced pop-up arrow on the point increment field and then clear the *Apply to numeric only* setting.

- In a conventional survey:
 - ◆ To change the target height, tap the target icon in the status bar, tap the antenna height field and then enter the new value in the screen that appears. Tap *Accept*.

6. Use the [graphical display](#) to navigate to the point.

If required, [edit the design elevation](#).

7. When the point is within tolerance measure the point.

8. When the point has been stored, the increment value is used to determine the next point to stake:

- ◆ If the next point using the increment value exists, you remain in the stake out graphics screen with the navigation details updated for the next point.
- ◆ If the next point does not exist, tap *Cancel* to return to the stake out point screen where you can enter the name of the next point to stake. Alternatively, tap the *Search* button to find the next available point.

Tip - When using stake a single point mode, you can still use a stake point list to ensure that you stake all required points. To do this, build the stake list, make sure that *Remove staked point from list* is enabled, and stake points using the stake a single point mode. As points are staked they will be removed from the stake list. Tap > *List* as required to check which points still need to be staked.

To stake a group of points from the stake out menu:

1. From the main menu, select *Stakeout / Points*.
2. Make sure that you are in the stake out list mode:
 - ◆ If a stake out point list is displayed, stake out point is in the stake from a list mode.
 - ◆ If a *Point name* field is displayed, stake out point is in the stake a single point mode. Tap > *List* to change to the stake from a list mode.
3. The *Stake out points* screen lists all points selected for stake out. The list may already contain points that were added to the list previously but not staked out.

Tap *Add* and add points using one of the [methods listed](#) to add more points to the list.

4. To select a point for stake out, do one of the following:
 - ◆ Tap the point name.
 - ◆ Use the controller arrow keys to highlight the point and then tap *Stakeout*.

- In a conventional survey:
 - ◆ To change the target height, tap the target icon in the status bar, tap the antenna height field and then enter the new value in the screen that appears. Tap *Accept*.
- 6. Use the [graphical display](#) to navigate to the point.

If required, [edit the design elevation](#).
- 7. When the point is within tolerance measure the point.
- 8. When the point has been stored, the point is removed from the stake out list and you are returned to the stake out point list. Select the next point and then repeat the process.

To stake out points from a CSV/TXT file or another Job

There are many ways to stake out points in a linked file; from linked points displayed in the [map](#), or using various methods to [build a stake out list](#).

This section describes how to build a stake out list from a CSV/TXT or Job file that does not need to be linked:

1. From the main menu, select *Stakeout / Points*.
2. Make sure that you are in the stake out list mode:
 - ◆ If a stake out point list is displayed, stake out point is in the stake from a list mode.
 - ◆ If a *Point name* field is displayed, stake out point is in the stake a single point mode. Tap *> List* to change to the stake from a list mode.
3. Tap add and choose *Select from file*.
4. Choose the file from which to select points to add to the stake out list. Do one of the following:
 - ◆ Tap the file.
 - ◆ Use the controller arrow keys to highlight the file and then tap *Accept*.
5. If [Advanced geodetics](#) is enabled, and you select a CSV or TXT file, you must specify if the points in the linked file are Grid points or Grid (local) points.
 - ◆ Select *Grid points* if the points in the CSV/TXT file are grid points.
 - ◆ Select *Grid (local) points* if the points in the CSV/TXT file are Grid (local) points and then select the input transformation to transform them to grid points.
 - ◇ To assign the transformation later, select *Not applied, this will be defined later*, and then tap *Accept*.
 - ◇ To create a new display transformation, select *Create new transformation*, tap *Next* and then complete the [required steps](#).
 - ◇ To select an existing display transformation, select *Select transformation*, select the display transformation from the list and then tap *Accept*.
6. All the points in the selected file are listed. To check the points that are to be added to the list, do one of the following:
 - ◆ Tap *All*. A check mark appears beside every name.
 - ◆ Tap the point names. A check mark appears beside the name of each point that you selected.

Note - Points in the CSV/TXT/JOB file that are already in the stake out list do not appear and cannot be added again to the list.

7. Tap *Add* to add the points to the stake out list.
8. To select a point for stake out, do one of the following:
 - ◆ Tap the point name.
 - ◆ Use the controller arrow keys to highlight the point and then tap *Stakeout*.
- In a conventional survey:
 - ◆ To change the target height, tap the target icon in the status bar, tap the antenna height field and then enter the new value in the screen that appears. Tap *Accept*.
10. Use the [graphical display](#) to navigate to the point.

If required, [edit the design elevation](#).
11. When the point is within tolerance measure the point.
12. When the point has been stored, the point is removed from the stake out list and you are returned to the stake out point list. Select the next point and then repeat the process.

Notes

- The cross-track function creates a line between the point to be staked out and one of the following: a fixed point, the start position, the last point staked, or a reference azimuth. The General Survey software displays this line, and an extra field (*Go left* or *Go right*), in the graphical stake out screen gives the offset to the line.
- When the *Deltas* field is set to Station and offset the *Go left* or *Go right* field shows the same information as the *H.Offset* field.
- When the *Deltas* is set to Station and offset and the *Stake* method is set to Relative to azimuth, the *Go left* or *Go right* field is replaced by the *delta Elev (to last)* staked point field.

Editing the design elevation

- The design elevation appears in the bottom right corner of the navigation window. To edit the elevation, tap the arrow. To reload an edited elevation, select *Reload original elevation* from the pop-up menu in the *Design elevation* field. If the navigation window contains five rows of navigation information, the label for the *Design elevation* field is not shown.
- After staking, you can modify the design elevation in the as-staked deltas screen, depending on the [stake out style sheet](#) being used.

Stakeout - Lines

To stake out a line in a conventional survey:

1. Do one of the following:
 - ◆ From the map, select two points to define a line, tap and hold on the map and then select *Stake out line* from the menu.

- ◆ From the map, select the line to be staked out. Tap *Stakeout*, or tap and hold on the map and then select *Stake out line* from the menu.
- ◆ From the main menu, select *Stakeout / Lines*. Enter the line name.
- ◆ In the *Line name* field (or the *Start point or the End point* field) use the advanced pop-up arrow to select staking either a keyed-in line or one defined from two points.
- ◆ To stake out a line, double tap it on the map.
- ◆ When selecting a line to stakeout, tap near the end of the line that you want to designate as the start. Arrows are then drawn on the line to indicate the direction.
If the direction is incorrect, tap the line to deselect it and then tap it at the correct end to reselect the line in the direction required. Alternatively tap and hold on the map and select *Reverse line direction* from the menu.

Note - If the line has been offset, the offset directions are not swapped when the line direction is reversed.

2. In the *Stake* field, select one of the following options:

- ◆ *To the line*
- ◆ *Station on the line*
- ◆ *Station/offset from line*
- ◆ *Slope from line*

3. Enter the *Antenna/Target height*, the value of the station to be staked out (if any), and any further details, such as horizontal and vertical offsets. Tap *Start*.
4. Use the [graphical display](#) to navigate to the point.
5. When the point is within tolerance measure the point.

To the line

Use this option, as shown in the diagram below, to stake out points on a defined line starting with the closest point (1) from your current position (2).

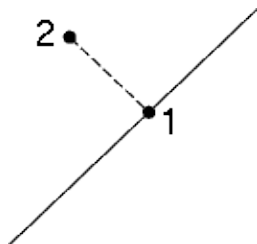

Station on the line

Use this option, as shown in the diagram below, to stake out stations (1) on a defined line at the station interval (2) along the line.



Station/offset from line

Use this option, as shown in the diagram below, to stake out points (1) perpendicular to stations (3) on a defined line (2) and offset to the left or right by a set distance (4).

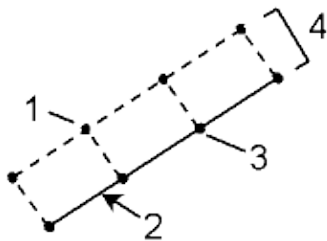

Slope from line

Use this option, as shown in the diagram below, to stake out points on surfaces (2), at different defined grades (3), either side of the defined line (1).

Use the *Slope left* field and the *Slope right* field to define the type of grade in one of the following ways:

- horizontal and vertical distance
- grade and slope distance
- grade and horizontal distance

At any point on the surface, the display shows the closest station, the Horizontal offset, and the Vertical distance as a cut (4) or a fill (5).

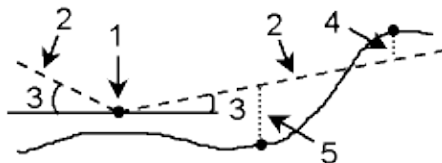

Mines - Auto Stakeout

Mines - Auto stake

The Auto Stakeout menu contains functions for auto staking the following features:

- [Center line](#)
- [Grade line](#)
- [Laser lines](#)
- [Laser lines offset from a center line](#)
- [Project line](#)
- [Blast holes](#)
- [Pivot points](#)

Tip - To blink the laser when storing a point measured with DR, select *Instrument / EDM settings* and then set the number of times the laser will blink in the *Blink laser* field.

Auto Stakeout from the map

You can select linework from a DXF file to define and then auto stake a *Center line*, *Grade line*, *Laser lines*, *Project line*, and *Blast holes*. You can also use points in a DXF file to define *Pivot points*. See the [Active map](#) for details on selecting features from the map.

To auto stakeout from the map:

1. Select *Jobs / Map*.
2. From the map, select the features that define the line(s), blast hole(s) or pivot point(s) to stake.
3. Tap *Auto Stakeout*. Alternatively, having selected the feature(s), exit the map and then select *Auto Stakeout* from the main menu.
4. Select the auto stake method.

Notes

- ◆ The method must be appropriate for the features selected to auto stake.
- ◆ When selecting a line to auto stakeout, tap near the end of the line that you want to designate as the start. Arrows are then drawn on the line to indicate the direction.
If the direction is incorrect, tap the line to deselect it and then tap it at the correct end to reselect the line in the direction required.
- ◆ If you select more than one line when staking a *Center line*, *Grade line*, and *Project line*, only the first selected line is available to auto stake.

5. Tap *Next*.
6. The selected entity(s) will be displayed for auto staking by the selected method.

Refer to the links above for further details on the various methods.

Auto stake Center line

Use Auto stake *Center line* to automatically mark out a line at set intervals along the mine backs (ceiling).

To auto stake a center line:

1. Tap *Auto Stakeout*, select a survey style and then start a survey.

From the Trimble Access menu tap *Settings / Survey styles* to edit an existing style or to define a new style.

2. Tap *Center line*.
3. Define the *Start point* by keying in the point name, or by using one of the options in the [advanced pop-up arrow](#).
4. Define the *End point* by keying in the point name, or by using one of the options in the [advanced pop-up arrow](#).

Tips

- ◆ Alternatively, you can use the [Active map](#) to select a line from a DXF file to define the center line.
 - ◆ Tap *Swap* to reverse the direction of the line. This option can be useful to ensure that the line direction is correct when the line has been selected from a DXF file.
5. Define an *Interval* for staking the line.

Tap the *Page down* button to view the line definition.

6. Define offsets if required. The center line can be offset by a:
 - ◆ *Horizontal offset* - applied left or right of the center line
 - ◆ *Vertical offset* - applied up or down from the center line
 - ◆ *Station offset* - applied backward or forward along the center lineThese offsets are used to calculate the design positions.

7. To extend the center line, enter the extension distance in the *Extend beyond end point* field. To shorten the center line, enter a negative value in this field.
8. Tap *Next* to go to the [Settings](#) screen.
9. Enter values for the *Point details*, *Position tolerance*, and *Settings* or accept the default values.
10. Tap *Next* to auto stake the line.

The instrument turns to the design point, measures a position and then checks this position against the defined tolerances. If it is outside the tolerances it turns to a new position and repeats the process until a position within tolerance is found, or the maximum number of iterations is reached.

The software will use the previous position to reduce the number of iterations required to find the next position. However if a position is not found within tolerance the software will use the design position of the previous position to reduce the number of iterations required to find the next position.

Tip - If the instrument points to the floor rather than the backs, during the *Start delay* period, you can manually point the instrument to the backs.

When a position is found within tolerance, the *Mark point* event sounds and the laser point flashes for the period defined in the *Mark delay* field in *Settings*.

If a point within tolerance cannot be found, the point is skipped.

Tip - Stakeout deltas indicate the direction you need to go to get to the target.

At the end of the *Mark delay* period the instrument auto stakes the next point.

11. Tap the *Pause* button to temporarily halt the auto stake process. Use the *Prev* and *Next* softkeys to skip to the previous or next point.

When the end of the line is reached, the *Results* screen shows the number of points staked and the number of points skipped.

Advanced pop-up arrow

The following methods of point definition are available from the advanced pop-up arrow:

List	Select from a list of all database points
Wildcard search	Filtered search of the database
Key in	Create a point in the database by keying in the <i>Point name</i> , <i>Code</i> , and <i>Coordinates</i> .
Fast fix	Quickly measure and automatically store a point. Wherever the instrument is pointing, that position is stored.
Measure	View the measure topo screen so that you can enter the <i>Point name</i> , <i>Code</i> , and <i>Target height</i> .
Map selections	View a list of points selected from the map

Auto stake Grade line

Use Auto stake *Grade line* to automatically mark out a line at set intervals along the mine walls.

To auto stake a grade line:

1. Tap *Auto Stakeout*, select a survey style and then start a survey.

From the Trimble Access menu tap *Settings / Survey styles* to edit an existing style or to define a new style.

2. Tap *Grade line*.
3. Define the *Start point* by keying in the point name, or by using one of the options in the [advanced pop-up arrow](#).

4. Define the *End point* by keying in the point name, or by using one of the options in the [advanced pop-up arrow](#).

Tips

- ◆ Alternatively, you can use the [Active map](#) to select a line from a DXF file to define the grade line.
 - ◆ Tap *Swap* to reverse the direction of the line. This option can be useful to ensure that the line direction is correct when the line has been selected from a DXF file.
5. Define an *Interval* for staking the line.

Tap the *Page down* button to view the line definition.

6. Define offsets if required. The grade line can be offset by a:
 - ◆ *Horizontal offset* - applied left or right of the grade line
 - ◆ *Vertical offset* - applied up or down from the grade line
 - ◆ *Station offset* - applied backward or forward along the grade lineThese offsets are used to calculate the design positions.

7. To extend the grade line, enter the extension distance in the *Extend beyond end point* field. To shorten the grade line, enter a negative value in this field.
8. Tap *Next* to go to the [Settings](#) screen.
9. Enter values for the *Point details*, *Position tolerance*, and *Settings* or accept the default values.
10. Tap *Next* to auto stake the line.

The instrument turns to the design point, measures a position and then checks this position against the defined tolerances. If it is outside the tolerances it turns to a new position and repeats the process until a position within tolerance is found, or the maximum number of iterations is reached.

The software will use the previous position to reduce the number of iterations required to find the next position. However if a position is not found within tolerance the software will use the design position of the previous position to reduce the number of iterations required to find the next position.

Tip - If the instrument fails to point in the correct direction, during the [Start delay](#) period, you can manually point the instrument in the correct direction.

When a position is found within tolerance, the *Mark point* event sounds and the laser point flashes for the period defined in the *Mark delay* field in [Settings](#).

If a point within tolerance cannot be found, the point is skipped.

Tip - Stakeout deltas indicate the direction you need to go to get to the target.

At the end of the *Mark delay* period the instrument auto stakes the next point.

11. Tap the *Pause* button to temporarily halt the auto stake process. Use the *Prev* and *Next* softkeys to skip to the previous or next point.

When the end of the line is reached, the *Results* screen shows the number of points staked and the number of points skipped.

Auto stake Laser lines

Use Auto stake laser line to stake the intersection points between the mine walls and a line defined by two points.

Matched pairs of points must be defined using their point names. A point must have a prefix or suffix to identify it as the left or the right hand end of the line. The remainder of the point name must be identical for a match pair to be found. For example, if the Left points prefix is L and the Right points prefix is R, then the following points would be identified as matched pairs: L1-R1, L15-R15, L101-R101, etc.

Tip - The points can be imported into the job, linked to the current job, or imported into another job and that job linked to the current job. Use the *Jobs / Import* option to import points.

To auto stake laser lines:

1. Tap *Auto Stakeout*, select a survey style and then start a survey.

From the Trimble Access menu tap *Settings / Survey styles* to edit an existing style or to define a new style.

2. Tap *Laser lines*.
3. Set the *Selection method* to either *Prefix* or *Suffix* so it matches the naming convention of the points in your job.
4. Enter the *Left points prefix/suffix* and the *Right points prefix/suffix*, and then tap *Next*.

Tips

- ◆ Alternatively, you can use the [Active map](#) to select a line(s) from a DXF file to define the laser lines.
 - ◆ Tap *Swap* to reverse the direction of the line. This option can be useful to ensure that the line direction is correct when the line has been selected from a DXF file.
5. All matching pairs in the job's database with the correct prefix/suffix are listed. Highlight and delete any lines that do not require staking.
 6. Tap *Next* to go to the [Settings](#) screen.
 7. Enter values for the *Point details* and *Settings*, or accept the default values and then tap *Next*.
 8. Tap *Next* to auto stake the lines.

The Mines software stakes all the points on the left, starting with the first line and finishing on the last. It then stakes all the points on the right side, starting with the last line and finishing on the first.

The instrument turns to the design point, measures a position and then checks this position against the defined tolerances. If it is outside the tolerances it turns to a new position and repeats the process until a position within tolerance is found, or the maximum number of iterations is reached.

Tip - If the instrument fails to point in the correct direction, during the *Start delay* period, you can manually point the instrument in the correct direction.

When a position is found within tolerance, the *Mark point* event sounds and the laser point flashes for the period defined in the *Mark delay* field in *Settings*.

If a point within tolerance cannot be found, the point is skipped.

Tip - Stakeout deltas indicate the direction you need to go to get to the target.

At the end of the *Mark delay* period the instrument auto stakes the next point.

10. Tap the *Pause* button to temporarily halt the auto stake process. Use the *Prev* and *Next* softkeys to skip to the previous or next point.

When the process has finished, the *Results* screen shows the number of points staked and the number of points skipped.

Auto stake Laser line from center line

Use Auto stake Laser line from CL to stake the intersection points between the laser line and the mine wall. The laser lines are defined at right angles relative to the center line at a defined interval.

To auto stake laser lines from a center line:

1. Tap *Auto Stakeout*, select a survey style and then start a survey.

From the Trimble Access menu tap *Settings / Survey styles* to edit an existing style or to define a new style.

2. Tap *Laser lines offset from CL*.
3. Define the *Start point* by keying in the point name, or by using one of the options in the [advanced pop-up arrow](#).
4. Define the *End point* by keying in the point name, or by using one of the options in the [advanced pop-up arrow](#).

Tips

- ◆ Alternatively, you can use the [Active map](#) to select a line(s) from a DXF file to define the laser lines.
- ◆ Tap *Swap* to reverse the direction of the line. This option can be useful to ensure that the line direction is correct when the line has been selected from a DXF file.

5. Define an *Interval* for staking the line.

Tap the *Page down* button to view the line definition.

6. Define offsets if required. The center line can be offset by a:
 - ◆ *Vertical offset* - applied up or down from the center line
 - ◆ *Station offset* - applied backward or forward along the center line

These offsets are used to calculate the design positions.

7. To extend the center line, enter the extension distance in the *Extend beyond end point* field. To shorten the center line, enter a negative value in this field.
8. Tap *Next* to review the defined laser lines. Highlight and delete any lines that do not require staking.
9. Tap *Next* to go to the *Settings* screen.
10. Enter values for the *Point details* and *Settings*, or accept the default values and then tap *Next*.
11. To aid in the auto stakeout of the laser lines you are prompted to aim and measure a position on the right side of the mine. Repeat when prompted for the left side.
12. Tap *Next* to auto stake the lines.

The Mines software stakes all the points on the left, starting with the first line and finishing on the last. It then stakes all the points on the right side, starting with the last line and finishing on the first.

The instrument turns to the design point, measures a position and then checks this position against the defined tolerances. If it is outside the tolerances it turns to a new position and repeats the process until a position within tolerance is found, or the maximum number of iterations is reached.

Tip - If the instrument fails to point in the correct direction, during the *Start delay* period, you can manually point the instrument in the correct direction.

When a position is found within tolerance, the *Mark point* event sounds and the laser point flashes for the period defined in the *Mark delay* field in *Settings*.

If a point within tolerance cannot be found, the point is skipped.

Tip - Stakeout deltas indicate the direction you need to go to get to the target.

At the end of the *Mark delay* period the instrument auto stakes the next point.

13. Tap the *Pause* button to temporarily halt the auto stake process. Use the *Prev* and *Next* softkeys to skip to the previous or next point.

When the process has finished, the *Results* screen shows the number of points staked and the number of points skipped.

Auto stake Project Line

Use Auto stake *Project line* to stake the intersection point between a mine face and a line.

The line can be defined by:

- Two points:

- ◆ Selected from the map
- ◆ Keyed in
- ◆ Measured
- A line selected from the map
- Two points or a line selected from a DXF file

Tip - The points can be imported into the job, linked to the current job, or imported into another job and that job linked to the current job. Use the *Jobs / Import* option to import points.

To project a line:

1. Tap *Auto Stakeout*, select a survey style and then start a survey.

From the Trimble Access menu tap *Settings / Survey styles* to edit an existing style or to define a new style.

2. Tap *Project line*.
3. Define the *Start point* by keying in the point name, or by using one of the options in the [advanced pop-up arrow](#).
4. Define the *End point* by keying in the point name, or by using one of the options in the [advanced pop-up arrow](#).

Tips

- ◆ Alternatively, you can use the [Active map](#) to select two points or a line from a DXF file to define the line.
 - ◆ Tap *Swap* to reverse the direction of the line. This option can be useful to ensure that the line direction is correct when the line has been selected from a DXF file.
 - ◆ Tap the *Page down* button to view the line definition.
5. Define offsets if required. The grade line can be offset by a:
 - ◆ *Horizontal offset* - applied left or right of the grade line
 - ◆ *Vertical offset* - applied up or down from the grade line
 6. Tap *Next* to go to the [Settings](#) screen.
 7. Enter values for the *Point details*, *Position tolerance*, and *Settings* or accept the default values.
 8. Tap *Next* to auto stake the line.

The instrument turns to the design point, measures a position and then checks this position against the defined tolerances. If it is outside the tolerances it turns to a new position and repeats the process until a position within tolerance is found, or the maximum number of iterations is reached.

Tip - If the instrument fails to point in the correct direction, during the [Start delay](#) period, you can manually point the instrument in the correct direction.

When a position is found within tolerance, the *Mark point* event sounds and the laser point flashes for the period defined in the *Mark delay* field in [Settings](#).

If a point within tolerance cannot be found, the point is skipped.

Tip - Stakeout deltas indicate the direction you need to go to get to the target.

9. Tap the *Pause* button to temporarily halt the auto stake process.

When the end of the line is reached, the *Results* screen shows the number of points staked and the number of points skipped.

Auto stake Blast holes

Use Auto stake blast holes to stake the intersection point between a mine face and a line defined by two points.

Matched pairs of points must be defined using their point names. A point must have a prefix or suffix to identify it as the blast hole collar or toe. The remainder of the point name must be identical for a match pair to be found. For example, if the collar points suffix is C and the toe points suffix is T, then the following points would be identified as matched pairs: 1C-1T, 15C-15T, A1C-A1T, etc.

Tip - The points can be imported into the job, linked to the current job, or imported into another job and that job linked to the current job. Use the *Jobs / Import* option to import points.

To auto stake blast holes:

1. Tap *Auto Stakeout*, select a survey style and then start a survey.

From the Trimble Access menu tap *Settings / Survey styles* to edit an existing style or to define a new style.

2. Tap *Blast holes*.
3. Set the *Selection method* to either *Prefix* or *Suffix* so it matches the naming convention of the points in your job.
4. Enter the *Collar points prefix/suffix* and the *Toe points prefix/suffix* and then tap *Next*.

Tips

- ◆ Alternatively, you can use the [Active map](#) to select a line(s) from a DXF file to define the blast holes.
 - ◆ Tap *Swap* to reverse the direction of the line. This option can be useful to ensure that the line direction is correct when the line has been selected from a DXF file.
5. All matching pairs in the job's database with the correct prefix/suffix are listed. Highlight and delete any lines that do not require staking.
 6. Tap *Next* to go to the [Settings](#) screen.
 7. Enter values for the *Point details* and *Settings*, or accept the default values and then tap *Next*.
 8. Tap *Next* to auto stake the blast holes.

The instrument turns to the design point, measures a position and then checks this position against the defined tolerances. If it is outside the tolerances it turns to a new position and repeats the process until

a position within tolerance is found, or the maximum number of iterations is reached.

Tip - If the instrument fails to point in the correct direction, during the *Start delay* period, you can manually point the instrument in the correct direction.

When a position is found within tolerance, the *Mark point* event sounds and the laser point flashes for the period defined in the *Mark delay* field in *Settings*.

If a point within tolerance cannot be found, the point is skipped.

Tip - Stakeout deltas indicate the direction you need to go to get to the target.

At the end of the *Mark delay* period the instrument auto stakes the next point.

10. Tap the *Pause* button to temporarily halt the auto stake process. Use the *Prev* and *Next* softkeys to skip to the previous or next point.

When the process has finished, the *Results* screen shows the number of points staked and the number of points skipped.

Auto stake Pivot points

Use Auto stake Pivot points to stake out pivot points that have been projected up onto the mine back.

Pivot points must be identified by either a prefix or suffix in their point name.

Tip - The points can be imported into the job, linked to the current job, or imported into another job and that job linked to the current job. Use the *Jobs / Import* option to import points.

To auto stake pivot points:

1. Tap *Auto Stakeout*, select a survey style and then start a survey.

From the Trimble Access menu tap *Settings / Survey styles* to edit an existing style or to define a new style.

2. Tap *Pivot points*.
3. Set the *Selection method* to either *Prefix* or *Suffix* so it matches the naming convention of the points in your job.
4. Enter the *Pivot points prefix/suffix* and then tap *Next*.

Tip - Alternatively, you can use the *Active map* to select points from a DXF file to define the pivot points.

5. All points in the job's database with the correct prefix/suffix are listed. Highlight and delete any lines that do not require staking.
6. Tap *Next* to go to the *Settings* screen.

7. Enter values for the *Point details* and *Settings*, or accept the default values and then tap *Next*.
8. When prompted, aim the instrument at the mine back and then tap *Measure*. This ensures that the auto staked points will be located on the back.

The instrument turns to the design point, measures a position and then checks this position against the defined tolerances. If it is outside the tolerances it turns to a new position and repeats the process until a position within tolerance is found, or the maximum number of iterations is reached.

When a position is found within tolerance, the *Mark point* event sounds and the laser point flashes for the period defined in the *Mark delay* field in *Settings*.

If a point within tolerance cannot be found, the point is skipped.

Tip - Stakeout deltas indicate the direction you need to go to get to the target.

At the end of the *Mark delay* period the instrument auto stakes the next point.

10. Tap the *Pause* button to temporarily halt the auto stake process. Use the *Prev* and *Next* softkeys to skip to the previous or next point.

When the process has finished, the *Results* screen shows the number of points staked and the number of points skipped.

Settings

Use the *Point details* group to specify the *Start point* and *Point code*.

Use the *Position tolerance* group to specify the *Station* and *Offset* tolerances for a *Center line* and the *Station* and *Grade* tolerances for a *Grade line*. The *Station* tolerance value applies forward and back along the line. The *Offset* tolerance is defined left and right of the line. The *Grade* tolerance is defined up and down from the line and perpendicular to the line.

Use the *Settings* group to specify the *EDM timeout*, *Mark delay*, *Start delay*, the number of *Iterations*, and whether or not the staked points are to be stored.

The *Mark delay* is the length of time, in seconds, that the laser point flashes once the position is found.

The *Start delay* gives you time to walk to the location of the first point to be marked.

If the number of iterations is exceeded, or the EDM times out, the point is skipped.

Tip - You can reduce the EDM timeout to improve performance. If the instrument struggles to get a measurement due to, for example, reflective or dark surfaces, increase the EDM timeout.

Reports

Generating a report

Use the *Report* option to create custom ASCII files on the controller while in the field. Use the predefined formats or create your own custom formats. With custom formats, you can create files of almost any description. Use these files to check data in the field, or to produce reports, which you can transfer from the field to your client or to the office for further processing with the office software.

You can modify a predefined format to meet your specific requirements, or use it as a template to create a completely new custom ASCII export format.

To create a report of survey data:

1. Open the job that contains the data to export.
2. From the Mines menu, tap *Report*.
3. In the *File format* field, specify the type of file to create.
4. Tap  to select an existing folder or create a new one.
5. Enter a filename.

By default, the *File name* field shows the name of the current job. The filename extension is defined in the XSLT style sheet. Change the file name and extension as required.

6. If more fields are displayed, complete them.

You can use the XSLT style sheets to generate files and reports based on parameters that you define. For example, when generating a Stakeout report, the *Stakeout horizontal tolerance* and the *Stakeout vertical tolerance* fields define acceptable stakeout tolerances. When generating the report you can stipulate the tolerances, then any stakeout delta greater than the defined tolerances appears in color in the generated report.

Note - When the selected XSLT style sheet is applied to create the custom export file, the processing is all carried out in the program memory available on the device. If there is not enough memory to enable the creation of the export file, an error message will be displayed and no export file will be created.

Four factors will affect whether the export file can be created

1. The amount of program memory available to the device.
2. The size of the job being exported.
3. The complexity of the style sheet being used to create the export file.
4. The amount of data being written to the export file.

If it is not possible to create the export file on the controller, download the job as a JobXML file to a computer.

To create the export file from the downloaded JobXML file using the same XSLT style sheet, use the ASCII File Generator utility program (available from www.trimble.com).