

HELP

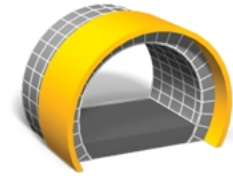

Trimble Access™ Tunnels



Version 2017.22
Revision A
February 2019

Legal information

Trimble Inc.

www.trimble.com

Copyright and Trademarks

© 2009–2019, Trimble Inc. All rights reserved.

For full copyright and trademark information, refer to the *Trimble Access Help*.

Contents

- 1 Introduction Tunnels 5**
 - Introduction 5
 - Interacting with other applications 6
- 2 Define Tunnels 7**
 - Define 7
 - Horizontal alignment 10
 - Entry by length / coordinates 10
 - Entry by end station 13
 - Entry by PI 15
 - Transitions 17
 - Vertical alignment 18
 - Entry by vertical points of intersection (VPI) 19
 - Entry by start and end points 20
 - Templates 21
 - Template positions 23
 - Example alignment 25
 - Rotation 26
 - Set out positions 27
 - Station equations 29
 - Alignment offsets 29
 - Import 30
- 3 Survey Tunnels 32**
 - Survey 32
 - Auto scanning positions 34
 - Manually measuring positions 38
 - Position in tunnel 40
 - Setting out positions 41
 - Scan settings and tolerances 45
 - Current position information 48
 - Machine positioning 49
 - On station adjustment 51
 - Set out position tolerance 52
 - Measuring a position with a prism 52
- 4 Review Tunnels 54**
 - Review 54

5 Reports58
 Generating a report 58

Introduction Tunnels

Introduction

Use the Trimble® Tunnels software to:

- Define your tunnel
 - Define tunnel components including horizontal and vertical alignments, templates, and rotation, or import a definition from a LandXML file.
 - Define end-face blast holes and set-out positions typically used for bolt holes.
 - Review the tunnel before going underground.
- Survey your tunnel
 - Auto scan cross sections including options to manually measure and delete points.
 - Measure positions relative to the tunnel definition.
 - Set out pre-defined positions.
 - Position machinery, typically a drilling rig, relative to the tunnel.
- Output and reports
 - Review auto scanned and manually measured points.
 - Review set out points.

Tunnels software menus

From the Trimble Access menu tap Tunnels to:

- Manage your [jobs](#)
- [Define](#) your tunnel
- [Survey](#) your tunnel
- [Review](#) your surveyed tunnel
- Report your surveyed tunnel

Managing jobs

From Tunnels tap *Jobs* to manage jobs, review job properties and data, view the map and import and export files.

For more information, see [Managing jobs](#).

Note – When defining, surveying, positioning, reviewing and reporting your tunnel the tunnel file must be in the same folder as the current job.

Further information

The contents of this file are installed on the controller with your application.

For information that extends or updates this Help, refer to the *Trimble Access Release Notes*. Go to <http://apps.trimbleaccess.com/help> to download the latest PDF file of the *Trimble Access Release Notes* or help file for each Trimble Access application.

Tip – For links between the Trimble Access application help PDF files to work, download PDF files to the same folder on your computer and do not change any of the file names.

Interacting with other applications

You can run more than one application at a time and easily switch between them. For example, you can switch between functions in *Roads*, *Tunnels*, *Mines*, and *General Survey*.

To run more than one application at a time, use the Trimble button or Trimble icon in the top left corner of the screen to open the Trimble Access menu. From there, you can run the other application.

To switch between applications:

- Tap the Trimble button in the task bar to access the menu of available applications and services currently running, including the Trimble Access menu. Select the application or service to switch to.
- On the TSC3 controller, a short press of the Trimble button accesses the menu of available applications and services currently running, including the Trimble Access menu. Select the application or service to switch to.
- On the Geo7X/GeoXR controller, tap the Trimble button to access the menu of available applications and services currently running, including the Trimble Access menu and the *Windows Start Menu*.
- On the Trimble Slate controller, tap the Trimble button to access the menu of available applications and services currently running, including the Trimble Access menu.
- Tap *Switch to* and then select the required function from the list. If the *Switch to* button is not on your current screen, press **CTRL W** to open the *Switch to* pop-up list.
- Press **CTRL TAB**. This is the keyboard shortcut to scroll through the current list of *Switch to* functions.
- Tap *Favourites* or press **CTRL A** to select a preconfigured favorite.
- On a controller that has application/function keys, configure the appropriate key for the function you want to run. This method opens an application even if that application is not running.

For more information, see *General Survey* buttons.

Define Tunnels

Define

Use the *Define* option to:

- Define a tunnel by entered components, or edit a tunnel
- Define a tunnel from selected entities in the map
- Review a tunnel

To define and survey the tunnel using the term 'chainage' rather than 'station' for the distance along the tunnel, from the main Trimble Access screen select *Settings / Language* and then select the *Use chainage distance terminology* check box.

Defining or editing a tunnel

1. Tap *Define*.
2. Tap *New* and then enter a name for the tunnel definition.

(To edit or review an existing tunnel, highlight the tunnel name and then tap *Edit*.)

Tip - Use the *Copy* option to copy an existing tunnel definition with all its components into the current tunnel.

3. Choose a component to key in:

Horizontal alignment

Vertical alignment

Templates

Template positions

Rotation

Set out positions

Station equations

Alignment offsets

Defining a tunnel from the map

You can also define a tunnel from the map by selecting points, lines, or arcs or by selecting line work contained in DXF, STR, SHP, or LandXML files. To do this:

1. Tap *Define*.
2. From the *Select a file* screen tap *Map* to display the map.
3. Tap the entities that you wish to use to define the horizontal alignment of the tunnel. If the entities have elevations these will be used to define the vertical alignment of the tunnel.

Tips

- The order in which points are selected and the direction of the lines and arcs is very important as this defines the tunnel direction.
 - If selecting line work contained in DXF, STR, SHP, or LandXML files, tap the *Layers* softkey, select the file and then make active the appropriate layer(s) that will be used to define the horizontal alignment.
4. From the tap and hold menu, tap *Store tunnel*.
 5. In the popup screen enter a tunnel name, start station, and station interval.
 6. Tap *OK*.

The defined tunnel can now be edited from the *Define* menu, where you can add other components such as templates and set out positions.

Tip - You may have to re-enter the *Define* menu to select the new tunnel.

See also Active map.

Tips

- Tap and hold on the alignment, offset alignment, design points (shown as solid blue circles), set out points, and the vertex point (shown as a short green line) to browse its horizontal and vertical offsets, northing, easting, elevation, surface name, and code.
- Use *Rename* and *Delete* to rename or delete a tunnel definition.

Notes

- *The Tunnels software treats all tunnel distances, including station and offset values, as grid distances. The value in the Distances field (accessed from the Trimble Access menu by selecting Settings / Units Cogo / Cogo Settings) has no effect on the tunnel definition or the way tunnel distances are displayed.*
- *If a ground coordinate system is defined in the job, the grid coordinates are, in effect, also ground coordinates.*
- *Keyed in tunnels are saved to the current project folder as 'tunnel name'.txt. Tunnels are available for all jobs in the current project folder.*
- *To use a file saved to the current project folder in another project, use Windows Explorer to copy or move the file to the appropriate project folder.*

Reviewing a tunnel

1. Tap the *Review* softkey to see a plan view of the tunnel.

The horizontal alignment is shown as a black line and the offset alignment (where applicable) is shown as a green line.

2. By default the first station is selected.

The selected station appears as a red circle.

To select another station to review use one of the following methods:

- Tap and hold on the screen and then select a station from the list in the *Select stations* field.
- Tap an individual station.
- Press an up or down arrow on the controller keyboard.

Tips

- To add a unique station, tap and hold on the screen and then select *Add station*.
 - Tap *Calc* from the second row of softkeys to calculate the grid and tunnel coordinates. Use this option to confirm the definition before surveying the tunnel.
 - Tap and hold on a position to browse its station, northing, easting and elevation.
 - Tap and hold on the pan softkey to make it active and then use the left, right, up, or down arrow keys on the controller to pan around the screen.
3. To view the cross section for the selected station, tap the icon at the bottom right of the screen or press the **Tab** key.
 - A red cross indicates the design alignment.
 - If the alignment is offset, a small green cross indicates the offset alignment.
 - If the tunnel has been rotated and the pivot position for the rotation is offset from the alignment, a green circular icon indicates the pivot position.
 - A short green line at the top of the profile indicates the vertex point.

See the following diagram:

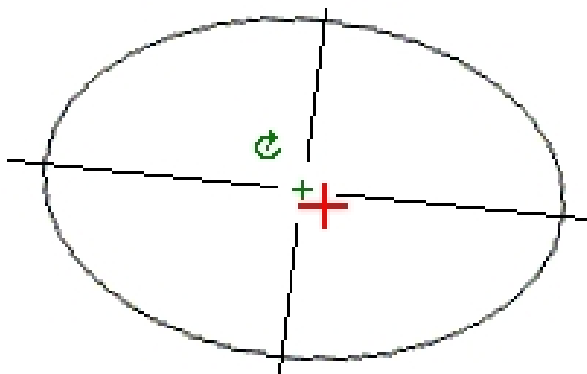

The station value of the selected station, its rotation value where applicable, and the alignment offset values where applicable, appear at the top of the screen.

Tips

- Tap and hold on a position to see its horizontal and vertical offsets, northing, easting, and elevation.
- If the design alignment has been offset, the reported offset values are to the offset alignment. If rotation has been applied and the pivot position has been offset, the reported offsets are to the offset position.

To select another station to review use one of the following methods:

- Tap and hold on the screen and then select a station from the list in the *Select stations* field.
- Press an up or down arrow on the controller keyboard.

Horizontal alignment

To add a horizontal alignment to a tunnel definition, select *Horizontal alignment*. You can enter the alignment using one of the following methods:

[Length / coordinates](#)

[End station](#)

[PI](#)

You can also define the horizontal alignment (and vertical alignment if the line work has elevations) from features (points, lines, and arcs) in a file. To do this:

1. From the map, tap the *Layers* softkey, select the file and then make active the appropriate layer(s) that will be used to define the horizontal alignment.
2. Select the feature. See *Using the map for common tasks* for further details.
3. From the tap and hold menu, select *Store tunnel*.
4. Enter a name, start station, and station interval.
5. Tap *OK*.

From the *Define* menu, you can view the horizontal (and vertical alignment if applicable) for the resultant tunnel. You can enter other tunnel components if required.

Entry by length / coordinates

To add a horizontal alignment to a tunnel definition by entering the lengths of the elements or the end coordinates, select *Horizontal alignment* and then do the following:

1. Tap *New* to enter the first element that defines the alignment. The *Element* field is set to *Start point*. You cannot change this.
2. Enter the *Start station*.
3. In the *Method* field, choose one of the following options:
 - *Key in coordinates*
 - *Select point*

If you choose the *Key in coordinates* method, enter values in the *Start north* and *Start east* fields.

If you choose the *Select point* method field, enter a value in the *Point name* field. The *Start north* and *Start east* fields will update with the values for the entered point.

Tip - To edit the *Start north* and *Start east* values when they have been derived from a point, change the method to *Key in coordinates*.

4. Enter the *Station interval*. To add the horizontal element, tap *Store*. The start point appears in the graphical view.
5. Tap *Options* to select the *Transition type*.
Note - For more information on supported transition types, see [Transitions](#).
6. To enter the next horizontal element, tap *New*. In the *Entry Method* field, select *Length/Coordinates* and then tap *OK*.
7. Select the *Element* method, enter the required information, and then tap *Store*. The element appears in the graphical view.

Tips

- Tap the up arrow to access the *map softkeys* to navigate around the graphical view.
 - Tap and hold on the pan softkey to make it active and then use the left, right, up, or down arrow keys on the controller to pan around the screen.
8. To enter further elements, see the following:
 - [Line elements](#)
 - [Arc elements](#)
 - [Entry transition/exit transition elements](#)
 9. When you have entered the last element, tap *Accept*.

Notes

- When you add an element, it appears after the previous element that you added. To insert it at a particular place, highlight the element in the graphical view that you want it to follow. Tap *New* and enter details of the element.
 - Use the *Start*, *Prev*, *Next* and *End* softkeys to view other elements.
 - To edit an element, highlight it in the graphical view and tap *Edit*.
 - To delete an element, highlight it in the graphical view and tap *Delete*.
10. Enter the other tunnel components, or tap *Store* to store the tunnel definition.

Line elements

If you select *Line* in the *Element* field, the *Start station* field displays the start station value for the line that you are defining. You cannot edit this.

The following table shows the available methods and the fields that appear when you select each one.

Method	Procedure
Azimuth and length	In the <i>Azimuth</i> and <i>Length</i> fields, enter values that define the line. The <i>End north</i> and <i>End east</i> fields update with the values entered.
End coordinates	In the <i>End north</i> and <i>End east</i> fields, enter values that define the line. The <i>Azimuth</i> and <i>Length</i> fields update with the values entered.
Select end point	In the <i>Point name</i> field, enter a value. The <i>Azimuth</i> , <i>Length</i> , <i>End north</i> , and <i>End east</i> fields update with the values entered.

Tip - If this line is not the first line to be defined, the *Azimuth* field displays an azimuth calculated from the previous element. To edit the azimuth, select *Edit azimuth* from the pop-up menu in the *Azimuth* field. If the element is non tangential a solid red circle is shown at the start of the element.

Arc elements

If you select *Arc* in the *Element* field, the *Start station* field displays the start station value for the arc that you are defining. You cannot edit this.

The following table shows the available methods and the fields that appear when you select each one.

Method	Procedure
Radius and length	Specify arc direction. In the <i>Radius</i> and <i>Length</i> fields, enter values that define the arc.
Delta angle and radius	Specify arc direction. In the <i>Angle</i> and <i>Radius</i> fields, enter values that define the arc.
Deflection angle and length	Specify arc direction. In the <i>Angle</i> and <i>Length</i> fields, enter values that define the arc.
End coordinates	In the <i>End north</i> and <i>End east</i> fields, enter values that define the arc. The <i>Arc direction</i> , <i>Radius</i> , and <i>Length</i> fields update with the values entered.
Select end point	In the <i>Point name</i> field, enter a value that defines the arc. The <i>Arc direction</i> , <i>Radius</i> , <i>Length</i> , <i>End north</i> , and <i>End east</i> fields update with the values entered.
End coordinates and center point	In the <i>End north</i> , <i>End east</i> , <i>Center point north</i> , and <i>Center point east</i> fields, enter values that define the arc. If required select <i>Large arc</i> . The <i>Azimuth</i> , <i>Arc direction</i> , <i>Radius</i> , and <i>Length</i> fields update with the values entered.
Select end and center points	In the <i>End point name</i> and <i>Center point name</i> fields, enter values that define the arc. If required select <i>Large arc</i> . The <i>Azimuth</i> , <i>Arc direction</i> , <i>Radius</i> , <i>Length</i> , <i>End north</i> and <i>End east</i> fields update with the values entered.

Tip - For an arc defined by *Radius and length*, *Delta angle and radius* or *Deflection angle and length*, the *Azimuth* field shows the azimuth as calculated from the previous element. If the element

is non tangential a solid red circle is shown at the start of the element. To reload the original azimuth, select *Restore tangency* from the pop-up menu.

Entry transition/exit transition elements

If you select *Entry transition/Exit transition* in the *Element* field, the *Start station* field displays the start station value for the entry transition or exit transition that you are defining. You cannot edit this.

Specify the arc direction. In the *Start radius*, *End radius* and *Length* fields, enter values that define the transition.

The *End North* and *End East* fields update to display the coordinates at the end of the element just added.

Note - For more information on supported transition types, see [Transitions](#).

Tips

- The *Azimuth* field displays the azimuth as calculated from the previous element. To edit the azimuth, select *Edit azimuth* from the pop-up menu in the *Azimuth* field. If the element is non tangential a solid red circle is shown at the start of the element.
- If the transition type is NSW cubic parabola the computed *Transistion Xc* value is displayed. If the transition is between two arcs the *Transistion Xc* displayed is the value computed for the common tangent point with the smaller of the two arcs.

Entry by end station

To add a horizontal alignment to a tunnel definition by entering end station values, select *Horizontal alignment* and then do the following:

1. Tap *New* to enter the first element that defines the alignment. The *Element* field is set to *Start point*. You cannot change this.
2. Enter the *Start station*.
3. In the *Method* field, choose one of the following options:
 - *Key in coordinates*
 - *Select point*

If you choose the *Key in coordinates* method, enter values in the *Start north* and *Start east* fields.

If you choose the *Select point* method field, enter a value in the *Point name* field. The *Start north* and *Start east* fields will update with the values for the entered point.

Tip - To edit the *Start north* and *Start east* values when they have been derived from a point, change the method to *Key in coordinates*.

4. Enter the *Station interval*. To add the horizontal element, tap *Store*. The start point appears in the graphical view.
5. To enter the next horizontal element, tap *New*. In the *Entry Method* field select *End station* and then tap *Ok*.
6. Select the *Element* method, enter the required information, and then tap *Store*. The element

appears in the graphical view.

Tips

- Tap the up arrow to access the *map softkeys* to navigate around the graphical view.
 - Tap and hold on the pan softkey to make it active and then use the left, right, up, or down arrow keys on the controller to pan around the screen.
7. To enter further elements, see the following:

[Line elements](#)

[Arc elements](#)

[Entry transition/exit transition elements](#)

8. When you have entered the last element, tap *Accept*.

Notes

- *When you add an element, it appears after the previous element that you added. To insert it at a particular place, highlight the element in the graphical view that you want it to follow. Tap New and enter details of the element.*
 - *Use the Start,Prev,Next and End softkeys to view other elements.*
 - *To edit an element, highlight it in the graphical view and tap Edit.*
 - *To delete an element, highlight it in the graphical view and tap Delete.*
9. Enter the other tunnel components, or tap *Store* to store the tunnel definition.

Tip - Tap *Method* to change the entry method to *Length*.

Line elements

If you select *Line* in the *Element* field, the *Start station* field displays the start station value for the line that you are defining. You cannot edit this.

In the *Azimuth* and *End station* fields, enter values that define the line. The *End North* and *End East* fields update to display the coordinates at the end of the element just added.

Tip - If this line is not the first line to be defined, the *Azimuth* field displays an azimuth calculated from the previous element. To edit the azimuth, select *Edit azimuth* from the pop-up menu in the *Azimuth* field. A solid red circle is shown at the start of an element if adjoining elements are non tangential.

Arc elements

If you select *Arc* in the *Element* field, the *Start station* field displays the start station value for the arc that you are defining. You cannot edit this.

The following table shows the available methods and the fields that appear when you select each one.

Method	Procedure
Radius and end station	Specify arc direction. In the <i>Radius</i> and <i>End station</i> fields, enter values that define the arc.
Deflection angle and end	Specify arc direction. In the <i>Angle</i> and <i>End station</i> fields, enter values

station that define the arc.

The *End North* and *End East* fields update to display the coordinates at the end of the element just added.

Tip - The *Azimuth* field displays the azimuth as calculated from the previous element. To edit the azimuth, select *Edit azimuth* from the pop-up menu in the *Azimuth* field. A solid red circle is shown at the start of an element if adjoining elements are non tangential or if adjoining elements defining a curve have different radii.

Entry transition/exit transition elements

If you select *Entry transition/Exit transition* in the *Element* field, the *Start station* field displays the start station value for the entry transition or exit transition that you are defining. You cannot edit this.

Specify arc direction. In the *Start radius*, *End radius* and *End station* fields, enter values that define the transition.

The *End North* and *End East* fields update to display the coordinates at the end of the element just added.

Note - For more information on supported transition types, see [Transitions](#).

Tips

- The *Azimuth* field displays the azimuth as calculated from the previous element. To edit the azimuth, select *Edit azimuth* from the pop-up menu in the *Azimuth* field. A solid red circle is shown at the start of an element if adjoining elements are non tangential or if adjoining elements defining a curve have different radii.
- If the transition type is NSW cubic parabola the computed *Transistion Xc* value is displayed. If the transition is between two arcs the *Transistion Xc* displayed is the value computed for the common tangent point with the smaller of the two arcs.

Entry by PI

To add a horizontal alignment to a tunnel road definition by entering the points of intersection (PI), select *Horizontal alignment* and then do the following:

1. Tap *New* to enter the first element that defines the alignment. The *Element* field is set to *Start point*. You cannot change this.
2. Enter the *Start station*.
3. In the *Method* field, choose one of the following options:
 - *Key in coordinates*
 - *Select point*

If you choose the *Key in coordinates* method, enter values in the *Start north* and *Start east* fields.

If you choose the *Select point* method field, enter a value in the *Point name* field. The *Start north* and *Start east* fields will update with the values for the entered point.

Tip - The selected entry method will be the default for subsequent elements. To change the entry method, select the *Method* option.

Tip - To edit the *Start north* and *Start east* values when they have been derived from a point, change the method to *Key in coordinates*.

4. Enter the *Station interval*. To add the horizontal element, tap *Store*.
5. To enter the next horizontal element tap *New*. In the *Entry method* field, select *PI* and then tap *OK*.

6. Tap *Options* to select the *Transition type*.

Note - For more information on supported transition types, see [Transitions](#).

7. Tap *New* and select the *Curve type*, enter the required information, and then tap *Store*. For details on supported curve types, see the following:

None

Circular

Transition | Arc | Transition

Transition | Transition

8. When you have entered the last element, tap *Accept*.

Tip - To delete an element, highlight it and tap *Delete*. When you add an element, it appears below the previous element that you added. To insert it at a particular place in the list, highlight the element that you want it to follow. Tap *New* and enter details of the element.

9. Enter the other road components or tap *Store* to store the road definition.

Curve type: None

Define the PI and then select *None* in the *Curve type* field.

Curve type: Circular

Define the PI and then select *Circular* in the *Curve type* field. Enter values defining the *Radius* and *Arc length* and then tap *Store*.

Curve type: Transition | Arc | Transition

Define the PI and then select *Transition | Arc | Transition* in the *Curve type* field. Enter values defining the *Radius*, *Arc length*, *Transition length in*, and *Transition length out* and then tap *Store*.

Note - For more information on supported transition types, see [Transitions](#).

Curve type: Transition | Transition

Define the PI and then select *Transition | Transition* in the *Curve type* field. Enter values defining the *Radius*, *Transition length in*, and *Transition length out* and then tap *Store*.

Note - For more information on supported transition types, see [Transitions](#).

Transitions

The Tunnels software supports the following transition types.

Method	Length	End station	PI
Clothoid spiral	*	*	*
Egg-shaped clothoid spiral	*	*	-
Cubic spiral	*	*	*
Bloss spiral	*	*	*
Korean cubic parabola	*	*	*
NSW cubic parabola	*	*	-

Clothoid spiral

The clothoid spiral is defined by the length of the spiral and the radius of the adjoining arc. The formulae for the x and y parameters in terms of these two values are as follows:

Parameter x :

$$x = l \left[1 - \frac{l^4}{40R^2L^2} + \frac{l^8}{3456R^4L^4} - \dots \right]$$

Parameter y :

$$y = \frac{l^3}{6RL} \left[1 - \frac{l^4}{56R^2L^2} + \frac{l^8}{7040R^4L^4} - \dots \right]$$

Egg-shaped clothoid spiral

By editing the *Start / End radius* for an *Entry / Exit transition* from *Infinite* to a required radius it is possible to define an egg shaped clothoid. To return to an infinite radius, select *Infinite* from the pop-up menu.

Cubic spiral

The cubic spiral is defined by the length of the spiral and the radius of the adjoining arc. The formulae for the x and y parameters in terms of these two values are as follows:

Parameter x :

$$x = l \left[1 - \frac{l^4}{40R^2L^2} + \frac{l^8}{3456R^4L^4} - \dots \right]$$

Parameter y :

$$y = \frac{l^3}{6RL}$$

Bloss spiral

Parameter x :

$$x = l \left[1 - \frac{l^6}{14R^2L^4} + \frac{l^7}{16R^2L^5} - \frac{l^8}{72R^2L^6} + \frac{l^{12}}{312R^4L^8} - \frac{l^{13}}{168R^4L^9} + \frac{l^{14}}{240R^4L^{10}} - \frac{l^{15}}{768R^4L^{11}} + \frac{l^{16}}{6528R^4L^{12}} \right]$$

Parameter y :

$$y = \left[\frac{l^4}{4RL^2} - \frac{l^5}{10RL^3} - \frac{l^{10}}{60R^3L^6} + \frac{l^{11}}{44R^3L^7} - \frac{l^{12}}{96R^3L^8} - \frac{l^{13}}{624R^3L^9} \right]$$

Note - The Bloss spiral can only be fully developed, that is, for an entry transition the start radius is infinite and similarly for an exit transition the end radius is infinite.

Korean cubic parabola

This cubic parabola is defined by the length of the parabola and the radius of the adjoining arc. The formulae for the x and y parameters in terms of these two values are as follows:

Parameter x :

$$x = l \left[1 - \frac{l^4}{40R^2L^2} \right]$$

This formula is the same as for the x parameter of the clothoid spiral, reduced to the first term of the series.

Parameter y :

$$y = \frac{x^3}{6RX}$$

Note - The Korean cubic parabola can only be fully developed, that is, for an entry transition the start radius is infinite and similarly for an exit transition the end radius is infinite.

NSW cubic parabola

The NSW cubic parabola is a special parabola used for rail projects in New South Wales, Australia. It is defined by the length of the parabola and an m value. Refer to

http://engineering.railcorp.nsw.gov.au/Civil_EngineeringStandards.asp and see *Track Geometry Stability*, Reference number: *ESC 210* for the formulae for the x and y parameters in terms of these two values.

Vertical alignment

To add a vertical alignment to a tunnel definition, select *Vertical alignment*. You can enter the alignment using one of the following methods:

[Vertical points of intersection](#)

[Start and end points](#)

Note - The selected entry method applies to all elements defining the vertical alignment.

Tip - If you defined the horizontal alignment for your tunnel from line work in a file, and the line work has elevations, these will be used to define the vertical alignment as a series of *Point* elements. See [Horizontal alignment](#) for further details. The vertical alignment can be edited if required.

Entry by vertical points of intersection (VPI)

To add a vertical alignment to a tunnel definition by entering Vertical Points of Intersection (VPI), select *Vertical alignment* and then do the following:

1. To enter the first element that defines the alignment, tap *New*.
2. In the *Station* and *Elevation* fields, key in the values that define the first vertical point of intersection. The *Element* field is set to *Start point*. You cannot change this.
3. Tap *Store* to add the vertical element record.
4. Tap *New*. In the entry method field select *VPI* and then tap *Ok*.
5. Select the *Element* method, enter the required information, and then tap *Store*.
6. To enter further elements, see the following:

[Point elements](#)

[Circular arc elements](#)

[Symmetric parabola elements](#)

[Asymmetric parabola elements](#)

7. When you have entered the last element, tap *Accept*.

Notes

- When you add an element, it appears after the previous element that you added. To insert it at a particular place, highlight the element in the list that you want it to follow. Tap *New* and enter details of the element.
- Use the *Start*, *Prev*, *Next* and *End* softkeys to view other elements.
- To edit an element, highlight it in the list and tap *Edit*.
- To delete an element, highlight it in the list and tap *Delete*.

8. Enter the other tunnel components, or tap *Store* to store the tunnel definition.

Point elements

If you select *Point* in the *Element* field, use the *Station* and *Elevation* fields to key in values that define the VPI. The *Slope in* field updates to display the calculated slope value. The *Slope out* field updates when the next element is added.

Note - A vertical alignment defined by VPIs must end with a point.

Circular arc elements

If you select *Circular arc* in the *Element* field, use the *Station* and *Elevation* fields to key in values that define the VPI. Enter the radius of the circular arc in the *Radius* field. The *Slope in*

field updates to display the calculated slope value. The *Length, K factor* and *Slope out* fields update when the next element is added.

Symmetric parabola elements

If you select *Sym parabola* in the *Element* field, use the *Station* and *Elevation* fields to key in values that define the VPI and a length for the parabola. The *Slope in* field updates to display the calculated slope value. The *K factor* and *Slope out* fields update when the next element is added.

Asymmetric parabola elements

If you select *Asymmetric parabola* in the *Element* field, use the *Station* and *Elevation* fields to key in values that define the VPI. Enter the In and Out lengths of the parabola. The *Slope in* field updates to display the calculated slope value. The *K factor* and *Slope out* fields update when the next element is added.

Note - When you edit an element, only the selected element is updated. All adjoining elements remain unchanged.

Tip - To confirm the entry, use the *Slope in*, *Slope out*, and *K factor* values.

Entry by start and end points

To add a vertical alignment to a tunnel definition by entering Start and end points, select *Vertical alignment* and then do the following:

1. To enter the first element that defines the alignment, tap *New*.
2. In the *Station* and *Elevation* fields, key in the values that define the first vertical point of intersection. The *Element* field is set to *Start point*. You cannot change this.
3. Tap *Store* to add the vertical element record.
4. Tap *New*. In the entry method field select *Start and End points* and then tap *Ok*.
5. Select the *Element*, enter the required information and then tap *Store*. For details on supported elements, see the following:

[Point elements](#)

[Circular arc elements](#)

[Symmetric parabola elements](#)

6. When you have entered the last element, tap *Accept*.

Notes

- When you add an element, it appears after the previous element that you added. To insert it at a particular place, highlight the element in the list that you want it to follow. Tap *New* and enter details of the element.
 - Use the *Start, Prev, Next* and *End* softkeys to view other elements.
 - To edit an element, highlight it in the list and tap *Edit*.
 - To delete an element, highlight it in the list and tap *Delete*.
7. Enter the other tunnel components, or tap *Store* to store the tunnel definition.

Point elements

If you select *Point* in the *Element* field, use the *Station* and *Elevation* fields to key in values that define the start point. The *Slope in* field updates to display the calculated slope value. The *Slope out* field updates when the next element is added.

Circular arc elements

If you select *Circular arc* in the *Element* field, use the *Start station*, *Start elevation*, *End station*, *End elevation*, and *Radius* fields to key in values that define the circular arc. The *Length*, *Slope in*, and *Slope out* fields update to display the calculated values.

Symmetric parabola elements

If you select *Sym parabola* in the *Element* field, use the *Start station*, *Start elevation*, *End station*, *End elevation*, and *K factor* fields to key in values that define the parabola. The *Length*, *Slope in*, and *Slope out* fields update to display the calculated values.

Note - When you edit an element, only the selected element is updated. All adjoining elements remain unchanged.

Tip - To confirm the entry, use the *Slope in*, *Slope out*, and *Length* values.

Templates

A template defines the profile of the tunnel and may consist of any number of surfaces. A surface can be defined by any of the following:

- Entering line and arc elements
- Measuring positions within a tunnel
- Copying and then offsetting an existing surface

To define a template for a tunnel definition, select *Templates* and then do the following:

1. Tap *New*, enter a template name and then tap *Add*.

Tips

- To edit an existing template, highlight the template name and tap *Edit*. Highlight the surface to edit and tap *Edit*. Then, from the graphical template view select the element and then tap *Edit*.
- Use the *Copy from* option to copy an existing template definition, either from the current tunnel or from a previously defined tunnel, into the current template.
- To create a template library, define a tunnel that only contains templates.

2. From the *Select a surface* screen tap *New*, enter a surface name and then tap *Add*.

Tip - Use the *Copy from* option to copy an existing surface by a specified offset.

3. Tap *New* to enter the start point element defining the surface.

Tip - Use the *Measure* softkey to measure positions within a tunnel to define elements in a surface. If no surface elements have been defined, tap *Measure* to define the *Start point*. If the surface consists of one or more elements, tap *Measure* to define the end point of a line element. To use this option, you must start a survey.

4. In the *Horizontal offset* and *Vertical offset* fields, enter the values that define the *Start point*

and then tap *Store*. The element appears in the graphical view.

Tap the up arrow to access the *map softkeys* to navigate around the graphical view.

5. To enter further elements, tap *New*, select the *Element* and *Method* and then enter the required information. For details on supported elements and entry methods, see the following:

[Line elements](#)

[Arc elements](#)

6. When you have entered the last element, tap *Accept*.

Notes

- *Templates must be defined in a clockwise direction.*
- *When you add an element, it appears after the previous element that you added. To insert it at a particular place, highlight the element in the graphical view that you want it to follow. Tap *New* and enter details of the element.*
- *Use the *Start*, *Prev*, *Next* and *End* softkeys to view other elements.*
- *To edit an element, highlight it in the graphical view and tap *Edit*.*
- *To delete an element, highlight it in the graphical view and tap *Delete*.*
- *Surfaces can be open or closed.*

7. To save the surface, tap *Accept*.

Tip - To rename a surface, highlight it and then tap *Rename*. To delete a surface, highlight it and then tap *Delete*.

8. To save the template, tap *Accept*.

Tip - To rename a template, highlight it and then tap *Rename*. To delete a template, highlight it and then tap *Delete*.

9. Enter the other tunnel components, or tap *Store* to store the tunnel definition.

Line elements

To add a line to the template definition, select *Line* in the *Element* field.

The following table shows the available methods and the fields that appear when you select each one.

Method	Procedure
Cross slope and offset	In the <i>Cross slope</i> and <i>Offset</i> fields, enter values that define the line. To change the way a cross slope value is expressed, tap <i>Options</i> and then change the <i>Grade</i> field as required.
Delta elevation and offset	In the <i>Delta elevation</i> and <i>Offset</i> fields, enter values that define the line.
End point	In the <i>Horizontal offset</i> and <i>Vertical offset</i> fields, enter values that define the end point of the line.

Arc elements

To add an arc to the template definition, select *Arc* in the *Element* field.

The following table shows the available methods and the fields that appear when you select each one.

Method	Procedure
End point and Radius	In the <i>Horizontal offset</i> and <i>Vertical offset</i> fields, enter values that define the end point of the arc. Enter the <i>Radius</i> . Select <i>Large arc</i> , if required.
Alignment and Delta angle	Specify the <i>Delta angle</i> for the arc. The center point for the arc is defined by the horizontal and vertical alignments.
Center point and delta angle	In the <i>Horizontal offset</i> and <i>Vertical offset</i> fields, enter values that define the center point of the arc. Enter the <i>Delta angle</i> for the arc.

Tip - On page two the parameters defining the arc are displayed.

Template positions

To define the position of templates in a tunnel definition, specify the station at which the Tunnels software starts to apply each template. For station values between applied templates, the template element values are interpolated.

Two interpolation methods are supported:

[Norwegian interpolation](#)

[Linear interpolation](#)

Note - The templates applied must have the same number of elements.

Norwegian interpolation method

This method maintains the radii of the first and last arcs (referred to as wall arcs), as well as the radii of the second and fourth 'transition' arcs when present, and computes a new radius for the central (or roof) arc. It uses interpolation of the arc angles rather than the radii values.

This method is automatically used if the templates applied at the previous and next stations fulfill the following requirements:

- Each template consists of 3 or 5 arcs in sequence joined tangentially
- There is no 'tilt' to the defined section (template)

If the above requirements are not met the [Linear interpolation](#) method is used.

Linear interpolation

For this method, the template element values are interpolated linearly (applied on a pro rata basis), from a template applied at the previous station to the station where the next template is applied.

This method is used if the requirements for the *Norwegian method* are not met.

Defining the template positioning

1. Select *Template positioning*.
2. Tap *New*.
3. In the *Start station* field, specify the start station for the template(s).
4. Select the templates to apply. The options in the drop-down list for the *Template* field are:
 - <None> - no template is assigned. Use this option to create a gap in the tunnel definition.
 - Templates - defined using the *Define / Templates* option.
5. The surfaces making up the selected template are displayed. Select the surface you want to use.
6. Tap *Store* to apply the template.
7. Tap *New* to enter more templates at other positions.
8. When all template positions are entered tap *Accept*.

Notes

- Use the *Start*, *Prev*, *Next* and *End* softkeys to view other template positions.
 - To edit a template position, highlight it in the list and tap *Edit*.
 - To delete a template position, highlight it in the list and tap *Delete*.
9. Enter the other tunnel components, or tap *Store* to store the tunnel definition.

For more information, see the [example alignment](#) with the associated table. That topic describes how to use the template assignments, including the <None> template, and the *Surface to use* option to achieve the required tunnel definition.

Note - Tap the *Options* softkey to specify if the templates are applied *Vertical* or *Perpendicular* to the vertical alignment. See the following diagram where the red line work indicates the template applied perpendicular and the blue line work a template applied vertically.

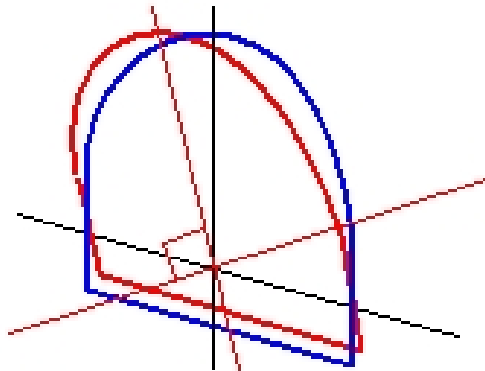

The station and offset display of points relative to a tunnel using *Point manager* or *Review job* are only calculated vertical to the alignment. If the templates were applied perpendicular in Tunnel positioning then the station and offsets will be different.

Example alignment

The following discussion explains how the template assignments, including the <None> template, and the *Surfaces to use* option can be used to control a tunnel definition. See the plan in the following figure where the tunnel is a consistent width from station 0 to 20, has a gap between stations 20 and 40, widens from station 60 to 80 and then is a constant width to station 140.

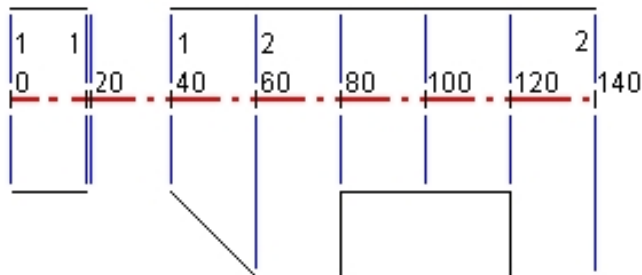

See also the two templates in the following figure where template 1 (on the left side in the figure) has two surfaces and template 2 has three surfaces:

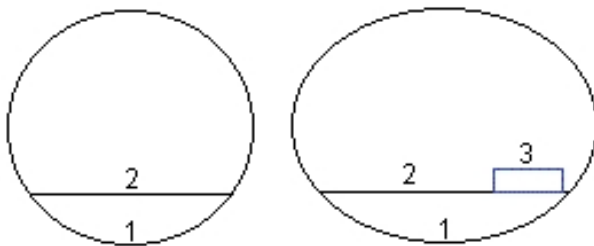

To define this design you need to assign the templates with the appropriate surfaces selected as shown in the following table:

Start station	Templates	Surface 1	Surface 2	Surface 3
0.000	Template 1	On	On	-
20.000	Template 1	On	On	-
20.005	<None>	-	-	-
40.000	Template 1	On	On	-
60.000	Template 2	On	On	Off
80.000	Template 2	On	On	On
120.000	Template 2	On	On	Off

Start station	Templates	Surface 1	Surface 2	Surface 3
140.00	Template 2	On	On	Off

Rotation

Use rotation to tilt or rotate a tunnel template and associated setout positions around an origin point. Rotation is mainly used around a horizontal curve to represent superelevation. However, it can be used anywhere in the tunnel alignment provided that there is a valid horizontal alignment, vertical alignment, and template assigned.

To define rotation:

1. From the *Define* tunnel menu, select *Rotation*.
2. Tap *New*.
3. Enter the *Start station* for the rotation.
4. Enter the *Rotation* value.

If the tunnel is to rotate to the left, enter a negative value.

If the tunnel is to rotate to the right, enter a positive value.

If you are defining the start of the rotation, enter a rotation value of 0%.

5. (Optional). Enter the *Horizontal offset* and *Vertical offset* of the *Pivot position*.
If the rotation pivots around the alignment, leave the offsets as 0.000.

Notes

- If the horizontal and/or vertical alignment has been offset, the *Horizontal offset* and the *Vertical offset* of the *Pivot position* are relative to the offset alignment.
- If the pivot position has been offset from the alignment, an icon  indicating the offset position is displayed in the cross section view when:
 - reviewing a tunnel definition
 - surveying a tunnel
 - reviewing a surveyed tunnel

6. Tap *Store* to apply the rotation.
7. Tap *New* to enter a new rotation value at another station.
8. To edit an existing rotation value, highlight the record and then tap *Edit*.
9. To delete an existing rotation value, highlight the record and then tap *Delete*.
10. When all rotation values are entered, tap *Accept*.
11. Enter the other tunnel components, or tap *Store* to store the tunnel definition.

Note - The following describes the order that templates of different shapes, with rotation applied, are computed before interpolation of intermediate stations takes place:

1. Construct the first template and apply rotation
2. Construct the second template and apply rotation
3. Interpolate between the two resolved templates

Set out positions

Set out positions typically define bolt holes within a tunnel. They are defined by station and offset values and a method.

You can define set out positions using one of the following methods:

- [Keyed in values](#)
- [Imported from a file](#)

Note – Trimble recommends that you define the tunnel template before you key in or import setout positions. If you define setout positions before defining the tunnel template they will be assigned the first surface defined in the template when the tunnel is stored.

Keying in setout position values

1. Select *Set out positions*.
2. Tap *New*.
3. In the *Start station* field, specify the start station for the position to be set out.
4. In the *End station* field, specify the end station for the position to be set out.
Tip - Leave the *End station* field blank if the set out position is to apply to all stations.
5. Select the *Method* to define the set out position.

The following diagram and table describes each method.

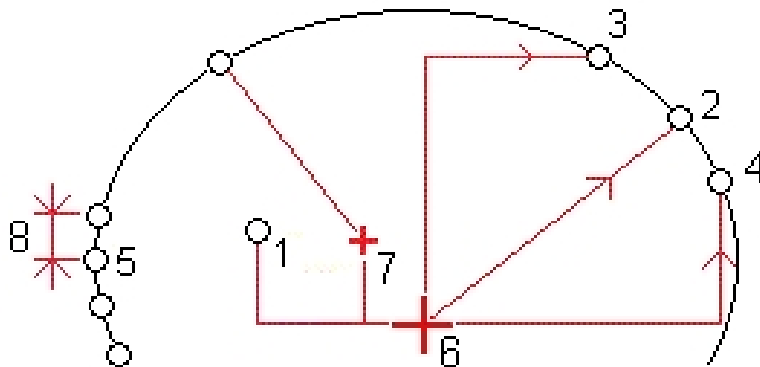

1	Blast hole	5	Multiple radial
2	Radial	6	Alignment
3	Horizontal	7	Offset center
4	Vertical	8	Interval

The following table shows the available methods and the fields that appear when you select each one.

Method	Procedure
Blasthole	In the <i>Start station</i> and <i>End station</i> fields and the <i>Horizontal offset</i> and <i>Vertical offset</i> fields, enter values that define the position to be set out.
Radial	In the <i>Start station</i> and <i>End station</i> fields and the <i>Horizontal offset</i> and <i>Vertical offset</i> fields, enter values that define the position to be set out.
Horizontal	In the <i>Start station</i> and <i>End station</i> fields and the <i>Vertical offset</i> field, enter values that define the position to be set out. Select the horizontal <i>Direction</i> the offset is applied.
Vertical	In the <i>Start station</i> and <i>End station</i> fields and the <i>Horizontal offset</i> field, enter values that define the position to be set out. Select the vertical <i>Direction</i> the offset is applied.
Multiple radial	In the <i>Start station</i> and <i>End station</i> fields and the <i>Interval</i> field, enter values that define the position to be set out.

Tip - For each method, the horizontal and vertical offsets are relative to the alignment. But if the alignment has been offset, the offsets are relative to the offset alignment.

For the radial method, to define a new center offset from the alignment, enter *Horizontal offset* and *Vertical offset* values in the *Radial center offsets* group box.

For the radial, horizontal, vertical, and multiple radial methods, select the surface that the set out position is relative to.

For all methods, you can specify a *Code*.

Tip - The annotation entered in the *Code* field is assigned to the end of the position and is displayed when setting out the position.

6. Tap *Store* to apply the set out position.
7. Tap *New* to enter more set out positions.

Tips

- To copy a highlighted entry, tap *Copy*.
 - To delete a highlighted entry, tap *Delete*.
8. When all set out positions are entered, tap *Accept*.
 9. Enter the other tunnel components, or tap *Store* to store the tunnel definition.

Importing set out positions

You can import set out positions from a comma-separated file. To do this, from the second row of softkeys, tap *Import*. The file format is:

Start station, End station, Method, Hz offset, Vt offset, Code, Direction, Surface name, Center hz offset, Center vt offset

See the following examples for the format for each set out method:

Set out positions	Method	Example formats
End face blast holes	Blasthole	40,60,Blasthole,0.5,-0.5,Blast hole
Radial bolt holes	Radial	0,40,Radial,-3.2,2.2,Bolt hole,,S2,1.05,0.275
Horizontal bolt holes	Horizontal	0,20,Horizontal,,3.1,Bolt hole,Right,S2
Vertical bolt holes	Vertical	0,,Vertical,3.2,,Bolt hole,Up,S2

Notes

- The *Surface name*, *Code*, *Center hz offset*, and *Center vt offset* values are optional.
- If no *Surface name* is specified, or the *Surface name* is not applicable for the specified station range, the first template surface suitable for the station range is used.
- The *Method* value is expected to be one of the following: *Blasthole*, *Horizontal*, *Vertical*, *Radial*.
- The *Direction* value is expected to be one of the following: *Up*, *Down*, *Left*, *Right*, or empty (for a radial offset or blast hole).
- You cannot import Multiple radial set out points.

Station equations

Use *Station equations* to define the station values for an alignment.

To define an equation:

1. Select *Station equations*.
2. Tap *New*.
3. In the *Back station* field, enter a station value.
4. In the *Ahead station* field, enter a station value. The *True station* value will be calculated.
5. Tap *Store*.

The values entered in the *Back station* and *Ahead station* fields are shown: The zone is indicated by a number after the colon in each field. The calculated *Progression*, indicating whether the station value increases or decreases after the station equation, is also shown.

Note - The zone up to the first station equation is zone 1.

Tip - To change the progression for the last station equation, tap *Edit*.

6. To add further equations, tap *New*. To delete an equation, tap *Delete*. To accept the entered equations, tap *Accept*.

Alignment offsets

Use alignment offsets to offset the horizontal and / or vertical alignment. Alignment offsets are typically used at horizontal curves in a rail tunnel to ensure that carriage clearance is maintained

when the track is superelevated. However, they can be used anywhere along the tunnel alignment provided there is a valid horizontal alignment, vertical alignment, and template assigned.

The following diagram illustrates using alignment offsets to avoid carriage conflict with the design tunnel.

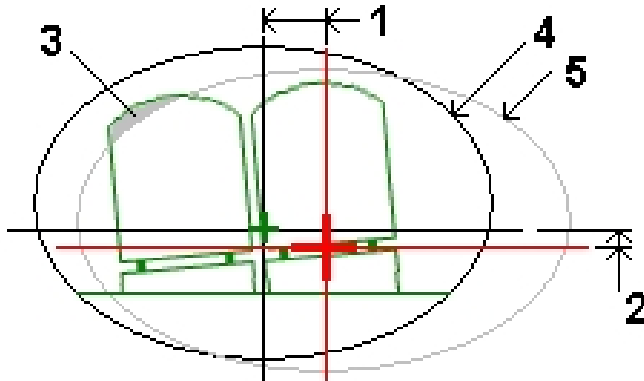

- | | | | |
|---|-------------------|---|---------------|
| 1 | Horizontal offset | 4 | Offset tunnel |
| 2 | Vertical offset | 5 | Design tunnel |
| 3 | Carriage conflict | | |

Defining alignment offsets

1. From the *Define* tunnel menu, select *Alignment offsets*.
2. Tap *New*.
3. Enter the *Start station* for the offsets.
4. Enter the *Horizontal offset* and / or *Vertical offset*.
5. Tap *Store* to apply the offsets.
6. Tap *New* to enter offsets at another station.
7. To edit an existing offset, highlight the record and then tap *Edit*.
8. To delete an existing offset, highlight the record and then tap *Delete*.
9. When all offsets are entered, tap *Accept*.
10. Enter the other tunnel components, or tap *Store* to store the tunnel definition.

Note - If the alignment has been offset and a rotation has been applied to the templates, the rotation is applied first and then the alignment is offset.

Import

You can convert a LandXML file that defines a tunnel to a Trimble txl file for use in the Tunnels software. The LandXML file is converted using the [ASCII File Generator] utility program available on www.trimble.com.

Before you can convert a LandXML file, you must copy the [LandXML To TunnelXML.xsl] file from www.trimble.com to the [Custom ASCII Files] folder on your office computer.

Converting a LandXML file to a txl file

1. On the office computer, select [Start / Programs / Trimble Data Transfer / ASCII File Generator] to start the [ASCII File Generator] utility program.
2. From the *Source JobXML or Job file* field, select *Browse*. Set the *File of type* field to *All files*. Browse to the appropriate folder and then select the LandXML file to convert.
3. From the *Output format* field, select the [LandXML To TunnelXML] style sheet.
4. Select *OK*.
5. From the *User Value Input* screen, select the tunnel surface to be converted.
6. Select *OK*.
7. Confirm the *Save in* folder and *File name* for the txl file and then select *Save*.
8. When done, select *Close*.

Use the Windows Mobile Device Center to copy the txl file to the controller.

Tip - To create txl files for other surfaces in the LandXML file, repeat steps 1 through 8.

Survey Tunnels

Survey

Use Survey to:

- [Auto scan cross sections](#)
- [Manual measure positions](#)
- [Measure positions relative to a tunnel](#)
- [Set out positions](#)
- Measure surface - select this option to access the [Define](#) option. This enables you to define template surface elements from positions measured in a tunnel.

To define and survey the tunnel using the term 'chainage' rather than 'station' for the distance along the tunnel, from the main Trimble Access screen select *Settings / Language* and then select the *Use chainage distance terminology* check box.

Supported instruments

Conventional instruments that can be connected to the controller running Trimble Access Tunnels are:

- Trimble SX10 scanning total station
- Trimble VX Spatial Station
- Trimble S Series total stations: S5/S7/S9 and S3/S6/S8
- Trimble mechanical total stations: C5, M3
- Spectra Precision® total stations: FOCUS® 35/30
- Some third-party total stations

When starting a survey you will be asked to select the survey style you have configured for your equipment. To learn more about survey styles and related connection settings refer to the *General Survey Help*.

Laser pointer

If you are using a total station equipped with a laser pointer, the laser indicates the location of the current position or the selected setout position on the tunnel surface.

To blink the laser when storing a point measured with DR, select *Instrument / EDM settings* and then set the number of times the laser will blink in the *Blink laser* field.

Notes

- The Tunnels software defaults to tracking mode when scanning and measuring in a tunnel. If you select standard mode, you achieve better quality but slower measuring times.
- Using an instrument that is not equipped with a laser pointer requires a different workflow when setting out positions. For more information, see [Setting out positions](#).

3R Laser Pointer

If you are using a Trimble S8 or S9 total station equipped with the high-power laser pointer, before storing a point, tap *3R Laser* to enable the high-power laser pointer and show the mark on the tunnel surface. An icon appears at the bottom right of the screen to show that the laser is active. Tap *Measure* to measure the position and then tap *Store* to record the current position in the job's database.









Notes











- Even though the high-power laser pointer is not coaxial with the telescope, the instrument can automatically turn to measure to the laser pointer location. When you tap *3R Laser*, a preliminary measurement is taken to determine the vertical angle to turn the instrument so that the distance is measured to where the high-power laser pointer is pointing. When you tap *Measure*, the instrument automatically turns to that location and takes the measurement. The instrument then turns so that the high-power laser again points to the measured position. The preliminary measurement is not stored.
- The calculation of the vertical angle to turn to assumes the horizontal distance to the preliminary measurement is similar to the distance to the high-power laser pointer location. To measure to the high-power laser point when it is near the upper or lower edge of an object, consider using face 1 to take measurements at the lower edge of an object, and face 2 to take measurements at the upper edge of an object so that the preliminary measurement does not overshoot the object you are measuring to.

WARNING - The high power laser is a class 3R laser that emits laser radiation - do not stare into the beam or view directly with optical instruments.

Icons

The icons that appear when surveying a tunnel are shown below.

Plan view icon	Description	Cross section view icon	Description
	Station available for selection		Scanned position within tolerance
	Station unavailable for selection		Scanned position outside of tolerance
	Selected station (Auto scan)		Stored set out position
	Scanned station within tolerance		Set out position

Plan view icon	Description	Cross section view icon	Description
	Scanned station with positions outside of tolerance		Selected set out position
	Current station		Alignment axis
	High-power laser pointer active		High-power laser pointer active
			Offset alignment axis / Rotated alignment axis
			Current position
			The tunnel profile is displayed in the direction of increasing station.
			The tunnel profile is displayed in the direction of decreasing station.

Auto scanning positions

Auto scan measures points at a defined scan interval for selected stations. The resulting positions are compared to the design template surface for that station.

Note - Use *Manual measure* to scan a tunnel using a mechanical total station.

Auto scanning positions in a tunnel

1. Tap *Survey*, select a survey style and start a survey.
From the Trimble Access menu tap *Settings / Survey styles* to edit an existing style or to define a new style.
2. Tap *Autoscan*.
3. Select a tunnel from the list.
Tip - To add files from another folder to the list, tap *Add*, navigate to the required folder and then select the file(s) to add.
4. To define the scan station range, use one of the following methods to select stations to scan:
 - Key values into the *Start station* and *End station* fields.
 - In the *Start station* and *End station* fields, select *List* from the pop-up menu and then select values from the list.

- Highlight the *Start station* field, point the instrument to the required start point of the scan and then tap *Measure*. Repeat the process for the *End station*.
Tip - To survey in the direction of decreasing station, enter a *Start station* value that is greater than the *End station* value.
5. In the *Station interval* field, enter the required station interval for the scan. From the pop-up menu in *Station interval*, make sure that the correct interval method is selected. The options are *0 based* and *Relative*.
 - The 0 based method is the default method and gives station values that are multiples of the station interval. For example, if the start station is 2.50 and the station interval is 1.00, the 0 based method produces stations at 2.50, 3.00, 4.00, 5.00, and so on.
 - The Relative method gives station values relative to the start station. For example, if the start station is 2.50 and the station interval is 1.00, the Relative method produces stations at 2.50, 3.50, 4.50, 5.50, and so on.
 6. Select the template surface to scan.
 7. Tap *Next* to view the selected station range in the plan view. The plan view automatically zooms to the defined range.

Tips

- Tap and hold on a position on the alignment (or offset alignment, if it is available) to browse its station, northing, easting, and elevation.
- Tap *Calc* from the second row of softkeys to calculate the grid and tunnel coordinates. Use this option to confirm the definition before surveying the tunnel.
- To add a station that is not defined by the station interval, tap and hold on the screen and then select *Add station* from the menu.

The graphical display shows	As
Horizontal alignment	Black line
Offset alignment (where applicable)	Green line
Current station	Red circle
Selected stations	Solid blue circle
Instrument position	Solid black circle
Direction instrument is pointing	Dashed red line

Tap a station to deselect it. Alternatively, tap and hold on the screen and then select *Clear selection* to clear all stations. The tap and hold menu also features a *Station list* from which you can select or deselect stations within the station range.

Note - Stations shown grayed out have no vertical alignment or no template assigned and cannot be selected for scanning.

Tip - As an alternative to defining a scan from the plan view, you can view a station to scan from the cross section view, tap and hold on the screen and then select *Scan current station*.

8. Tap *Next* to view the cross section of the first selected station. The selected template surface is highlighted.

Tip - To view a popup window showing information including (where applicable), horizontal and vertical offsets, northing, easting, elevation, surface name, and code information for an item, tap any of the following:

Item	Shown as
Alignment	Red cross
Offset alignment	Smaller green cross
Pivot position	Circular green icon
Design points	Blue circles
Vertex point	Short green line

9. If there are areas of the tunnel that cannot be scanned or need to be excluded from the scan, or if you want to scan only part of the tunnel profile, you can define scan zones to do this. Tap and briefly hold on the screen and then select *Add scan zone* from the pop-up menu.
10. Tap *Start* and then configure the scan *Settings*.
11. Tap *Accept* to configure the scan *Tolerances*.
12. Tap *Accept*. The Tunnels software begins scanning the first station.

For each scanned point, the point name overbreak / underbreak and delta station values are displayed. Each scanned position appears as a green circle (if within tolerance) or a red circle (if not within tolerance).

During scanning, tap *Pause* to pause the scan; tap *Continue* to resume scanning; and tap *Stop* to end the scan before it is completed. While paused, you can select any scanned position to view the deltas. If you are using a Trimble VX Spatial Station **and** the *VX scanning* check box is enabled in the *Settings* screen, tap *Stop* to stop the scan. Tap *Start* and Tunnels continues scanning the remaining points.

Once all points for the current station are scanned, the Tunnels software automatically advances to the next station until all selected stations are scanned.

Tip - When in the cross section view, tap the up arrow (next station) or tap the down arrow (previous station), to review other stations while still scanning. The station being scanned is indicated in the top left of the screen. The station being viewed is indicated at the top center of the screen.

13. Once all points for all selected stations are scanned, results show which stations have errors. You can expand stations with errors to see the number of points scanned, the number skipped, and the number of points outside tolerance. You can expand this last record to see the number of overbreak, underbreak, and delta station points.

Tip - The plan view shows the scanned stations. Stations with no errors appear as solid green circles, while those with errors appear as solid red circles.

14. Tap *Close* to finish.

Tip - After a scan is completed, you can do the following:

- To review a summary for each station, return to the plan view, tap and hold on the screen and then select *Results*.

- To see details for the current station, return to the cross section view, tap and hold on the screen and then select *Details*. See also [Review tunnel](#).
- To edit the tolerance values from either the plan or cross section view, tap and hold on the screen and then select *Tolerances*. The *Station*, *Overbreak*, and *Underbreak* deltas are updated to reflect the new tolerance values.

Notes

- *Auto scan defaults to tracking mode for each scan but will work in standard mode.*
- *When a scan starts, the DR target height and prism constant are automatically set to 0.00.*
- *When scanning with On station adjustment selected and using a*
 - *Trimble S Series total station or Trimble SX10 scanning total station, each point is scanned until it is found within tolerance.*
 - *Trimble VX Spatial Station, fifty points will be scanned at a time. The scan is repeated for those points that were not within tolerance.*
- *If the number of iterations is exceeded or the EDM times out, the point is skipped. The EDM timeout value can be configured in the [Settings](#) screen.*

Tip - During a conventional survey, you can use the tap and hold menu in the map to quickly measure a check point. If there are no points selected, *Check backsight* is available; if one point is selected *Check shot* is available. Alternatively, to measure a check shot from any screen, press [CTRL + K] on the controller.

Scan zones

Use scan zones when parts of the tunnel profile either do not require measuring or cannot be measured (for example, areas behind ventilation ducts).

Only points within the scan zone will be measured.

You can have multiple scan zones on the same profile.

Scan zones are applied to the entire length of the defined station range.

Defining scan zones

1. Follow steps 1 through 7 of performing an auto scan.
2. Tap and hold briefly on the screen, or press the space key and then select *Add scan zone*.
3. Point the instrument to where you want the scan zone to start. The instrument ray appears as a solid red line on screen. Tap *Accept* or press *Enter* to store the scan zone start point.

Note - *Scan zones must be defined in a clockwise direction.*

Tip - If you define the start of the scan zone in the wrong place, tap *Back* or press *Escape* to go back and redefine it.

4. Point the instrument to where you want the scan zone to end. The instrument ray appears as a solid red line on screen and the scan zone start appears as a red dashed line. Tap *Accept* or press *Enter* to store the scan zone end point.

The auto scan profile view appears. Points outside the scan zone are grayed out and will not be measured.

5. To define another scan zone, select *Add scan zone* again from the tap and hold menu.

To delete the scan zones, tap and hold briefly on the screen, or press the space key and then select *Delete scan zones*. All scan zones are deleted.

Manually measuring positions

Use manual measurement to:

- [Measure](#) a position that could not be measured by a scan.
- Manually [measure](#) a position with a mechanical instrument.
- [Delete](#) a scanned or manually measured position.

Performing a manual measurement

1. Follow the procedure for performing an [Auto scan](#).

The plan view displays the horizontal alignment of the tunnel, the instrument position, and the current direction. A black open circle indicates each station as defined by the station interval.

Tips

- Tap and hold on a position on the alignment (or offset alignment, if available) to browse its station, northing, easting, and elevation.
 - Tap *Calc* from the second row of softkeys to calculate the grid and tunnel coordinates. Use this option to confirm the definition before surveying the tunnel.
 - Tap the pan softkey and then use the left, right, up, and down arrow keys on the controller keyboard to pan around the screen.
2. If you are using a:
 - Servo or robotic instrument, tap and hold briefly on the screen, or press the Space key and then select *Manual measure* from the pop-up menu.
 - Mechanical instrument, you are automatically in *Manual measure* mode.

The selected mode, *Manual*, is shown at the top left of the screen.

From the tap and hold menu you can configure the [Settings](#) and [Tolerances](#).

Tip - If you can't measure to the tunnel surface with DR, then you can [measure to a prism](#) that is offset perpendicular to the design surface, where the target height is applied perpendicular to the tunnel profile. To do this, select the *Apply target height perpendicular to profile* option from [Settings](#). In the case where the prism is held against the tunnel surface you would enter the prism radius as the target height.

3. Select a station to measure using one of the following methods:
 - Tap an up or down arrow on the controller keyboard.
 - Tap an individual station.
 - Tap and hold on the screen and then select a station from the list in the *Select stations* field.

The selected station appears as a red circle.

4. Tap *Next* to view the cross section and measure.

Tip - Tap and hold on the alignment, offset alignment, design points (shown as blue circles), and the vertex point (shown as a short green line) to browse its horizontal and vertical offsets, northing, easting, elevation, surface name, and code.

5. If you are using a:

- Servo or robotic instrument, tap the location that you want to measure. The instrument automatically turns to that position. Alternatively, manually aim the instrument at the position you want to measure. When a measurement is received, the *Station*, *Underbreak*, *Overbreak* and *Delta station* values are shown. Tap *Store* to store the position.
- Mechanical instrument, aim the instrument at the position you want to measure and then tap *Measure*. The *Station*, *Underbreak*, *Overbreak* and *Delta station* values are shown. Tap *Store* to store the position.

Tips

- You can select a position to measure that has been defined by the *Scan interval*.
- If the instrument struggles to get a measurement due to, for example, reflective or dark surfaces, increase the value in the *EDM timeout* field in the *Settings* screen.
- If, when measuring without a prism, your current position (displayed as a cross) fails to update, then ensure the *Apply target height perpendicular to profile* option from *Settings* is not selected.

Note - If the *Start point name* has not been defined, the *Settings* screen appears. Complete the required fields and then tap *Accept*.

If the tolerances have not been defined, the *Tolerances* screen appears. Complete the required fields and then tap *Accept*.

Stations with no errors appear as solid green circles, while those with errors appear as solid red circles.

Tip - During a conventional survey, you can use the tap and hold menu in the map to quickly measure a check point. If there are no points selected, *Check backsight* is available; if one point is selected *Check shot* is available. Alternatively, to measure a check shot from any screen, press [CTRL + K] on the controller.

Deleting a measured position

1. From the cross section view, tap a point to select it. The selected point is indicated with a black circle.

To deselect the point, tap off it. Alternatively, tap and hold on the screen and then select *Clear selection*.

2. Tap *Delete*.

Tip - To restore deleted points, tap and hold on the screen and then select *Restore deleted points*.

Note - When you select a point for deletion, the instrument target will be the design position for that point. If you select *Store* immediately after deleting the point, the instrument remeasures the design position for the deleted point.

Position in tunnel

Use position in tunnel to:

- Measure a position at any station within the tunnel.
- Compare the position with the design parameters of the tunnel.

To use position in tunnel:

1. Tap *Survey*, select a survey style and start a survey.
From the Trimble Access menu tap *Settings / Survey styles* to edit an existing style or to define a new style.
2. Tap *Position in Tunnel*.
3. Select a tunnel from the list.

Tips

- To add files from another folder to the list, tap *Add*, navigate to the required folder and then select the file(s) to add.
- To view a popup window showing information including (where applicable), horizontal and vertical offsets, northing, easting, elevation, surface name, and code information for an item, tap any of the following:

Item	Shown as
Alignment	Red cross
Offset alignment	Smaller green cross
Pivot position	Circular green icon
Design points	Blue circles
Vertex point	Short green line

When using an instrument equipped with a laser pointer, the instrument is automatically set to DR tracking mode with the laser pointer on. The cross section for the current position is displayed on screen.

Tip - To disable DR mode, set a target height, or make other changes to the instrument setting, tap the arrow at the right of the screen to access the status bar.

4. If you are using a:
 - Servo or robotic instrument, tap the template surface to measure relative to.
 - Mechanical instrument, tap *Measure* and then tap the template surface to measure relative to.

Tip - Alternatively use the tap and hold menu to select the surface from a list.

5. Point the instrument at the position you want to measure.

From the tap and hold menu you can configure the *Settings* and *Tolerances*.

Tip - If you can't measure to the tunnel surface with DR, then you can [measure to a prism](#) that is offset perpendicular to the design surface, where the target height is applied perpendicular to the tunnel profile. To do this, select the *Apply target height perpendicular to profile* option

from [Settings](#). In the case where the prism is held against the tunnel surface you would enter the prism radius as the target height.

If you are using a:

- Servo or robotic instrument, information on the current position and its relationship to the selected template surface appears at the bottom of the screen.
- Mechanical instrument, tap *Measure* to view information on the current position and its relationship to the selected template surface at the bottom of the screen.

Tip - If, when measuring without a prism, your current position (displayed as a cross) fails to update, then ensure the *Apply target height perpendicular to profile* option from [Settings](#) is not selected.

Information on the current position appears at the bottom of the screen. See [Current position information](#).

6. Tap *Store* to record the current position in the job's database.

Setting out positions

Use *Tunnel/Set out* to set out predefined positions in a tunnel. To define set out positions in a tunnel, see [Tunnel set out positions](#).

Note - When setting out positions using a servo or robotic instrument, *Tunnels* attempts to navigate you to the defined position. Often this is not possible and the software instead locates a position on the tunnel surface that is on the selected station. The location of this position depends on the method used to define the set out position. For more information on each method for defining a set out position in a tunnel, see [Tunnel set out positions](#).

The following diagram and table describes the set out of blast holes.

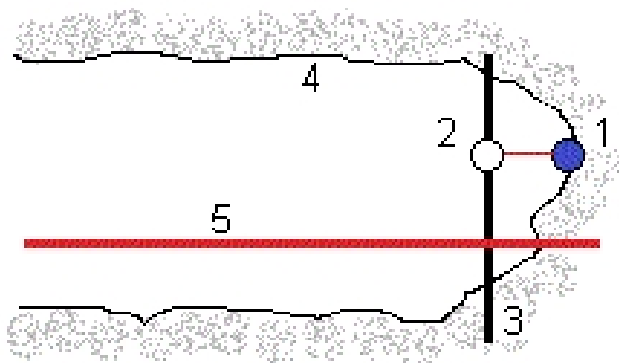

- | | | | |
|---|---------------------|---|------------------|
| 1 | Blast hole position | 4 | Tunnel surface |
| 2 | Design position | 5 | Tunnel alignment |
| 3 | Design surface | | |

The following diagram and table describes the set out of positions defined by the radial (including multiple radial), horizontal, and vertical methods.

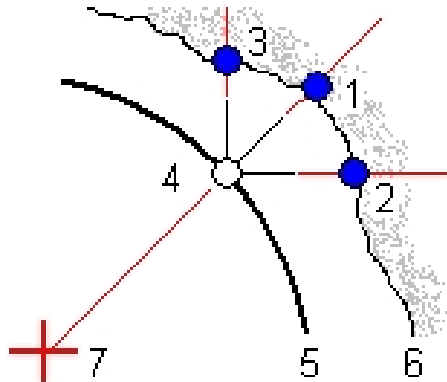

- | | |
|---------------------------------------|------------------------------|
| 1 Set out position defined radial | 5 Design surface |
| 2 Set out position defined horizontal | 6 Tunnel surface |
| 3 Set out position defined vertical | 7 Center for radial position |
| 4 Design position | |

Setting out previously defined positions in a tunnel

1. Tap *Survey*, select a survey style and start a survey.
From the Trimble Access menu tap *Settings / Survey styles* to edit an existing style or to define a new style.
2. Tap *Set out*.
3. Select a tunnel from the list.
Tip - To add files from another folder to the list, tap *Add*, navigate to the required folder and then select the file(s) to add.
4. To define the station range, use one of the following methods to select stations:
 - Key values into the *Start station* and *End station* fields.
 - In the *Start station* and *End station* fields, select *List* from the pop-up menu and then select values from the list.
 - Highlight the *Start station* field, point the instrument to the required start point and then tap *Measure*. Repeat the process for the *End station*.
Tip - To survey in the direction of decreasing station, enter a *Start station* value that is greater than the *End station* value.
5. Enter the required station interval.
 - The 0 based method is the default method and gives station values that are multiples of the station interval. For example, if the start station is 2.50 and the station interval is 1.00, the 0 based method produces stations at 2.50, 3.00, 4.00, 5.00, and so on.

- The Relative method gives station values relative to the start station. For example, if the start station is 2.50 and the station interval is 1.00, the Relative method produces stations at 2.50, 3.50, 4.50, 5.50, and so on.
6. Tap *Next* to view the selected station range in the plan view. The plan view automatically zooms to the defined range.

The graphical display shows	As
Horizontal alignment	Black line
Offset alignment (where applicable)	Green line
Current station	Red circle
Selected stations	Solid blue circle
Instrument position	Solid black circle
Direction instrument is pointing	Dashed red line

Tips

- Tap and hold on a position on the alignment (or offset alignment if available) to browse its station, northing, easting, and elevation.
 - Tap *Calc* from the second row of softkeys to calculate the grid and tunnel coordinates. Use this option to confirm the definition before surveying the tunnel.
 - Tap the pan softkey and then use the left, right, up, and down arrow keys on the controller keyboard to pan around the screen.
7. Select a station to measure using one of the following methods:
- Tap an up or down arrow on the controller keyboard.
 - Tap an individual station.
 - Tap and hold on the screen and then select a station from the list in the *Select stations* field.

The selected station appears as a red circle.

8. Tap *Next*.
9. From the cross section view, do one of the following to select a position to set out:
- Tap an individual set out position.
 - Use the left and right arrow on the controller keyboard.

Tips

- To automate the set out of multiple blast holes, from the tap and hold menu select *All blast holes*.
- Tap and hold on the alignment, offset alignment, set out points (shown as a hollow black circle for a blast hole and with a line that is defined by the origin of the position for setout points defined as radial, horizontal or vertical), design points (shown as solid blue circles), and the vertex point (shown as a short green line) to browse its horizontal and vertical offsets, northing, easting, elevation, surface name, and code.

- To view a popup window showing information including (where applicable), horizontal and vertical offsets, northing, easting, elevation, surface name, and code information for an item, tap any of the following:

Item	Shown as
Alignment	Red cross
Offset alignment	Smaller green cross
Pivot position	Circular green icon
Set out positions	A hollow black circle for the setout point for a blast hole. For setout points defined as radial, horizontal or vertical, the circle includes a line defined by the origin of that position.
Design points	Blue circles
Vertex point	Short green line

- Tap *Auto* to configure the set out *Tolerances*.
- Tap *Accept* to configure the scan *Settings*.
- Set out the selected position. If you are using a:
 - Servo or robotic instrument
 - Tap *Auto* to set out the selected position.
 - If the *Position tolerance* has not been defined, the *Tolerances* screen appears. Complete the required fields and then tap *Accept*. If the *Start point* name has not been defined, the *Settings* screen appears. Complete the required fields and then tap *Accept*.
The instrument automatically turns to the selected position by an iterative process indicated by the progress bar at the top left of the screen. If you are setting out blast holes and you selected *All blast holes*, the instrument turns to the first defined blast hole.
 - When the position is found you are instructed to mark the point indicated by the laser on the tunnel surface.
If you are using an instrument that is not equipped with a laser pointer, the point is not indicated on the tunnel surface. To mark the tunnel surface, tap *Switch to* and select *Video* (the *Video* screen must already be open). Use the inner crosshair in the *Video* screen as a guide to mark the position on the tunnel surface. (Do not use the outer crosshair as it is less precise.) To return to the *Set out* screen, tap *Switch to* and select *Set out*. Alternatively, add the *Video* and *Set out* screens to your *Favorites* list.
If you are using a Trimble S8 or S9 total station equipped with the high-power laser pointer, tap *3R Laser* to enable the high-power laser pointer and then tap *Measure* to measure the position.

- d. If you are setting out *All blast holes*, the instrument turns to the next blast hole and so on until all blast holes have been set out.

If the position cannot be found within the position tolerance, the software shows *Failed* above the delta display. If you are setting out *All blast holes*, the software skips the position and moves to the next blast hole. See [Settings](#) to specify *Start delay* and *Mark delay* values.

Tip - If you want to manually locate the set out position, use the *Turn* softkey to point the instrument at the selected set out position and then fine tune the position manually

- Mechanical instrument

Tap *Turn*, manually turn the instrument to the required delta values and then tap *Measure*.

Tip - If the instrument struggles to get a measurement due to, for example, reflective or dark surfaces, increase the value in the *EDM timeout* field in the [Settings](#) screen.

Information on the current position and its relationship to the selected set out position appears at the bottom of the screen. See [Current position information](#).

13. Tap *Store* to record the measured position. The stored position is indicated by a solid black circle.

After a scan is completed, you can do the following:

- To review a summary for each station, return to the plan view, tap and hold on the screen and then select *Results*.
- To see details for the current station, return to the cross section view, tap and hold on the screen and then select *Details*. See also [Review tunnel](#).
- During a conventional survey, you can use the tap and hold menu in the map to quickly measure a check point. If there are no points selected, *Check backsight* is available; if one point is selected *Check shot* is available. Alternatively, to measure a check shot from any screen, press [CTRL + K] on the controller.

Scan settings and tolerances

You can configure:

- [Settings](#)
- [Tolerances](#)

Settings

The available fields depend on the survey method.

Tip - To improve performance when surveying, configure the *EDM timeout* field if it is available. If the instrument struggles to get a measurement due to, for example, reflective or dark surfaces, increase the EDM timeout. This setting is not available when connected to a Trimble SX10 scanning total station because the EDM times out automatically.

Auto scan

- Set the *Start point* name, *Point code* and *Scan interval*. Points to be scanned are defined by the scan interval, and include the start and end points that define each element in the template surface.
- Use the *On station adjustment* option to control where the position will be measured when the tunnel surface does not match the design. If selected, *Auto OS* appears at the top left of the screen. You must specify a station tolerance if using this option.
- When measuring manually with a prism select the *Apply target height perpendicular to profile* option from *Settings*. This option enables a position to be measured perpendicular to the tunnel profile when using a prism by entering the prism radius as the target height.
- If you are using a Trimble VX Spatial Station, select the *VX scanning* option for improved scanning performance.
- Select *Instrument perspective profile display* to display the tunnel profile in the direction the instrument is facing. This option is especially useful when you are facing in the direction of decreasing station, as the tunnel profile is then displayed in the same sense that the instrument is pointing, rather than always assuming you are facing in the direction of increasing station.

Position in tunnel

- Set the *Point name*.
- When measuring with a prism select the *Apply target height perpendicular to profile* option from *Settings*. This option enables a position to be measured perpendicular to the tunnel profile when using a prism by entering the prism radius as the target height.
- Select *Instrument perspective profile display* to display the tunnel profile in the direction the instrument is facing. This option is especially useful when you are facing in the direction of decreasing station, as the tunnel profile is then displayed in the same sense that the instrument is pointing, rather than always assuming you are facing in the direction of increasing station.

Set out

- Set the *Point name*.
- If you are setting out all blast holes specify the *Start delay* and *Mark delay* values to control the automated set out process. The *Start delay* gives you time to walk to the location of the first point to be marked. The *Mark delay* is the length of time, in seconds, that the laser point flashes once the position is found.
- Select *Instrument perspective profile display* to display the tunnel profile in the direction the instrument is facing. This option is especially useful when you are facing in the direction of decreasing station, as the tunnel profile is then displayed in the same sense that the instrument is pointing, rather than always assuming you are facing in the direction of increasing station.

Guidelines

For all survey methods you can display guide lines in the cross section view. Select:

- *Display profile vertical center line* to display a vertical green line through the alignment or, if the alignment has been offset, the offset alignment.
- *Display spring line* to display a horizontal green line through the alignment or, if the alignment has been offset, the offset alignment.
- *Display alignment vertical center line* to display a vertical orange line through the alignment.
- *Display floor line* to display a horizontal orange line through the alignment or, if the alignment has been offset, the offset alignment.

Note - *The spring and floor lines can be offset vertically (up and down), relative to the alignment or, if the alignment has been offset, the offset alignment.*

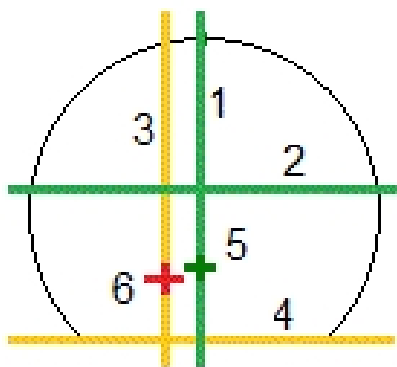

- | | |
|---|--|
| 1 Profile vertical center line | 4 Floor line (offset vertically from the offset alignment) |
| 2 Spring line (offset vertically from the offset alignment) | 5 Offset alignment |
| 3 Alignment vertical center line | 6 Alignment |

Tolerances

The available fields depend on the survey method.

- For *Auto scan*, set the *Station*, *Overbreak* and *Underbreak tolerances*, and the number of *Iterations*.
- For *Position in tunnel*, set the *Overbreak* and *Underbreak tolerances*.
- For *Set out*, set the *Position tolerance* and the number of *Iterations*.

Current position information

Information on the current position and, if applicable, its relationship to the selected set out position appears at the bottom of the screen.

To scroll through the values, tap the arrow to the left of the text. Refer to the diagrams and the table below for a description of the information that may appear.

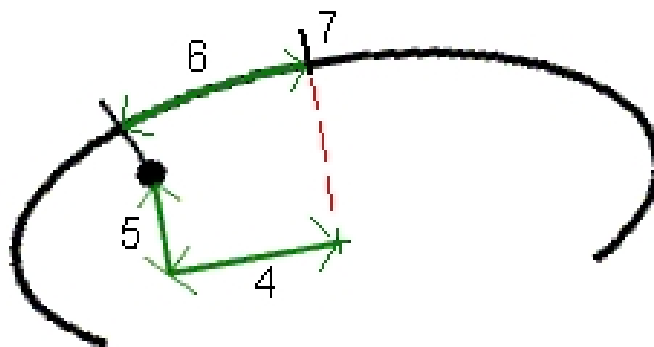
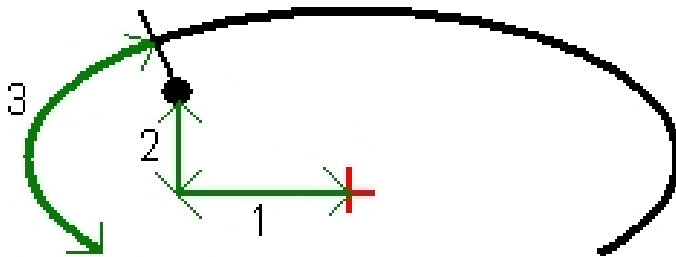

Number	Value	Description
-	Station	The station of the current position in terms of the tunnel design.
-	Under/Overbreak	The underbreak or overbreak of the current position in terms of the selected template surface. Appears in red if it is out of tolerance.
-	Rotation	The rotation value of the cross section at the current position.
-	Delta station	The station of the current position in terms of the tunnel design.
-	Delta offset	The radial difference between the measured position and the set out position. Appears in red if it is greater than the <i>Position tolerance</i> .
-	Rotation	The rotation value of the cross section at the current position.
1	Hx. offset	The horizontal offset of the current position from the alignment (shown as a red cross). If the alignment has been offset, the horizontal offset is from the offset alignment (shown as a smaller

Number	Value	Description
		green cross).
2	Vt. offset	The vertical offset of the current position from the alignment (shown as a red cross). If the alignment has been offset, the vertical offset is from the offset alignment (shown as a smaller green cross). May be either perpendicular or true vertical, depending on the template position options in the Tunnel design.
3	Profile dist.	The profile distance of the current position measured along the selected template surface from its start point.
4	Hx. off. (rot)	The horizontal offset of the current position from the rotated alignment (shown as a green cross) and rotated with the tunnel.
5	Vt. off. (rot)	The vertical offset of the current position from the rotated alignment (shown as a green cross) and rotated with the tunnel. Maybe either perpendicular or true vertical, depending on the template position options in the tunnel design.
6	Dist. to vertex	The profile distance from the vertex (7) to the current position. The vertex (shown as a black line) is defined by the intersection of a perpendicular line from the rotated alignment (shown as a green cross) to the tunnel roof.
-	Northing	Northing of the current position.
-	Easting	Easting of the current position.
-	Elevation	Elevation of the current position.

Machine positioning

To position a machine relative to a tunnel:

1. Tap *Position*, select a survey style and start a survey.
From the Trimble Access menu tap *Settings / Survey styles* to edit an existing style or to define a new style.
2. Select a tunnel from the list.
Tip - To add files from another folder to the list, tap *Add*, navigate to the required folder and then select the file(s) to add.
3. From the *Machine positioning* screen enter the *Nominal station* of the tunnel face by either:
 - Keying in a value.
 - Measuring a station by selecting *Measure*.
4. Enter a *Drill depth*.

Notes

- The Tunnels calculates positions on the horizontal alignment at the nominal station and at the station defined by the drill depth. A refline is calculated using these two positions.
 - The refline cannot be calculated if the:
 - nominal station is before the start of the tunnel
 - drill depth is zero
 - drill depth results in a station beyond the end of the tunnel
5. Optionally, enter *Construction offsets*. Two offsets can be specified:
 - *Transverse offset* - offset the reference line left or right of its computed position
 - *Vertical offset* - offset the reference line up or down from its computed position
 6. Tap *Next*.
 7. The calculated station and elevation values and coordinates for the two positions defining the refline are displayed along with the azimuth and grade of the refline. Use these values to confirm the refline.
 8. Tap *Next*.
 9. The transverse and vertical offsets from a measured point to a position calculated perpendicular onto the refline are displayed, along with the longitudinal offset from the calculated position on the refline to the calculated position at the tunnel face. Use these deltas to position the machine.

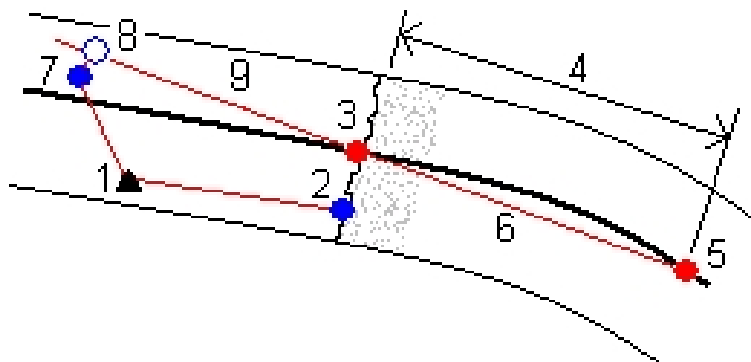

1 Instrument position	6 Refline
2 Nominal station at tunnel face	7 Measured point
3 Calculated position on the alignment projected from 2	8 Calculated position on refline projected from 7
4 Drill depth	7 to 8 Transverse and Vertical offsets
5 Calculated position on the alignment at drill depth	9 Longitudinal offset

10. Tap *Finish*.

Tip - Tap *Back* to return to the *Refline definition* screen to confirm the definition or *Back* again to confirm the nominal station and / or drill depth.

Tip - During a conventional survey, you can use the tap and hold menu in the map to quickly measure a check point. If there are no points selected, *Check backsight* is available; if one point is selected *Check shot* is available. Alternatively, to measure a check shot from any screen, press [CTRL + K] on the controller.

On station adjustment

From the *Settings* screen use the *On station adjustment* option to control the position that will be measured when the tunnel surface does not match the design, that is, the surface is in either underbreak or overbreak.

Refer to the following diagram and table that illustrates an underbreak situation.

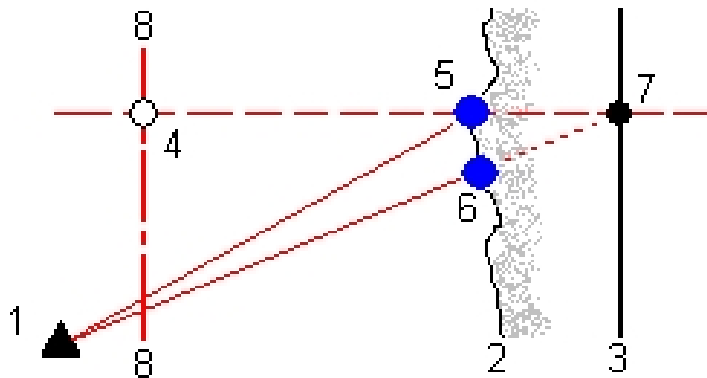

- | | |
|-----------------------|---|
| 1 Instrument position | 5 Measured position when <i>On station adjustment</i> is selected |
| 2 Tunnel surface | 6 Measured position when <i>On station adjustment</i> is not selected |
| 3 Tunnel design | 7 Design position |
| 4 Station | 8 Horizontal alignment |

The overbreak is similar to the underbreak situation.

Set out position tolerance

The *Position tolerance* is defined as the radius of a cylinder that passes through the axis of the set out position. If the measured point is within this cylinder the point is within tolerance.

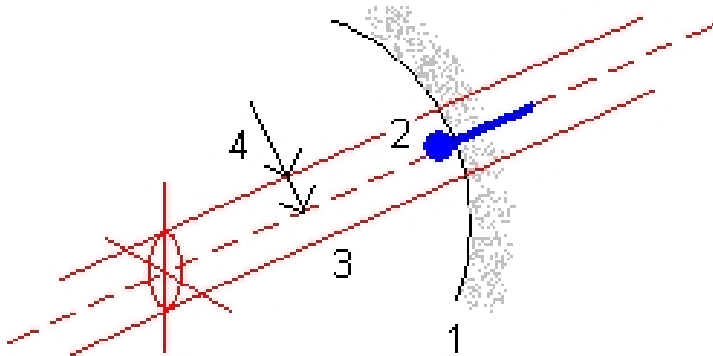

- | | | | |
|---|------------------|---|--------------------|
| 1 | Tunnel surface | 3 | Axis of cylinder |
| 2 | Set out position | 4 | Radius of cylinder |

Measuring a position with a prism

To measure a position perpendicular to the tunnel profile using a prism:

1. From the tap and hold menu, select *Settings*.
2. Select the *Apply target height perpendicular to profile* option.
3. Tap *Accept*.
4. From the status bar, enter the prism radius as the target height.

Tip - You can use the prism on a pole held perpendicular to the tunnel design surface, where the target height is used to project the prism measurement perpendicular onto the tunnel surface.

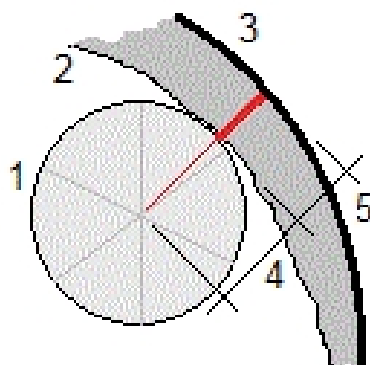

3 Survey Tunnels

- 1 Prism
- 2 Tunnel surface
- 3 Design tunnel
- 4 Target height (prism radius)
- 5 Overbreak

Review Tunnels

Review

Use *Review* to see the survey results for:

- *Scanned* and manually measured points
- *Set out* points

Reviewing scanned points

1. Tap *Review* select a tunnel from the list, and then tap *OK*. The plan view of the tunnel appears. Stations with no scan points outside tolerance appear as solid green circles, while those with errors appear as solid red circles.

Tip - Tap the pan softkey and then use the left, right, up, and down arrow keys on the controller keyboard to pan around the screen.

2. By default the first station is selected. To select another station to review, do one of the following:
 - Press an up or down arrow key on the controller keyboard.
 - Tap an individual station.
 - Tap and hold on the screen and then select a station from the list in the *Select stations* field.

The selected station appears as a red circle.

3. To view a summary for each station, select *Results* and then expand the station that you want to review.
 - To view the number of points scanned, the number of points within tolerance, and the number of points outside tolerance, expand the *Scanned points* record.
 - To view the number of points in overbreak, underbreak, and delta station, expand the *Points outside tolerance* record.
4. Tap *Close*.
5. To view the cross section for the current station, select the icon at the bottom right of the screen or press the **Tab** key. From the cross section view, tap and hold on the screen and then select *Scanned points*. The selected mode, *Scan*, is shown at the top left of the screen.

Each scanned position appears as a green circle if it is within tolerance or as a red circle if it is not within tolerance.

6. The point name, overbreak / underbreak, and delta station values appear for the current position. Tap other points to view their delta values. To deselect a point, tap off the point. Alternatively, tap and hold on the screen and then select *Clear selection*.

Tips

- To delete a selected point, tap the backspace key. Alternatively, tap and hold on the screen and then select *Delete point*. To restore deleted points, tap and hold on the screen and then select *Restore deleted points*.
 - To edit a selected point, tap and hold on the screen and then select *Edit point*. Enter an *Under/overbreak correction* value. The displayed *Underbreak / Overbreak* value updates to reflect the correction. The correction is applied perpendicular to the tunnel design and is used to modify the original observation and calculate new HA, VA, and SD values. A note is attached to the cross section record in the job and records the name of the point edited, the original under/overbreak value, the correction applied, the new under/overbreak value and the original HA, VA and SD values. Use this option to correct scan points that have been measured to an obstacle other than the tunnel surface, for example ventilation ducting.
7. To view details for a selected point, tap *Details*. Expand the point that you want to review: The Offsets (true), Offsets (rotated), Grid coordinates, Underbreak / Overbreak, and Delta station values are shown for each point.
 - To view the horizontal and vertical offsets from the intersection of the horizontal and vertical alignments to the scanned position, expand the *Offsets (true)* record.
 - To view the rotated horizontal and vertical offsets from the intersection of the rotated horizontal and vertical alignments to the scanned position, expand the *Offsets (rotated)* record.
 - To view the north, east, and elevation values for the measured positions, expand the *Grid* record.
 8. Tap *Close*.

Tip - When reviewing a tunnel the number of points within or outside tolerance and their delta values is controlled by the tolerance values defined when the tunnel was scanned. To edit these tolerance values after a survey, select *Tolerance* from the tap and hold menu at the plan or cross section review screens. This option is useful if incorrect values were specified for the survey.

9. Select another station to review using one of the following methods:
 - Tap and hold on the screen and then select a station from the list in the *Select stations* field.
 - Tap an individual station.
 - Tap an up or down arrow on the controller keyboard.

10. Tap *Esc*.

Note - All scanned and measured points are face 1 measurements and are stored in the database. To review them, go to *Jobs / Review job*.

Reviewing set out points

1. Select *Review* select a tunnel from the list, and then tap *OK*. The plan view of the tunnel appears.

Tip - Tap and hold on the pan softkey to use the left, right, up, and down arrow keys to pan around the screen.

2. By default the first station is selected. To select another station to review, do one of the following:
 - Tap and hold on the screen and then select a station from the list in the *Select stations* field.
 - Tap an individual station.
 - Press an up or down arrow key on the controller keyboard.

The selected station appears as a red circle.

3. To view a summary for each station, select *Results*, and expand the station that you want to review.
 - To view the number of points setout and the number of points within tolerance expand the *Set out points* record.

4. Tap *Close*.

5. To view the current cross section showing the design tunnel and set out positions, select the icon at the bottom right of the screen or press the **Tab** key. From the cross section view, tap and hold on the screen and then select *Set out points*. The selected mode, *Set out*, is shown at the top left of the screen.

Measured set out positions are indicated by a solid black circle.

6. The point name, horizontal and vertical offsets are displayed for the current position. Tap other points to view their delta values.

7. To view details for a selected point, tap *Details*. Expand the point that you want to review. For each point, the Offsets (true), Offsets (rotated), Grid coordinates, and Delta station values are displayed.
 - To view the horizontal and vertical offsets from the intersection of the horizontal and vertical alignments to the measured position, expand the *Offsets (true)* record.
 - To view the horizontal and vertical offsets from the intersection of the rotated horizontal and vertical alignments to the measured position, expand the *Offsets (rotated)* record.
 - To view the north, east, and elevation values for the measured positions, expand the *Grid* record.

8. Tap *Close*.

9. To select another station to review, do one of the following:
 - Tap and hold on the screen and then select a station from the list in the *Select stations* field.
 - Tap an individual station.
 - Tap an up or down arrow on the controller keyboard.

4 Review Tunnels

The selected station appears as a red circle.

10. Tap *Esc*.

Note - *All set out points are face 1 measurements and are stored in the database. To review the points, go to Jobs / Review job.*

Reports

Generating a report

Use the *Report* option to create custom ASCII files on the controller while in the field. Use the predefined formats or create your own custom formats. With custom formats, you can create files of almost any description. Use these files to check data in the field, or to produce reports, which you can transfer from the field to your client or to the office for further processing with the office software.

You can modify a predefined format to meet your specific requirements, or use it as a template to create a completely new custom ASCII export format.

Creating a report of survey data

1. Open the job that contains the data to export.
2. From the main menu, tap *Report*.
3. In the *File format* field, specify the type of file to create.
4. Tap  to select an existing folder or create a new one.
5. Enter a filename.

By default, the *File name* field shows the name of the current job. The filename extension is defined in the XSLT style sheet. Change the file name and extension as required.

6. If more fields are displayed, complete them.

You can use the XSLT style sheets to generate files and reports based on parameters that you define. For example, when generating a Stakeout report, the *Stakeout horizontal tolerance* and the *Stakeout vertical tolerance* fields define acceptable stakeout tolerances. When generating the report you can stipulate the tolerances, then any stakeout delta greater than the defined tolerances appears in color in the generated report.

7. To automatically view the file after you create it, select the *View created file* check box.
8. To create the file, tap *Accept*.

Note - When the selected XSLT style sheet is applied to create the custom export file, the processing is all carried out in the program memory available on the device. If there is not enough memory to enable the creation of the export file, an error message will be displayed and no export file will be created.

The following factors affect whether the report file can be created:

1. The amount of program memory available to the device.
2. The size of the job being exported.
3. The complexity of the style sheet being used to create the export file.
4. The amount of data being written to the export file.

If it is not possible to create the export file on the controller, download the job as a JobXML file to a computer.

To create the export file from the downloaded JobXML file using the same XSLT style sheet, use the ASCII File Generator utility program (available from *Trimble Access Downloads* (www.trimble.com/support_trl.aspx?Nav=Collection-62098)).